

**MCRP 3-10E.6
(Formerly MCWP 3-16.7)**

Marine Artillery Survey Operations



US Marine Corps

DISTRIBUTION STATEMENT A: Approved for public release; distribution is unlimited.

PCN 144 000260 00

CD&I (C 116)

2 May 2016

ERRATUM

to

MCWP 3-16.7

MARINE ARTILLERY SURVEY OPERATIONS

1. Change all instances of MCWP 3-16.7, *Marine Artillery Survey Operations*, to MCRP 3-10E.6 *Marine Artillery Survey Operations*.
2. Change PCN 143 000087 00 to PCN 144 000260 00.
3. File this transmittal sheet in the front of this publication.

PCN 144 000260 80

To Our Readers

Changes: Readers of this publication are encouraged to submit suggestions and changes that will improve it. Recommendations may be sent directly to Commanding General, Marine Corps Combat Development Command, Doctrine Division (C 42), 3300 Russell Road, Suite 318A, Quantico, VA 22134-5021 or by fax to 703-784-2917 (DSN 278-2917) or by E-mail to morgann@mccdc.usmc.mil. Recommendations should include the following information:

- Location of change
 - Publication number and title
 - Current page number
 - Paragraph number (if applicable)
 - Line number
 - Figure or table number (if applicable)
- Nature of change
 - Add, delete
 - Proposed new text, preferably double-spaced and typewritten
- Justification and/or source of change

Additional copies: A printed copy of this publication may be obtained from Marine Corps Logistics Base, Albany, GA 31704-5001, by following the instructions in MCBul 5600, *Marine Corps Doctrinal Publications Status*. An electronic copy may be obtained from the Doctrine Division, MCCDC, world wide web home page which is found at the following universal reference locator: <http://www.doctrine.usmc.mil>.

Unless otherwise stated, whenever the masculine gender is used, both men and women are included.

DEPARTMENT OF THE NAVY
Headquarters United States Marine Corps
Washington, D.C. 20380-1775

28 January 2002

FOREWORD

Marine Corps Warfighting Publication (MCWP) 3-16.7, *Marine Artillery Survey Operations*, sets forth the doctrinal foundation and technical information that Marines need to provide accurate and timely survey support. It covers a broad spectrum of issues from general knowledge to Marine-specific equipment.

As one of the five requirements for accurate predicted fire, survey is critical to the success of artillery (and ultimately maneuver) on the modern battlefield. Marine artillery surveyors support firing units *and* target acquisition assets, enabling indirect fires to mass effectively and deliver surprise observed fires and effective unobserved fires.

This publication applies to Marine air-ground task force (MAGTF) artillery commanders, their staffs, and personnel in the 0844/48 military occupational specialty (fire direction controlman), and field artillery operations chief billets, from battery through regiment, including infantry mortarmen.

Reviewed and approved this date.

BY DIRECTION OF THE COMMANDANT OF THE MARINE CORPS

EDWARD HANLON, JR.
Lieutenant General, U.S. Marine Corps
Commanding General
Marine Corps Combat Development Command

DISTRIBUTION: 143 000087 00

MARINE ARTILLERY SURVEY OPERATIONS

TABLE OF CONTENTS

Chapter 1. Fundamentals

Section I. Mission and Duties

Survey Operation Steps	1-1
Planning	1-1
Coordination	1-2
Field Work	1-2
Computations	1-2
Echelons of Survey	1-2
Regiment Survey Section	1-2
Establishing Initial Control	1-2
Recovering Existing Control	1-2
Priorities of Survey	1-3
Survey Information Center	1-4
Mapping, Charting, and Geodesy After Action Report	1-4
Evaluation	1-4
Maintenance	1-4
Dissemination	1-6
Battalion Survey Section	1-6
Areas of Concern	1-7
Categories of Starting Control	1-7
Marking and Witnessing Stations	1-8
Dissemination of Survey Data	1-8
Battery Survey Section	1-8
Collective Duties	1-8
Survey Officer	1-8
Survey Chief	1-9
Conventional Team (Party) Chief	1-9
Survey Computer	1-9
Instrument Operator	1-9
Recorder/Computer	1-9
PADS Operator (PADS Team Chief)	1-9
Assistant PADS Operator	1-10

Section II. Survey Accuracy Levels and Requirements

Geodetic Control Surveys	1-10
Artillery Survey	1-10
Relative Position Accuracy	1-10
Probable Error Values	1-12
Relative Azimuth Accuracy (Fourth Order)	1-12
Relative Azimuth Accuracy (Fifth Order)	1-12
Required Survey Formats	1-12

Section III. Converting to Common Control

Comparisons: Why We Convert	1-13
Azimuth	1-13
Radial Error	1-14
Elevation	1-14
Swinging the Grid	1-14
Recomputing the Survey	1-14
Computing Individual Legs	1-15
Determining the Common Azimuth of a Critical Line	1-15
Sliding the Grid	1-15
Swinging and Sliding the Grid	1-16
Leveling the Grid	1-17

Chapter 2. Planning

The Artillery Fire Plan	2-1
The Survey Plan	2-2
Situation	2-2
Mission	2-2
Execution	2-2
Administration and Logistics	2-2
Command and Signal	2-2
Mission, Enemy, Terrain and Weather, Troops and Support Available-Time Available	2-2
Mission	2-2
Enemy	2-2
Terrain and Weather	2-3
Troops and Support Available	2-3
Time Available	2-3
Space and Logistics	2-3
Position and Azimuth Determining System	2-4
Traverse	2-4
Intersection	2-4
Astronomic Observations	2-4
RTK/OTF GPS Survey	2-4
Static/Rapid Static GPS Survey	2-5
The Environment	2-5
Arctic Areas and Cold Weather Conditions	2-5
Desert Areas	2-6
Jungle Areas	2-6
Urban Areas	2-6
Mapping, Charting, and Geodesy	2-7
BAMCIS	2-7
Begin Planning	2-7
Arrange for Reconnaissance	2-7
Make Reconnaissance	2-7
Complete the Plan	2-7
Issue the Order	2-8
Supervise	2-8
Survey Sketch	2-8

Chapter 3. Basic Geodesy

Section I. The Geodetic System

The Geoid	3-1
Ellipsoid Defining Parameters	3-1
Reference Ellipsoid	3-3
Geoid Separation	3-3
Ellipsoid Height	3-4
Datums	3-4
Vertical Datums	3-4
Horizontal Datums (Geodetic Datums)	3-5
Multiple Datum Problems	3-5
Seven Parameter Model	3-6
Five Parameter Model	3-6
WGS 72 to WGS 84	3-6
NAD 83 TO WGS 84	3-6
Multiple Regression Equations	3-7
Lateral Shift Method	3-7

Section II. Coordinate Systems

Three-Dimensional Positioning	3-7
Cartesian Coordinates System	3-7
Geographic Coordinates	3-8
Geodetic Coordinates	3-10
Astronomic Coordinates	3-10
The Prime Meridian	3-11
Angular Measurements	3-11
Deflection of the Vertical	3-12

Chapter 4. Map Projections and Grid Systems

Section I. Map Projections

Prescribed Projections	4-1
Scale Factor	4-2
Map Scale	4-2
Mercator Projection	4-3
Transverse Mercator Projection	4-4
Gauss-Kruger Projection	4-6
Polar Stereographic Projection	4-6
Lambert Conformal Conic Projection	4-6
Oblique Mercator Projection	4-7
New Zealand Map Grid Projection	4-8
Cassini Projection	4-8

Section II. Grid Systems

Universal Transverse Mercator Grid System	4-12
Military Grid Reference System	4-16
100,000-Meter Square Identifier	4-18
MGRS Grid Coordinates	4-18
Nonstandard Grids.	4-19
World Geodetic Reference System	4-19
User-Defined Grid Systems	4-19

Chapter 5. Conventional Equipment

Section I. T-2E Theodolite

Components.	5-1
Telescope.	5-2
Accessories	5-3
Setting Up the Tripod GST-20	5-3
Mounting the T-2E on the Tripod	5-3
Plumb and Level the T-2E	5-3
Eliminating Parallax and Adjusting Focus	5-4
Pointings	5-5
Reading the Scales	5-6
Upper Window	5-6
Central Window	5-6
Bottom Window.	5-7
Coincidence	5-7
Circle Readings	5-7
Setting the Horizontal Circle.	5-7
Initial Circle Setting.	5-8
Orienting the Scale.	5-8
Horizontal Angles	5-8
Position Angle	5-8
Multiple Angles	5-9
Circle Closure.	5-9
Two-Position Angle	5-9
Vertical Angles	5-9
Vertical Index.	5-9
Determining Vertical Readings	5-10
Reciprocal Vertical Angles	5-10
March Ordering.	5-10
Tests and Adjustments	5-11
Plate Level	5-11
Circular Bubble	5-11
Optical Plumb.	5-11
Horizontal Collimation.	5-12
Vertical Collimation (Index Error).	5-12
Artificial Illumination	5-13
Maintenance	5-14

Section II. DI 3000 Distomat

Range and Accuracy	5-14
Power Sources	5-15
Mounting the DI 3000 to a T-2E	5-15
Control Panel	5-16
Operation	5-17
System Settings	5-17
Prism Constant (Millimeters)	5-17
Units	5-17
Decimal Fix.	5-17
Scale Correction (Parts Per Million)	5-18
Temperature and Barometric Pressure	5-18
Relative Humidity	5-18
Distance Measurement.	5-18
Parallelism: DI 3000 to Telescope.	5-19
Checking Parallelism	5-19
Adjusting Parallelism	5-20

Section III. Target Set

Components	5-20
Tribrach (GDF22).	5-20
Target Carrier (GZR2)	5-20
Target Plate (GZT1)	5-21
Illumination Kit.	5-21
Mounting	5-21
Plumb and Level	5-21
Mounting the Target Plate	5-22
Tests and Adjustments	5-22
Plate Level	5-23
Circular Bubble.	5-23
Optical Plumb	5-23
Maintenance.	5-23

Chapter 6. Traverse

Section I. Fundamentals

Open Traverse	6-1
Closed Traverse	6-1
Directional Traverse.	6-2
Sources of Control Data.	6-2
Field Work	6-3
Stations	6-3
Measurements	6-3
Distances	6-4
Traverse Legs.	6-5

Section II. Field Notes

Survey Recorder Duties	6-5
General Rules	6-6
Recording a One-Position Angle.	6-8
Heading and Column Titles	6-8
STA and T Columns.	6-8
Recording Field Data	6-9
Recording a Two-Position Angle	6-10
Heading and Column Titles	6-10
STA and T Columns.	6-10
Recording Field Data	6-10
Closing an Angle on the Horizon	6-11
Heading and Column Titles	6-11
STA and T Columns.	6-11
Recording Field Data	6-11
Recording Reciprocal Vertical Angles	6-12
Recording Angles from an M2A2 Aiming Circle.	6-13
Heading and Column Titles	6-13
STA and R Columns	6-14
Recording Field Data	6-14
Recording Intersection Method.	6-14
Correcting Errors and Voiding	6-16
Security	6-16
Storing the Recorder's Book.	6-17

Section III. Trigonometry

Extending Azimuth	6-18
Azimuth-Angle Relationship	6-18
Azimuth to the Rear	6-18
Solutions of Right Triangles	6-18
Forming the Coordinate Triangle.	6-18
Forming the Elevation Triangle	6-20
Trigonometric Functions To Compute a Traverse	6-20
Determining Coordinate and Elevation Differences	6-20
Determining the Coordinates and Elevation of the Forward Station	6-21
Computing the Traverse	6-22

Section IV. Closure

Radial Error.	6-22
Computing Radial Error.	6-23
Allowable Radial Error	6-24
Excessive Radial Error.	6-24
Elevation Error	6-24
Azimuth Error	6-25
Fourth Order.	6-25
Fifth Order	6-25
Accuracy Ratio	6-26
Specifications	6-26

Section V. Adjustment

Azimuth 6-27
 Determining Azimuth Correction 6-27
 Applying Azimuth Correction 6-27
 Recomputing with Adjusted Angle 6-27
 Coordinate 6-28
 Determining Total Coordinate Corrections 6-28
 Determining Station Corrections 6-28
 Determining Adjusted Corrections 6-28
 Offset Legs 6-28
 Elevation 6-28
 Determining Elevation Correction 6-28
 Determining Adjusted Elevation 6-29
 Discretion Adjustment 6-29

Section VI. Locating Traverse Errors

Sources of Error 6-29
 Coordinate 6-29
 Elevation 6-29
 Azimuth 6-30
 Field Work 6-30
 Locating a Traverse Error 6-31
 Traverse Error Indicators 6-31
 Azimuth Good, Coordinates Good 6-31
 Azimuth Good, Coordinates Bust 6-31
 Azimuth Bust, Coordinates Good 6-31
 Azimuth Bust, Coordinates Bust 6-31
 Elevation Busts 6-31
 Isolation of Distance Errors 6-31
 Isolation of Angle Errors 6-32
 Perpendicular Bisector Method 6-33
 Mil Relation Formula (WeRM Rule) 6-33
 Analyzing Errors 6-34
 Isolation of Multiple Errors 6-34
 Isolation of Elevation Errors 6-34

Chapter 7. Astronomy

Section I. Basic Astronomy

The Tilted Polar Axis and Movement of the Earth 7-1
 Celestial Sphere 7-1
 Celestial Coordinates 7-2
 Astronomic Triangle (PZS Triangle) 7-3
 Polar Distance 7-4
 Coaltitude 7-4
 Colatitude 7-5
 Angles 7-6
 The Relationship between Solar Time and Sidereal Time 7-7
 Apparent Solar Time 7-8
 Mean Solar Time 7-8

Equation of Time 7-9
 Solar Year 7-9
 Concepts of Sidereal Time 7-9
 Time Zones 7-10
 Daylight Saving Time 7-11
 Converting Local Mean Time to Greenwich Mean Time 7-11
 Converting Greenwich Apparent Time to Greenwich Mean Time 7-12
 Determining the Local Hour Angle and Angle t 7-12
 Appendices 7-13

Section II. Artillery Astro Method

Arty Astro Method (Sun) 7-13
 Position of the Sun 7-13
 Time 7-14
 Solving the PZS Triangle 7-14
 Computations 7-15
 Arty Astro Method (Star) 7-15
 Position of the Stars 7-15
 Time 7-15
 Solving the PZS Triangle 7-15
 Azimuth Specifications 7-15
 Selecting Methods of Observation 7-15
 Observation and Tracking Procedures for Sun and Stars (Arty Astro) 7-15
 Stars 7-16
 The Sun 7-16
 Direct and Reverse Readings 7-16

Section III. Star Selection—Polaris

Orbit of Polaris 7-16
 Identifying Polaris 7-17

Section IV. Recording Astronomic Observations

Arty Astro Method Field Notes (Fifth Order) 7-18
 Heading and Column Titles 7-18
 Recording Field Data 7-19
 Arty Astro Method Field Notes (Fourth Order) 7-20
 Heading and Column Titles 7-20
 Recording Field Data 7-21

Chapter 8. Position and Azimuth Determining System Operations

Capabilities and Limitations 8-1
 Vehicles 8-1
 Accuracy: Zero-Velocity Corrections 8-1
 Primary and Secondary Pallets 8-2
 Inertial Measurement Unit 8-2
 Computer 8-3
 Control and Display Unit 8-3
 Power Supply 8-3

Control and Display Unit Operator Controls	8-4
Status Indicators	8-4
Operator Commands	8-5
DS Alerts	8-6
Power Supply Operator Controls	8-6
Computer Operator Controls	8-6
IMU Operator Controls	8-6
Recording PADS Field Notes	8-6
PADS Mission Procedures	8-8
30-Day Azimuth Gyro Bias	8-8
Initialization	8-8
Updating	8-9
Mark	8-9
PAE Codes	8-9

Chapter 9. Global Positioning System

Section I. Configuration, Signals, and Code

Satellite Signals	9-2
Carrier Frequencies	9-2
Data Sequences	9-2
Ephemeris and Almanac Data	9-4

Section II. System Safeguards, Error Sources, and Survivability

Selective Availability	9-4
Methods	9-5
Accuracy Levels	9-5
Antispoofing	9-5
Cryptovariables	9-5
Operational Key Material	9-5
Maintenance Key Material	9-6
Simulator Key Material	9-6
User Equipment Security	9-6
GPS Error Sources	9-6
Ephemeris Errors and Orbit Perturbations	9-6
Clock Error	9-6
Ionospheric Delays	9-7
Tropospheric Delays	9-7
Multipath	9-7
Receiver Noise	9-7
User Equivalent Range Error	9-8
Absolute GPS Accuracy	9-8
Root-Mean-Square Error Measures	9-9
Probable Error Measures	9-9
Dilution of Precision	9-10
Space Segment	9-10
Control Segment	9-11
User Segment	9-11
Cryptographic Key Security	9-11
Spoofing	9-11

Continuous Wave Jamming	9-12
Wide Band Jamming	9-12
Pulse and Amplitude Modulated Jamming	9-12
Jamming Effects on Code Acquisition.	9-12
Antijam Capabilities of GPS	9-13

Section III. GPS Measurements

GPS Reference System	9-13
Code Phase Measurements	9-13
Pseudo-random Noise Code.	9-14
Time Delay.	9-14
Satellite Ranging	9-15
Carrier Phase Measurements.	9-15
Integer Ambiguity	9-16
Carrier (Beat) Phase.	9-16
Continuous Carrier Phase.	9-16
Cycle Slips	9-16
Differencing	9-16
Single Differences	9-16
Double Differences between Satellites and Receivers.	9-17
Triple Differences between Satellites, Receivers, and Time	9-17
Baseline Solutions (Vectors).	9-18
Float Solution.	9-18
Fixed Solution	9-18

Section IV. GPS Survey Methods and Techniques

Absolute Positioning	9-19
Differential (Relative) Positioning	9-19
Code Phase Differential Positioning	9-19
Carrier Phase Differential Positioning.	9-20
Static and Kinematic Techniques	9-20

Chapter 10. Hasty Survey

Hasty Position Determination Method	10-1
MSGR 4000 (AN/PSN-13) Absolute.	10-1
PLGR (AN/PSN-11)	10-1
Map Spot	10-1
Hasty Azimuth Determination Method.	10-1
Hasty Elevation Determination Method	10-2
The M2A2 Aiming Circle.	10-2
M2A2 Body.	10-3
Telescope Assembly.	10-3
Body Assembly	10-3
Worm Housing.	10-4
Base Plate Assembly	10-4
Associated Equipment.	10-4
Setting Up the Tripod	10-5
Attach the Aiming Circle to the Tripod.	10-5
Plumb and Level the Aiming Circle.	10-5
Taking Down (March Ordering).	10-6

Measuring Horizontal and Vertical Angles	10-6
Determining Vertical Angle Correction.	10-6
Comparison Method	10-6
Alternate Set up Method	10-7
UTM Grid Declination Constant	10-7
When to Declinate an Aiming Circle (Required)	10-8
Declination Stations	10-8
Declinating the M2A2 Aiming Circle at a Declination Station	10-9
Converting a Grid Magnetic Angle to a Declination Constant	10-9
Hasty Declination.	10-10
Determining a Grid Azimuth	10-10
Orienting the M2A2 Aiming Circle on a Known Azimuth	10-10
Care of the Aiming Circle and its Associated Equipment	10-10
Maintenance Checks and Adjustments	10-11
Level Vial Check	10-11
Titled Reticle Check	10-11
Azimuth and Elevation Micrometer Knob Adjustment	10-11
Level Line Check	10-11
Magnetic Needle Check	10-11

Appendices

A	Star Cards	A-1
B	World Time Zone Offsets	B-1
C	Radio Transmitting Stations For Time Signals.	C-1
D	Conversions.	D-1
E	Glossary	E-1
F	References and Related Publications	F-1

Figures

1-1	Initial Control	1-3
1-2	Recovery of Existing Control	1-3
1-3	MC&G AAR Outline	1-5
1-4	Areas of Concern - Artillery Battalion	1-7
1-5	Distance Accuracy and Accuracy Ratio Standards.	1-11
1-6	Swinging the Grid.	1-14
1-7	Sliding the Grid.	1-16
1-8	Swinging and Sliding the Grid	1-17
3-1	Undulation.	3-1
3-2	Elevation	3-1
3-3	Ellipsoid	3-2
3-4	Defining Parameters	3-2
3-5	Local Reference Ellipsoid	3-3
3-6	ECEF Ellipsoid	3-3
3-7	Geoid Separation.	3-3
3-8	Ellipsoid Height	3-4
3-9	Relationship between h, H, and N.	3-4
3-10	Surface-Fixed Datum	3-5
3-11	Geocentric Datum	3-5

Figures (Continued)

3-12	Origin Shift Parameters	3-6
3-13	Coordinate Planes	3-7
3-14	Cartesian Coordinates	3-8
3-15	Geographic Coordinates	3-8
3-16	Parallels of Latitude	3-9
3-17	Meridians of Longitude	3-9
3-18	Graticule	3-9
3-19	Geodetic Coordinates	3-10
3-20	Astronomic Coordinates	3-11
3-21	Astronomic Longitudes of Prime Meridians	3-11
3-22	Deflection of the Vertical	3-12
4-1	Projection Types: Tangent and Secant	4-1
4-2	Mercator Projection	4-3
4-3	Mercator Projection Flattened onto a Plane	4-3
4-4	TM Projection	4-4
4-5	Distortion within the TM Projection	4-4
4-6	Secancy in a 6° Zone	4-5
4-7	Line Distortion and Scale Factor in the TM Projection	4-5
4-8	GK Projection	4-6
4-9	Line Distortion and Scale Factor in the GK Projection	4-6
4-10	Secant Condition of Lambert Conformal Conic Projection	4-7
4-11	Cone Flattened onto a Plane	4-7
4-12	Oklahoma Lambert Projection; North and South Zones	4-8
4-13	UTM/UPS Grid Zones and Grid Zone Designators	4-13
4-14	UTM Easting and Northing	4-14
4-15	UTM Grid Convergence	4-15
4-16	Sign of Grid Convergence	4-15
4-17	Nonstandard UTM Grid Zones	4-16
4-18	MGRS: 100,000-Meter Square Identification Lettering Convention for the UTM Grid, WGS 84/GRS 80 Ellipsoids	4-17
4-19	Specifications for Secondary Grids Listed in DMA TM 8358.1	4-20
4-20	Specifications for Secondary Grids not Listed in DMA TM 8358.1	4-21
5-1	T-2E Components	5-1
5-2	T-2E Components (Continued)	5-1
5-3	GDF22 Tribrach	5-1
5-4	T-2E Focusing Sleeve and Eyepiece	5-2
5-5	T-2E Reticle Pattern	5-2
5-6	First and Third Leveling Position	5-4
5-7	Second and Fourth Leveling Position	5-4
5-8	Pointings on a Range Pole	5-5
5-9	Pointings on a Target Plate (GZT1)	5-5
5-10	Pointings on a Target Reflector (GRZ3)	5-5
5-11	Pointings on an Eleven-Prism Holder (GPH11)	5-6
5-12	View of the T-2E Scales	5-6
5-13	Sample Circle Reading	5-7
5-14	Vertical Readings/Angles	5-9

Figures (Continued)

5-15	Optical Plumb Adjustment Screws	5-12
5-16	Computing the Corrected Reading	5-13
5-17	GEB-63 with Accessories	5-13
5-18	GEB-70 NiCad Battery	5-15
5-19	GEB-70 Discharge Rate	5-15
5-20	DI 3000 Bottom View	5-15
5-21	T-2E Modification for DI 3000	5-16
5-22	DI 3000 Mounted on T-2E	5-16
5-23	DI 3000 Control Panel	5-16
5-24	Prism-Target Distance	5-19
5-25	Adjusting Parallelism	5-20
5-26	Target Set with Target Plate	5-21
5-27	Target Set with GRZ3 and GPH3Z	5-21
6-1	Traverse	6-1
6-2	Open Traverse	6-1
6-3	Closed Traverse on a Second Known Point	6-2
6-4	Closed Traverse on the Starting Point	6-2
6-5	Starting and Closing Control	6-2
6-6	Rear, Occupied, and Forward Stations and Horizontal Angles	6-3
6-7	Vertical Angles	6-3
6-8	Reciprocal Vertical Angles	6-3
6-9	Slope and Horizontal Distances	6-4
6-10	Reduction to Sea Level	6-5
6-11	Traverse Legs	6-5
6-12	Standard Symbols for Recording	6-7
6-13	Index Page	6-7
6-14	Heading and Column Titles (One-Position Angle)	6-8
6-15	STA and T Columns	6-8
6-16	Standard Order for Recording a One-Position Angle	6-9
6-17	Example of a Completed One-Position Angle	6-9
6-18	Example of a Completed Two-Position Angle	6-10
6-19	Angle Closed on the Horizon	6-11
6-20	Example of an Angle Closed on the Horizon	6-11
6-21	Example of Recording with Reciprocal Vertical Angles	6-12
6-22	Heading and Column Titles (M2A2 Angles)	6-13
6-23	Example of Recorded Data for a Hasty Traverse	6-14
6-24	Heading and Column Titles (Intersection)	6-15
6-25	Example of Completed Intersection Method (M2A2)	6-15
6-26	Example of a Partial Void	6-16
6-27	Example of a Full-Page Void	6-17
6-28	Azimuth	6-18
6-29	Azimuth-Angle Relationship	6-19
6-30	Coordinate Triangle	6-19
6-31	Elevation Triangle	6-20
6-32	Value of Trigonometric Functions of Angles	6-20
6-33	Right Triangle	6-21
6-34	Determining the Sign of dE and dN	6-21

Figures (Continued)

6-35	Main Scheme Legs	6-22
6-36	Offset Legs	6-22
6-37	Traverse Closing Data Comparison	6-23
6-38	Radial Error of Closure	6-23
6-39	Pythagorean Theorem.	6-23
6-40	Elevation Error	6-24
6-41	Azimuth Error.	6-25
6-42	Azimuth Adjustment	6-27
6-43	Error Indicators.	6-31
6-44	Plotting the Traverse	6-32
6-45	Determining the Error Leg-Parallel Line Method	6-32
6-46	Plotting the Traverse	6-33
6-47	Determining the Error Station	6-33
6-48	Mil Relation Formula.	6-33
7-1	Earth's Rotational Axis	7-1
7-2	Celestial Sphere	7-2
7-3	Zenith Position	7-2
7-4	Ecliptic and Vernal Equinox	7-3
7-5	Right Ascension and Declination.	7-3
7-6	Vertices of the PZS Triangle	7-4
7-7	Polar Distance.	7-4
7-8	Coaltitude	7-4
7-9	Determining Coaltitude	7-4
7-10	Parallax.	7-5
7-11	Refraction.	7-5
7-12	Colatitude	7-5
7-13	Parallactic Angle	7-6
7-14	Hour Angle (Time Angle or Angle t).	7-6
7-15	Azimuth Angle	7-6
7-16	PZS Triangle.	7-7
7-17	Relationship between Solar Time and Sidereal Time	7-7
7-18	Concepts of Solar Time	7-8
7-19	Concepts of Sidereal Time	7-9
7-20	Time and Apparent Motion of the Sun.	7-10
7-21	Time Zone Boundaries.	7-10
7-22	Political Time Zones in the U.S.	7-11
7-23	Time Zone Letter Designations and Corrections: Local to Greenwich Mean Time	7-12
7-24	Solving the Arty Astro Method	7-13
7-25	Orbit of Polaris	7-17
7-26	Identifying Polaris	7-17
7-27	Relationship between the Observer's Latitude and the Vertical Angle to the Celestial North Pole	7-18
7-28	Heading and Column Titles (Fifth Order Arty Astro)	7-18
7-29	Remarks for Arty Astro	7-19

Figures (Continued)

7-30	Field Data (Fifth Order Arty Astro)	7-19
7-31	Heading and Column Titles (Fourth Order Arty Astro)	7-20
7-32	Field Data (Fourth Order Arty Astro First Set).	7-21
7-33	Field Data (Fourth Order Arty Astro).	7-21
8-1	Inertial Measurement Unit	8-2
8-2	Computer.	8-3
8-3	Control and Display Unit	8-3
8-4	Power Supply	8-3
8-5	Secondary Pallet (Battery Box).	8-4
8-6	Status Indicators	8-4
8-7	Porro Prism Components	8-6
8-8	The PADS Recording Procedures.	8-7
8-9	PADS Recording Procedures for Optical Azimuth Method.	8-8
8-10	PAE Codes	8-9
8-11	Example of PAE Readings	8-10
9-1	NAVSTAR System Configuration: Space, Control, and User Segments.	9-1
9-2	L1 Carrier Frequency	9-2
9-3	L2 Carrier Frequency	9-2
9-4	P Code and C/A Code Data Sequence	9-3
9-5	GPS Signal Data Flow	9-3
9-6	User Equivalent Range Error	9-8
9-7	Error Ellipse at 2- σ RMS	9-9
9-8	Pseudo-range.	9-14
9-9	Carrier Modulated by PRN	9-14
9-10	Time Delay of a GPS Signal.	9-14
9-11	Ranging One Satellite	9-15
9-12	Ranging Two Satellites.	9-15
9-13	Ranging Three Satellites	9-15
9-14	Single Differences between Receivers	9-17
9-15	Single Differences between Satellites.	9-17
9-16	Double Differencing	9-17
9-17	Triple Differencing	9-17
10-1	Aiming Circle M2A2	10-2
10-2	M2A2 Accessory Kit	10-4
10-3	Angular Value Representing UTM Grid Declination.	10-8
10-4	Relationship between a GM Angle and a Declination Constant.	10-9

Tables

4-1	TM Projection Scale Factor by UTM Easting	4-5
4-2	Projection Features	4-9
5-1	Typical Ranges	5-14

CHAPTER 1. FUNDAMENTALS

SECTION I. MISSION AND DUTIES

The mission of the Marine artillery surveyor is to provide a common grid. This means that all fire support and targeting assets are oriented the same with respect to *azimuth, position, and elevation* to a prescribed accuracy. A common grid is based on the sum of the components of relative survey (the geodetic system, the coordinate system, and the map projection/grid system) of the operational area. See chapters 3 and 4 for detailed descriptions of these components.

Establishing a common grid is a command responsibility. A common grid does not apply to artillery only. It must be established throughout the battlespace and constantly maintained for use by all fire support assets. To provide a common grid is to provide data to the required accuracy that permits—

- Massing of fires; i.e., bringing more than one firing unit to bear against a common target at the same time without prior adjustment or registration of separate artillery units.
- Delivery of surprised observed fires; i.e., accurate and timely fires against enemy positions with no adjustment. If fires must be adjusted, the element of surprise is lost.
- Delivery of effective unobserved fires; i.e., effective and timely fires against enemy positions that are not observed (group and series targets or prep fires). Without survey, unobserved fires can only be effective if the target had been previously fired on.
- Transmission of target data from one unit to another; i.e., the ability of one firing unit to provide locations of adjusted targets to another firing unit for subsequent engagement by that unit or for massing fires.
- A firing unit to carry a registration forward to a new position. This is necessary when moving a battery from one primary position to another and when moving to an alternate or supplementary position. A common grid is also required between a firing position and an offset registration point.

All stations surveyed in the same network are relative to specific points regardless of the survey methods used (those points being the known control used to fix and adjust those networks). Stations surveyed from other points that have already been listed as common are relative to those stations within that unit's specified level of accuracy. For example, if a battalion survey section establishes a battery position (orienting station [OS] and end of orienting line [EOL]) from fourth order or higher common control, the battery position is common to the higher order control but at a fifth order accuracy.

All stations surveyed from a point whose location was obtained by hasty methods (map spot or hasty resection) or from absolute methods (military survey grade receiver [MSGR] 4000, precision, lightweight, GPS, receiver [PLGR]) are common to that point. However, they are not common to any local control. Stations not already common to another network can be made common by adjustment or by conversion to common control calculations.

For two stations to be considered common, they must meet the requirements of the previous paragraphs. They must be referenced to the same datum/ellipsoid and developed from the same map projection. The grid system or the coordinate system must be the same between the points. They must be from the same network or have been adjusted or converted to the same network.

Survey Operation Steps

Planning

Survey planning begins with understanding the maneuver commander's intent and receiving the fire support coordinator's guidance. During planning, full consideration is given to the commander's concept of operations, priorities, the tactical situation, etc.

Aggressive survey planning that answers the questions who, what, where, when, why, and how is essential to mission success. See chapter 2.

Coordination

Coordination is conducted at or through the combat operations center (COC). The survey information center (SIC) is the liaison with the topographic surveyors and non-artillery units requiring survey control. The coordination and planning effort at the COC is conducted by the highest echelon artillery survey officer in the area of operations. The survey plan is further coordinated with the next lower echelon survey officer and any survey officers with higher or adjacent commands as needed.

Field Work

Survey field work is performed by the survey section using the methods and equipment to extend common survey throughout the command's area of responsibility as directed by the survey plan. Field work must be started immediately upon receipt of the survey order and be continuously and aggressively pursued until the survey plan is completed.

Computations

Survey computations and field work are performed simultaneously. Computations are the use and calculations of all data needed to convert the field work to usable azimuths, positions, and elevations. This includes computations of conventional surveys, updating and adjusting position and azimuth data, calibrating kinematic global positioning systems (GPS) data, and adjusting static GPS data.

Echelons of Survey

Three echelons of artillery survey exist: regiment, battalion, and battery as well as three accuracy levels: fourth, fifth, and hasty. The survey section's mission at each echelon determines what level of accuracy is required.

Regiment Survey Section

The primary mission of regiment surveyors is to provide a common grid over the division area. This includes establishing initial control, recovery of existing control, and conversion to common control over stations not in the division network. The artillery regiment's survey section is the division's survey asset. The regiment survey section—

- Normally performs fourth order surveys. In some cases, they will be required to establish fifth order survey control for units not already covered by a battalion survey section or for units attached to the regiment.
- Establishes permanent survey control markers when necessary.
- Establishes and maintains an SIC to provide required data to lower echelon survey sections to conduct their survey missions.

Establishing Initial Control

Usually, the tactical situation on initial entry of forces into an area will make the recovery of existing control impossible. However, survey operations must begin immediately at all levels. Establishing an initial common grid throughout the division area is of the utmost priority for surveyors. See figure 1-1.

Initial control is the first station or network of stations established in theater. Establishing initial control can be done by hasty means such as absolute GPS survey or by map spot. Initial control can also be established as a network by static GPS methods, kinematic GPS methods or position and azimuth determining system (PADS). In each case, a single absolute or map spot station is the controlling grid and usually only includes the battalion's position areas.

Recovering Existing Control

The initial control will suffice to start an operation. But continuing that operation will require recovering existing control into the target and connection areas of the battalions and conversion of recovered control to the common grid throughout the entire division area. See figure 1-2.

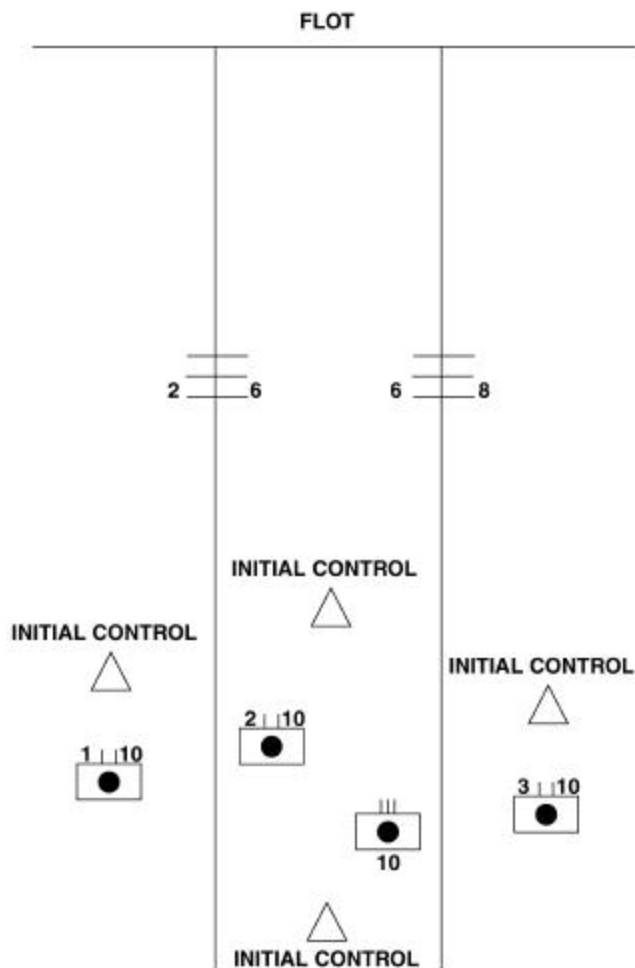

Figure 1-1. Initial Control.

This effort must continue throughout the operation using the most accurate methods available. Static GPS methods are preferred as their accuracy allows for establishing accurate calibration stations for kinematic GPS networks at regiment and battalion levels. These stations can also be used to position new base stations and update PADS for forward movement of the common network.

When necessary, survey teams can employ PADS and conventional assets in the recovery effort. Control that existed in the areas formally held by enemy forces should be included in the recovery effort as the battle progresses. Data from captured enemy trigonometry (trig) lists can be converted to common control for inclusion in the division

network. The recovery effort is coordinated by the regiment survey section and will usually be conducted by available surveyors from all echelons.

Priorities of Survey

Priorities of survey will be established in the operation order. Normally, priorities will be focused at the establishment of common survey within the position areas of the artillery battalions. Second priority will generally be focused at the target areas of the battalions. In some cases, target acquisition assets not attached to a battalion will receive the highest priority for survey. Ultimately the priority is situation-dependent and cannot be standardized.

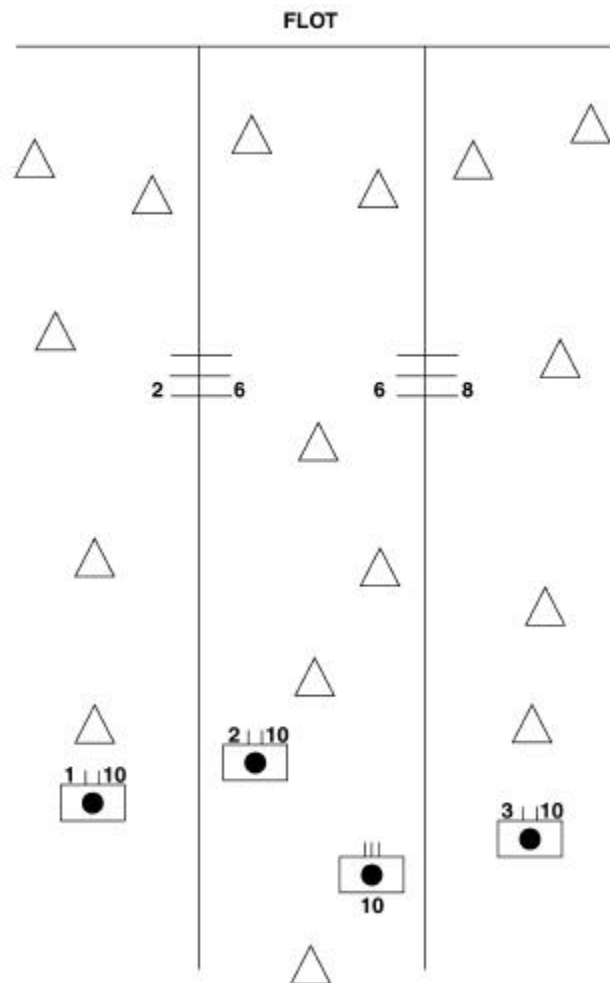

Figure 1-2. Recovery of Existing Control.

Survey Information Center

The SIC collects, evaluates, maintains, and disseminates survey information. It is the centralized planning and coordination element for all survey operations. It consists of the regiment survey officer, the survey chief, and assigned personnel. Although the SIC is not reflected in the table of organization (T/O), its duties are important to establish and maintain the common grid. The SIC is responsible for collecting the most up-to-date information available from some of the following agencies:

- National Imagery and Mapping Agency (NIMA).
- National Oceanic and Atmospheric Administration (NOAA).
- National Ocean Survey (NOS).
- National Geodetic Survey (NGS).
- United States Geological Survey (USGS).
- Bureau of Land Management (BLM).
- U.S. Forestry Department.
- U.S. Army Corps of Engineers (COE).
- Department of Transportation (DOT).
- State Geodetic Survey.
- Local: County/City surveyors.
- Base/Post Public Works Department.
- U.S. State Department/Embassies.
- U.S. Naval Oceanographic Office.
- U.S. Army Topographic/Survey Units.
- U.S. Marine Corps Topographic Units.
- MAGTF operation and intelligence sections.

Collected information consists of more than just survey data. It is important that the SIC maintains information such as time zone charts, country handbooks, training area information, and any other information that may help accomplish the mission. A limited number of mapping products should be kept on hand for planning, briefing, and verifying survey control.

Mapping, Charting, and Geodesy After Action Report

For SICs to provide the most current survey information data available, a mapping, charting and

geodesy after action report (MC&G AAR) should be expeditiously submitted by returning deployed units. The SIC uses this report to identify areas of operation used by MAGTFs and to provide information about the area of operation, map products required, and availability of survey control. Figure 1-3 shows the outline to generate a thorough MC&G AAR about the area of operation.

Evaluation

The regiment's survey section also evaluates surveys conducted by lower echelon survey sections. All computations and values recorded in the recorders notebook (see chap. 6) are checked for proper procedures, specifications, and techniques to complete survey field work to the required accuracy.

Computations performed by computers are compared to see that both sets of computations agree. Check to ensure that the survey has been properly closed to within the specified accuracy. If the surveyed data passes the procedure check, computation check, and closure check, data is plotted on the largest scale map available to check the validity of the survey and the accuracy of the map. If the map plots verify the recorder's field notebook description, the survey is accepted.

SIC personnel are equipped and trained to also make the following checks and computations:

- Swinging and sliding operation to convert survey data from one grid to another.
- Transformation of coordinates and grid azimuths between universal transverse mercator (UTM) zones.
- Conversion of geographic coordinates to grid coordinates and grid coordinates to geographic coordinates.
- Datum-to-datum transformation.

Maintenance

The SIC must maintain the information it has collected in a usable form. A survey information map with overlays and a survey information file allow information to be used.

- Unit
- Exercise/Operation Name
- Date of Operation
- Country
- Training Area
- Nearest City/Town
- Area of Operation Coverage
 - By Geographic Coordinates
 - Minimum Latitude
 - Maximum Latitude
 - Minimum Longitude
 - Maximum Longitude
 - By Military Grid Reference System
 - NE Corner
 - SE Corner
 - SW Corner
 - NW Corner
- Map Coverage
 - Map Series
 - Map Sheet Number(s)
 - Ellipsoid on Map Product
 - Datum on Map Product
 - Grid on Map Product
 - Grid Zone Used
 - What Agency Produced the Map Product
- Grids to Firing Positions (six-place grid)
- Grids to Observation Posts (best available grid)
- Grids to Identify Impact Area or Safety Box
- Target Grids (six-place grid)
- Amphibious Landing Beach Grids (left and right limits or center and length)
- Route of March Used During the Operation (identify problems unique to artillery: bridge, culvert, tunnel fords, road restrictions or other problems)
- Restricted Areas
- Points of Contact for Range Information (include name, address, and telephone number)
- Points of Contact for Survey Information (include name, address, and telephone number)
- Trig List Information (if data was provided before deployment, list problems, lack of data, lost or destroyed control points, accessibility of control, any information on geodetic control)
- Survey Control Recovery/Survey Information (copies of recovery notes, new survey control point information, trig lists)
- Grid Convergence and/or Datum Transformation (if needed, what method was used?)
- General Comments (artillery-oriented or other)
- Point of Contact at Unit

Figure 1-3. MC&G AAR Outline.

The map shows all survey control in the area of operation. Map overlays show the locations of artillery units, possible position areas, and other information required by unit standard operating procedure (SOP). Maps and overlays should also show—

- Survey control points.
- Completed surveys.
- Proposed surveys.
- The friendly situation and the enemy situation when it might affect the planning or performance of survey operations in the division area.

The information file should contain all information available through all resources. A record is maintained of field notes and computations on control points.

The SIC must ensure that known control points are entered into a computerized data base. All survey control points (SCPs) in the division area of interest and in the supported unit areas of influence should be entered and updated. The SCP data base must be kept current to decrease the possibility of duplicate surveys and to rapidly exchange survey data automatically.

The survey information sheet permits quick identification of SCP data. This form must contain the following information:

- Control point name and number.
- Map sheet and series number.
- UTM grid and geographic coordinates.
- Elevation.
- UTM grid zone.
- Marking method.
- Accuracy of the data.
- Description.
- Sketch.
- Methods used in determining control.
- Verification information (unit, preparer, and date).

Dissemination

Timely dissemination of survey information is just as important as maintaining a complete and accurate survey information file. Survey information is disseminated by command and control systems, radio,

telephone, personal visits, and field liaison among survey sections.

Survey data can be stored and rapidly transmitted by using digital command and control systems. Unit SOP will dictate the procedures to access, store, update and disseminate survey information between echelons. A digital net and a voice net may be allocated to the SIC.

Security requirements outlined in the unit communications electronic operation instructions (CEOI) must be observed. Radio or telephone communication is the least desirable method of disseminating survey information. Possible errors in transmitting and problems in orally describing the survey station sketches may occur.

This exchange of survey information works from higher to lower echelons and vice versa. Often the battalion surveyor has not only conducted surveys requiring him to provide data to regiment levels, but he has a fresh insight as to the happenings in the battlespace. This information must also be disseminated to all concerned. Seemingly innocuous information may have far reaching implications when applied to a larger picture.

Battalion Survey Section

The primary mission of battalion surveyors is to provide a common grid over the artillery battalion's area of operations. This includes providing control to all units, organic or attached to the battalion. The battalion survey section may be tasked to provide control to units requiring survey who are not attached to the battalion but who are operating within the battalion's area. Due to their wide ranging and independent operating nature, the battalion survey section also acts as the artillery battalion's reconnaissance element.

The battalion survey section will normally perform fifth order surveys. When a battalion is operating independently from the artillery regiment, as with a Marine expeditionary brigade (MEB), they may be required to establish some limited fourth order control. Normally the battalion survey mission requires a more timely response than is afforded with fourth order

work. If a regiment's survey section is included in a follow-on force, all fourth order work performed by the battalion must be provided to the regiment section for inclusion in their network.

Areas of Concern

The artillery battalion operational zone is divided into three areas of concern: the position area, target area, and connection area. This delineation is necessary to plan survey operations and to aid in prioritizing installations. See figure 1-4.

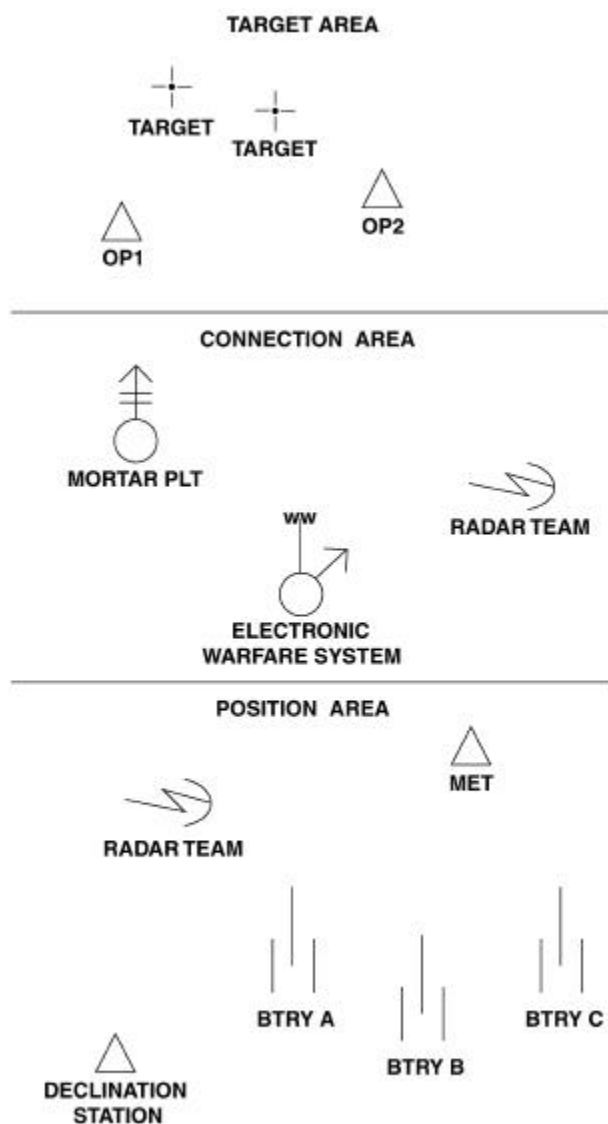

Figure 1-4. Areas of Concern - Artillery Battalion.

The position area is the rear most area of the artillery battalion's zone. Installations here are usually afforded the highest priority. The position area includes the artillery firing positions (alternate, supplementary, and offset registration positions), declination stations, and possible meteorological and radar sites. Other sites may be included to complete the mission.

The target area is the forward area of the artillery battalion's zone. Installations in this area are usually prioritized behind position area installations. The target area includes observation posts, targets, and other target acquisition assets.

The connection area is the portion of the artillery battalion's zone that lies between the position area and the target area. It is called the connection area because its main function is to connect the target and position areas into a common network. Installations requiring survey support that lie in this area are included in the connection area surveys. These installations may include radar and meteorological sites, electronic warfare sites, mortar positions, and other sites to complete the mission.

The battalion survey section will not establish permanent survey control unless it is essential to the mission.

Categories of Starting Control

A battalion survey section must begin survey operations immediately. The availability of survey control, which depends largely on the tactical situation, terrain, and weather, may be scarce. Although there are several ways of obtaining starting control, the survey section uses the best available control to begin a survey. Variations in starting control can be grouped into four different categories:

- Known coordinates, elevation, and azimuth.
- Assumed coordinates and elevation, known azimuth.
- Known coordinates and elevation, assumed azimuth.
- Assumed coordinates, elevation, and azimuth.

Known coordinates and elevation will be obtained from higher echelon survey sections; i.e., SIC normally from a trig list. When known coordinates and elevations are unavailable, they must be assumed through hasty survey methods.

Known azimuths can be obtained from several different sources. Normally, a known azimuth will be computed from higher echelon coordinates or published in a trig list. When celestial bodies are visible, an azimuth from astronomic observation is preferred. When known azimuths are unavailable, they must be assumed through hasty survey methods.

Marking and Witnessing Stations

This important procedure allows for ease of site location and identification. Mark positions with a wooden hub and tag. Stations will be witnessed by a wooden stake and tagged.

The OS of any position is marked and witnessed by a stake painted yellow, and set in the ground at an angle pointing towards the EOL.

The EOL of any position is marked and witnessed by a stake painted red, and set in the ground at an angle pointing towards the OS.

Information written on a tag is usually subject to SOP. The position number is the only information that must be listed on the tag. Make sure that valuable information is not left on a tag that the enemy may use if discovered; e.g., grid coordinates or unit name.

Dissemination of Survey Data

Once required surveys are completed, the accumulated data is provided to the battalion S-3 for dissemination to firing units and fire support assets. Data is also forwarded to the regiment SIC. A current list of positions is generated, and on arrival at a position, this list is referred to for the pertinent data. Position number blocks may be assigned by SOP to the battalion survey sections to alleviate confusion and expedite dissemination of data.

Battery Survey Section

The primary mission of battery surveyors is to provide survey control inside the battery position when higher echelon survey is not already available or to carry control from one battery position to another. This

second position could be used as an alternate/supplemental position or for split battery operations. Battery surveyors will only perform hasty surveys. Higher echelon surveyors must upgrade these surveys when mission requirements permit.

Collective Duties

Assigning positions within the survey section should be administrative. Versatility and adaptability are the keys. All section members must be familiar with and able to perform all current survey methods regardless of their billet. Marines must understand the advantages and disadvantages of all current survey methods. Thorough knowledge, individual initiative, and a belief that some form of survey is always possible must be the tenets of a successful survey section. The following duties pertain to regiment and battalion survey sections collectively.

Survey Officer

The survey officer fights the future battle, continually planning for the next phase of an operation. He must maintain situational awareness of the battle through close liaison with the intelligence officer (S-2) and the operations officer (S-3) and by coordinating the current survey effort with the survey chief. Duties follow:

- Advise the commander of the capabilities and limitations of the survey section.
- Provide input to the commander on datum and ellipsoid selection and options.
- Recommend SOPs to the commander.
- Coordinate, supervise, and inspect the training of survey personnel; preventive maintenance program for survey equipment; communications assets, and vehicles; and SIC if authorized at his echelon.
- Formulate the survey plan after receiving orders from the S-3.
- Issue survey orders and brief the survey chief and team chiefs.
- Conduct reconnaissance.

- Coordinate survey operations with survey officers of higher, lower, and adjacent commands.
- Advise and assist firing units and target acquisition sections in training for and conduct of hasty survey operations.

Survey Chief

The survey chief fights the current battle by implementing the survey officer's plan. He acts as the direct link between the survey officer and the teams in the field. He keeps the survey officer apprised of the current situation and handles any immediate problems. Duties follow:

- Assist the survey officer.
- Perform the duties of the survey officer in his absence.
- Train the survey section in the performance of reconnaissance, communications, maintenance, and survey operations.
- Act as the section's logistician.
- Maintain liaison with the survey officer.
- Perform other duties as directed.

Conventional Team (Party) Chief

- Train his survey party.
- Inform/brief his party on the survey plan.
- Execute his portion of the survey plan.
- Supervise and coordinate field operations of his survey team.
- Maintain liaison with the survey officer/chief.
- Supervise and inspect preventive maintenance of section equipment, including vehicles, communications equipment, weapons, and survey equipment.
- Perform other duties as directed.

Survey Computer

- Maintain the current forms for survey computations.
- Perform independent computations during field operations with the current survey computer system.
- Maintain the section's survey computer systems including all accessories (printers, batteries, etc.).
- Perform other duties as directed.

Instrument Operator

- Perform preventive maintenance on the team's survey instruments to include operator's adjustments.
- Operate the instruments during field operations.
- Read measured values to the recorder and verify the recorded data when read back.
- Familiarize himself with the field work requirements for all survey methods.
- Perform other duties as directed.

Recorder/Computer

- Perform the duties of the team chief in his absence.
- Maintain the field recorder's notebook for all surveys performed by his team.
- Neatly and legibly record measurements and survey data in accordance with this text and local SOP.
- Check and mean measurements determined by the instrument operator.
- Provide required field data to the computers. Familiarize himself with the field work requirements for all survey methods.
- Perform other duties as required.

PADS Operator (PADS Team Chief)

- Execute his portion of the survey plan.
- Maintain liaison with the survey officer/chief during field operations.
- Supervise and inspect preventive maintenance of section equipment, to include vehicles, communications equipment, weapons, and survey equipment.
- Operate and maintains the PADS.
- Monitor the PADS control and display unit (CDU), fault indicators, and status indicators during operation.
- Set up and operate the T-2E theodolite during autoreflexion operations.
- Brief the assistant PADS operator on the survey mission and requirements.
- Perform other duties as directed.

Assistant PADS Operator

- Operate and maintain the PADS vehicle.
- Install, operate, and maintain the communications equipment.
- Maneuver vehicle for autoreflexion or plumb bob positioning over an SCP or points to be established under the direction of the PADS operator.
- Record PADS data and maintain the field recorder's notebook.
- Set up range poles and establish survey stations as directed by the PADS operator.
- Perform the duties of the PADS operator in his absence.
- Perform other duties as directed.

SECTION II. SURVEY ACCURACY LEVELS AND REQUIREMENTS

Figure 1-5 shows survey accuracy levels as designated by the NGS and the NIMA as well as the three artillery levels.

Geodetic Control Surveys

Geodetic control surveys are high order surveys established for the purposes of mapping, engineering, and other projects requiring extreme accuracy. Classifications and standards for this type of survey are issued by the Federal Geodetic Control Subcommittee (FGCS). FGCS classification and specifications for relative GPS surveys are listed in FGCS manual *Geometric Geodetic Accuracy Standards and Specifications for Using GPS Relative Positioning Techniques*. FGCS classification and specifications for conventional surveys are listed in FGCS manual *Standards and Specifications for Geodetic Control Networks*.

Artillery Survey

Relative Position Accuracy

A relative accuracy value (accuracy ratio {AR}) can be determined to show the position accuracy for a survey network. AR is the ratio between the position error and the total length of a survey. It shows the survey length necessary to allow for 1 meter of position error in a given survey and is expressed as a fraction with 1 as the numerator, and the survey length producing that error as the denominator. Required ARs for artillery surveys are fourth order (considered accurate to 1-meter error for every 3,000 meters surveyed [1/3,000]) and fifth order (considered accurate to 1-meter error for every 1,000 meters surveyed [1/1,000]). Hasty survey is considered accurate to 1-meter error for every 500 meters surveyed.

Category	Order	PPM	AR
GPS: Global-regional geodynamics; deformation measurements	AA	0.01	1:100,000,000
GPS: NGRS, "primary" networks; regional-local geodynamics; deformation measurement	A	0.1	1:10,000,000
GPS: NGRS, "secondary" networks; connections to the "primary" network; local geodynamics; deformation measurements; high precision engineering surveys	B	1	1:1,000,000
GPS: NGRS (terrestrial-based), dependant surveys to mapping, land information, property, and engineering requirements	(C)		
	Class 1	10	1:100,000
	Class 2-I	20	1:50,000
	Class 2-II	50	1:20,000
Conventional	Class 3	100	1:10,000
	1st	10	1:100,000
Conventional	2nd, Class I	20	1:50,000
Conventional	2nd, Class II	50	1:20,000
Conventional	3rd, Class I	100	1:10,000
Conventional	3rd, Class II	200	1:5,000
Conventional, Artillery	4th	333	1:3,000
Conventional, Artillery	5th	1,000	1:1,000
Conventional, Artillery	HASTY	2,000	1:500
GPS accuracy standards represent at 95% confidence level.			
1st, 2nd, and 3rd order conventional standards represent the ratio 1:A, when A (distance accuracy) equals the distance between survey points divided by the propagated standard deviation between points.			
4th, 5th, and Hasty order conventional standards represent the ratio 1:A, when A (accuracy ratio) equals the total traverse length divided by the radial error of closure.			

Figure 1-5. Distance Accuracy and Accuracy Ratio Standards.

Probable Error Values

For some systems or survey methods; e.g., the PADS or GPS; probable error (PE) values describe the accuracy. These values generally express absolute accuracy. However, depending on the system and the survey method, they can describe a relative accuracy. These values may be given in terms of circular error probable (CEP), PE or various standard deviation values; e.g., 2 DRMS or 3 sigma. These values are expressed in terms of a percentage of probability or confidence that the position given is located within a line, circle or sphere of a given size.

PE is a value which is exceeded as often as it is not, i.e., it has a 50% probability of occurrence. With respect to fixation (position), the PE applies to both East/West and North/South axes.

CEP is a radius of a circle, centered about the true position such as that any measured or calculated position has a 50% probability of lying within that circle.

PE and CEP are derived from the positive standard deviation of the measurement as (sigma σ):

$$PE = 0.6745.$$

$$CEP = 1.1774.$$

$$CEP = 1.7456 PE.$$

Relative Azimuth Accuracy (Fourth Order)

Fourth order astronomic azimuths are established by astronomic observations, the PE of which does not exceed 0.060 mils. The considered accuracy is 0.150 mils.

An azimuth of a line in a fourth order survey that, from its point of origin at a fourth order astronomic azimuth or higher order direction, has depreciated in accuracy by a PE value of 0.030 mils per main scheme angle (using a T-2E); or the azimuth of a line computed between two fourth order or higher survey control points is considered accurate to fourth order standards. The computed azimuth is considered accurate to 0.300 mils.

Relative Azimuth Accuracy (Fifth Order)

Fifth order astronomic azimuths are established by astronomic observations, the PE of which does not exceed 0.120 mils. The considered accuracy is 0.300 mils.

The azimuth of a line in a fifth order survey that, from its point of origin at a fifth order astronomic azimuth or higher order direction, has depreciated in accuracy by a PE value of 0.030 mils per main scheme angle (using a T-2E); or the azimuth of a line computed between two fourth order or higher survey control points is considered accurate to fifth order standards. A fifth order azimuth cannot be obtained by computations between a fifth order point and a point of equal or higher order.

Required Survey Formats

The format of the survey data provided depends on the type of position being surveyed.

An artillery firing position requires establishing an OS and the EOL. The orienting line must be one of the main scheme legs of the survey when conducting a traverse. Both ends of the orienting line must be occupied. The required survey data for an artillery firing position is the operational datum and ellipsoid, UTM easting and northing of the OS, elevation (meters) of the OS, and the UTM grid azimuth (mils) from the OS to the EOL.

The survey requirement for the multiple launch rocket system (MLRS) is the operational datum and ellipsoid, UTM easting and northing of initialization and update points, as well as the elevation (meters) of those points.

An artillery radar position requires establishing an OS and the EOL. The required survey data for an artillery radar position is the operational datum and ellipsoid, UTM easting and northing of the OS, elevation (meters) of the OS, UTM grid azimuth (mils) from the OS to the EOL, distance (meters) from OS to EOL, and vertical angle (mils) from OS to EOL.

For radio directional finder (RDF) operations, a meteorological measuring system (MMS) position requires establishing an OS and the EOL. For Loran or

very low frequency (VLF)/Omega operations, only the OS is required. The required survey data for an MMS position is the operational datum and ellipsoid, latitude and longitude (decimal degrees expressed to 0.01°) of the OS, elevation (meters) of the OS, true azimuth in decimal degrees expressed to 0.1° from the OS to the EOL.

A remotely piloted vehicle/unmanned aerial vehicle (RPV/UAV) position requires establishing a tracking control unit (TCU) and a beacon. The required survey data for an RPV/UAV position is the operational datum and ellipsoid, UTM easting and northing of the TCU, elevation (meters) of the TCU, and the UTM grid azimuth (mils) from the TCU to the beacon.

The requirement for a declination station is the operational datum and ellipsoid, UTM easting and northing (accurate for map spot) and a UTM grid azimuth (expressed to 0.1 mils) to at least two azimuth marks in different quadrants. The true azimuth in decimal degrees expressed to 0.01° should be provided for declination of the met theodolite.

The requirement for an observation post is the operational datum and ellipsoid, UTM easting and northing, the elevation (meters), and a UTM grid azimuth (mils) to an azimuth mark, preferably an intervisible observation post (OP).

The requirement for a registration point (RP) is the operational datum and ellipsoid, UTM easting and northing expressed to the nearest meter, elevation expressed to the nearest meter, and the UTM grid azimuth expressed to the nearest mil. The azimuth should be from the OP designated as O1 for the target survey. However, the tactical situation may deem it necessary to perform the registration from an OP other than O1. Ideally, the RP should fall within the 800 mil-fan of the registering battery's azimuth of fire.

The survey requirement for targets other than registration points is the operational datum and ellipsoid, UTM easting and northing expressed to 10 meters and elevation expressed to 10 meters.

SECTION III. CONVERTING TO COMMON CONTROL

The highest echelon survey unit in the area establishes the common grid. Missions of lower echelon units require they initiate survey operations immediately without waiting for control to be established by higher echelon units. A firing battery must use hasty methods to establish survey so that it can provide support immediately. It cannot wait on control from the battalion survey section. Battalion surveyors must provide control to the firing batteries and target acquisition assets assigned to that battalion. They cannot wait on regiment surveyors to provide control. Regiment surveyors must establish control immediately throughout the division area without waiting for topographic surveyors or recovery of existing control currently in enemy territory. These initial surveys are not considered to be on a common grid so conversion to a common grid will be required.

Comparisons: Why We Convert

Conversion to common control is performed by making a comparison between the higher and lower

echelon data and converting the lower echelon to the higher echelon based on that comparison. Data is converted to common control when higher and lower echelon data differ by—

- 2 mils or more in azimuth.
- 10 meters or more in radial error.
- 2 meters or more in elevation.

Azimuth

When a comparison is made between the azimuths of a line that is included in the higher and the lower echelon network, the lower echelon network must be converted to common control if the azimuths differ by 2 or more mils. For example, a firing battery uses the hasty astro method and determines an azimuth from the OS to the EOL of 2319.0 mils. The battalion real time kinematic/on the fly (RTK/OTF) team arrives and determines an azimuth of 2321.6 mils over the same line. The difference between the higher and lower data is 2.6 mils. The azimuth must be converted.

Radial Error

When a comparison is made between the coordinates of a point that is included in the higher and lower echelon networks, the lower echelon network must be converted to common control when the radial error (RE) between the stations is 10 meters or more. RE in this case is not the RE computed for a traverse closure. It is the straight-line distance between the higher and lower echelon coordinates of the same station.

Elevation

When a comparison is made between the elevations of a point that is included in the higher and lower echelon networks, the lower echelon network must be converted to common control when the difference between the elevations is 2 meters or more. For example, a firing battery uses hasty survey methods to determine an OS elevation of 432 meters; the battalion survey team uses RTK/OTF methods to determine an OS elevation of 437.4 meters. The difference between the two elevations is 5.4 meters. The lower echelon data must be converted to common control.

Several methods of converting data to a common network are available. The method used depends on the type and amount of azimuth, coordinate, and/or elevation error between the higher and lower echelon data. The rest of this section discusses methods to convert data.

Swinging the Grid

Swinging the grid converts a lower echelon network to the higher echelon network when the azimuth difference is 2 mils or greater and the RE is less than 10 meters. This is usually necessary when an azimuth is assumed in conventional survey methods. For azimuth from PADS, differential GPS methods or by astronomic methods, the azimuths between higher and lower echelons will usually be within the 2-mil specification. See figure 1-6.

Recomputing the Survey

As long as a survey is maintained in the memory of a survey computer program, the easiest way to convert a

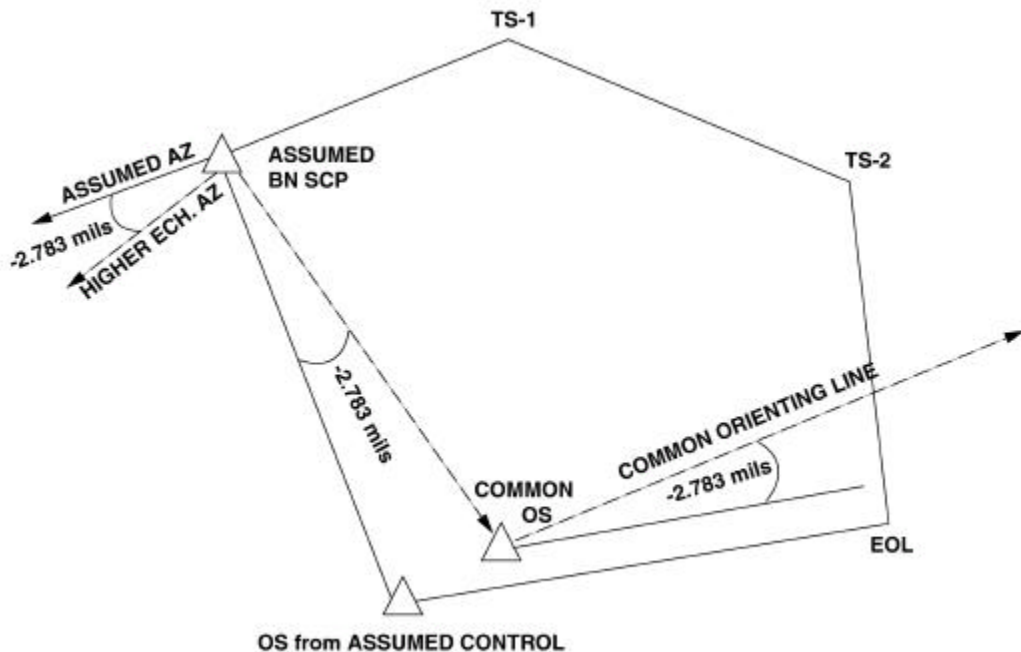

Figure 1-6. Swinging the Grid.

lower echelon network to the higher echelon grid is to enter the higher echelon data in the survey computer and recompute the survey.

Computing Individual Legs

Sometimes it is not necessary to recompute the entire traverse. For example, if a traverse has 20 legs and only 4 of those legs are between critical stations, it may be faster to compute individual legs. When swinging the grid over individual legs, perform Steps 1 through 4.

Step 1. Determine the azimuth correction by subtracting the lower echelon azimuth from the higher echelon azimuth. For example, the azimuth assumed by a battalion survey section is 4390 mils, the azimuth over that leg as determined by the higher echelon section is 4387.217 mils. Determine the correction as—

Higher	4387.217
Lower	4390.000
Correction	<u>-2.783</u> mils

Step 2. Compute the azimuth and distance between the starting station and each critical station using the coordinates determined in the lower echelon survey.

Step 3. Determine the adjusted azimuth to each critical station by applying the azimuth correction determined in Step 1 to each azimuth determined in Step 2. For example, if the azimuth computed in Step 2 from the starting station to the OS is 2745.354 mils, determine the adjusted azimuth as—

Computed	2745.354
Correction	-2.783
Adjusted Azimuth	<u>2742.571</u> mils

Step 4. Using the adjusted azimuth from Step 3 and the computed distance from Step 2, compute a dogleg (offset) coordinate for each station. This step places the critical station on common grid.

Determining the Common Azimuth of a Critical Line

Apply the azimuth correction from Step 1 to the azimuth determined in the original computations. This places the azimuth line on a common grid. For

example, if the azimuth from the OS to the EOL in the original computations was 1537.876 mils, determine the adjusted (common) azimuth as—

Computed	1537.876
Correction	-2.783
Common Adjusted Azimuth	<u>1535.093</u> mils

Sliding the Grid

This method converts a lower echelon network to the higher echelon network when the azimuth difference is less than 2 mils, and the RE is 10 meters or greater. This is usually necessary when a position is assumed. Sliding the grid converts to common control with the PADS and differential GPS operations. See figure 1-7 on page 1-16.

When using differential GPS survey methods, the conversion to common control is performed in the software. Conversion to common control is performed by calibrating the kinematic network for RTK/OTF operations. Conversion to common control is performed by changing the fixed position of the assumed station in the TrimNet software for a static GPS network.

For PADS operations, there is no way to convert stored stations to common control internally to the PADS. Converting individual stations is performed as shown in Steps 1 and 2.

Step 1. Determine the easting and northing correction between the lower and higher echelon data by subtracting the lower echelon easting and northing from the higher echelon easting and northing. For example, a battalion survey section updates its PADS with a PLGR grid of E: 555267 N: 3835216. A regiment survey team later provides common control over that station using differential GPS methods and determines a grid of E: 555278.32 N: 3835211.87. Determine the correction as—

	Easting	Northing
Higher	555278.32	3835211.87
- Lower	555267.00	3835216.00
Correction	<u>+11.32</u>	<u>-4.13</u>
	meters	meters
	(+11.3 meters)	(-4.1 meters)

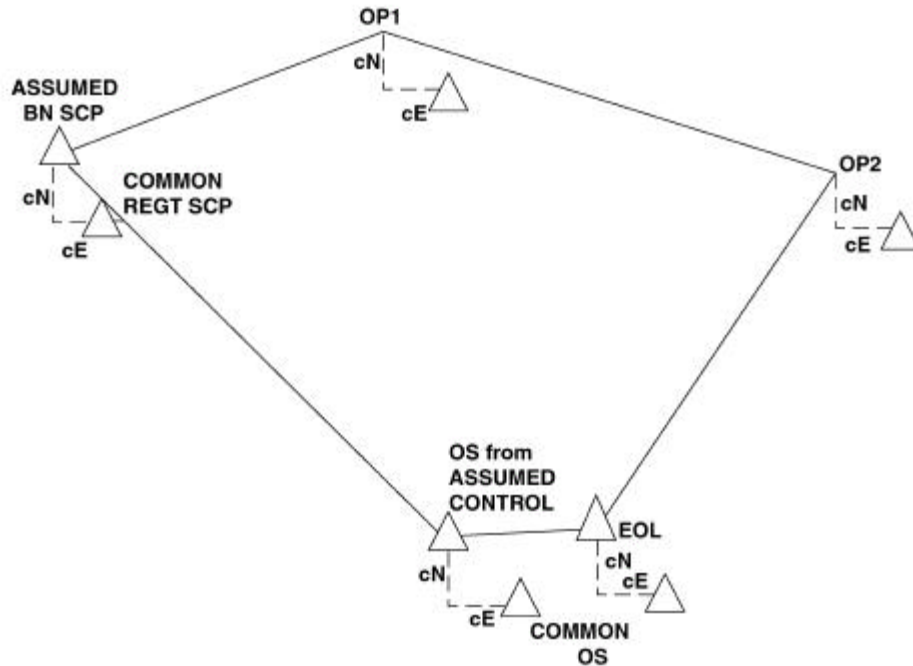

Figure 1-7. Sliding the Grid.

Step 2. Apply the corrections determined in Step 1 to the easting and northing coordinates of each critical station in the survey. For example, if the coordinates for an OS as determined by the PADS are E: 556782.9 N: 3836346.9, determine the common grid coordinates as—

	Easting	Northing
OS	56782.9	3836346.9
Correction	+11.3	-4.1
Common OS	56794.2	3836342.8

As long as a survey is maintained in the memory of a survey computer program, the easiest way to convert a lower echelon network to the higher echelon grid is to enter the higher echelon data in the survey computer and recompute the survey.

Swinging and sliding the grid are performed at the same time. When swinging and sliding the grid over individual legs, perform Steps 1 through 5.

Step 1. Determine the azimuth correction between the higher and lower echelon networks. For example, the azimuth assumed by a battalion survey section is 4390 mils, the azimuth over that leg as determined by the higher echelon section is 4387.217 mils. Determine the correction as—

Higher	4387.217
Lower	-4390.000
Correction	-2.783 mils

Step 2. Compute the azimuth and distance between the starting station and each critical station using the coordinates determined in the lower echelon survey.

Swinging and Sliding the Grid

Swinging and sliding the grid converts a lower echelon network to the higher echelon network when the azimuth difference is 2 mils or greater and the RE is 10 meters or greater. This is usually necessary when position and azimuth is assumed in conventional survey methods. If an azimuth is determined by the PADS, differential GPS methods or astronomic observations, the azimuths between higher and lower echelons will usually be within the 2-mil specification. See figure 1-8.

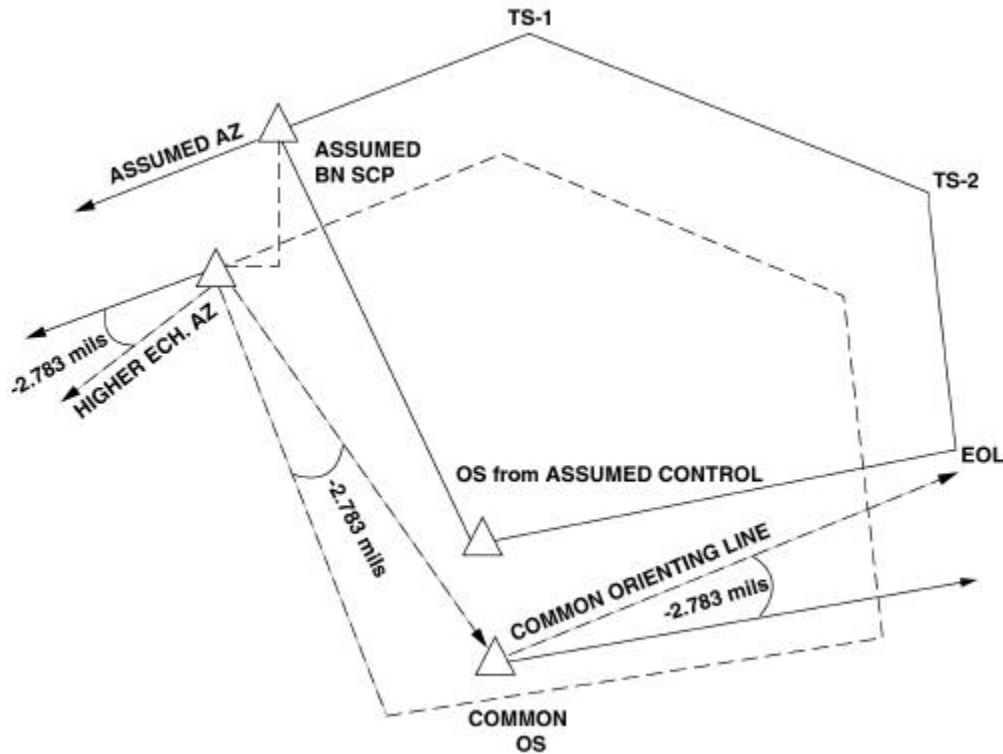

Figure 1-8. Swinging and Sliding the Grid.

Step 3. Determine the adjusted azimuth to each critical station by applying the azimuth correction determined in step 1 to each azimuth determined in Step 2. For example, if the azimuth computed in Step 2 from the starting station to the OS is 2745.354 mils, determine the adjusted azimuth as—

Computed	2745.354
Correction	-2.783
<u>Adjusted Azimuth</u>	<u>2742.571 mils</u>

Step 4. To place the critical station on common grid, use the higher echelon coordinates, the adjusted azimuth from Step 3, and the computed distance from Step 2, compute a dogleg (offset) coordinate for each station.

Step 5. To determine the common azimuth of a critical line; e.g. orienting line or target area base, apply the azimuth correction from Step 1 to the azimuth determined in the original computations. This places the azimuth line on a common grid. For example, if

the azimuth from the OS to the EOL in the original computations was 1537.876 mils, determine the adjusted (common) azimuth as—

Computed	1537.876
Correction	-2.783
<u>Common Azimuth</u>	<u>1535.093 mils</u>

Leveling the Grid

Leveling the grid converts a lower echelon network to the higher echelon network when the elevation difference is 2 meters or greater. This will usually occur with a map spot and an absolute GPS elevation. Leveling the grid is performed at the same time as the other conversion to common methods.

When conventional methods are used, it may be easier to recompute the survey.

When using differential GPS survey methods, the conversion to common control is performed in the software. For RTK/OTF operations, conversion to common control is performed by calibrating the kinematic network. For a static GPS network, conversion to common control is performed by changing the fixed position of the assumed station in the TrimNet software.

Leveling the grid by converting individual stations can be performed as shown in Steps 1 through 3.

Step 1. When leveling or leveling and sliding the grid, determine the elevation correction between the lower and higher echelon data by subtracting the lower echelon elevation from the higher echelon elevation. For example, a battalion survey section updates its PADS with a PLGR elevation of 356 meters. A regiment survey team later provides common control over that station using differential GPS methods and determines an elevation of 352.8.

Higher	352.8
– Lower	356.0
Correction	<u>–3.2</u> mils

Step 2. Apply the corrections determined above to the elevation of each critical station in the survey. For example, if the elevation for an OS as determined by PADS is 398.3, the common grid elevation is determined as—

OS	398.3
Correction	–3.2
Common OS	<u>395.1</u> meters

Step 3. When leveling the grid is performed with swinging or swinging and sliding the grid, the higher echelon elevation is used in place of the lower echelon elevation in the computations of the doglegs to each critical station.

CHAPTER 2. PLANNING

The commander initiates survey planning requirements in the form of an operation order. He states his intent, the scheme of maneuver, the rate of movement, the anticipated enemy threat, and the critical phases of battle.

The survey plan must be simple and adaptable to the chaotic and rapidly changing environment of the battlespace. It must provide required control, provide checks, and be timely.

Ultimately, the survey plan will result in an order issued to the survey section. Execution of the order will ensure accurate and timely fires are delivered, and help alleviate any lapse in fire support to the maneuver commander.

Survey planning is conducted at all levels at the same time. Coordination between higher, lower, and adjacent survey sections during planning will ensure even distribution of the work load, eliminate duplication of work, and provide a focus of effort in establishing a common grid.

The survey officer must have a thorough understanding of the commander's intent and concept of operations and the artillery fire plan. This understanding will allow him to prioritize the surveys that should be conducted first and what time constraints he has for completion. Coordination with the commander's staff in developing the survey plan (primarily with the S-3 and S-2) is paramount.

The survey officer will generally receive the commander's guidance through the S-3. He can provide the survey officer with operational information that will affect the survey plan. The S-3 must be kept informed of all survey related problems that will affect the firing units and fire support assets.

The S-2 can make available mapping, charting, and geodesy products as well as friendly and enemy

situations for the area of operations. He may also request information be obtained during the course of survey operations on routes of march, road conditions, terrain conditions, volume of refugees, etc. He can then consider all the other factors that will impact the survey plan.

The Artillery Fire Plan

The artillery fire plan is part of the maneuver commander's operation order. It contains information on how artillery will support the maneuver element. The following are some essential elements:

- Allocating all artillery assets.
- Projected changes to allocating artillery assets based on tactical contingencies in the operation order.
- The artillery commander's concept of artillery support.
- Priorities of survey.
- Locations of command posts.
- Artillery targets. This may consist of a target list worksheet and scheduling worksheet. A target list is also included in the fire support plan that includes all targets, not just artillery targets. This list may be needed for planning target surveys for non-artillery targets.
- Initial positions and planned movement of units. An overlay may be included. Unit boundaries and range fans are shown on the overlay.
- Artillery target overlay. This overlay includes artillery targets, fire support coordinating measures (FSCMs), and unit boundaries.
- Observation and target acquisition plan. It outlines mission statements for collecting specific information, reporting requirements, positioning, and sectors of coverage of the artillery's target acquisition assets; e.g., forward observers (FOs), OPs, and UAVs/RPVs.

The Survey Plan

The survey plan is written in the five-paragraph order format and is contained in enclosure 6 of the artillery fire plan, Tab B to Appendix 19 (Fire Support) of Annex C (Operations) of the Operation Order/Plan. The five paragraphs in the survey plan will not duplicate the higher level planning documents. Only information necessary for the survey teams to complete their mission is included. The five-paragraph order as it pertains to a survey plan follows.

Situation

This paragraph describes the general situation.

Enemy covers intelligence information regarding the enemy situation as it affects survey (routes, weapons, etc.).

Friendly covers the friendly (higher, lower, and adjacent units) situation.

Attachments and Detachments covers units who can support the survey mission; e.g., security or maintenance or units attached to the section.

Mission

This paragraph is a clear, concise statement of what must be accomplished.

Execution

This paragraph consists of several subparagraphs that answer the questions *who, what, where, when, and commander's intent*. It further establishes general methods to be used and the priority of work.

Concept of Operations describes in detail the survey methods to be used.

Specific Instructions For Each Party contain specific instructions each team needs to accomplish its portion of the mission. Survey control to be used by this team, general locations (6-place grids) for

required control, and information which deviates from SOP are listed.

Coordinating Instructions contains instructions/information common to two or more parties (timelines, rally points, etc.)

Administration and Logistics

This paragraph covers information to ensure service support is adequate for the mission; e.g., rations, ammunition, aid stations or handling of prisoners.

Command and Signal

This paragraph covers information such as the location of the survey officer, survey chief, chain of command, frequencies, call signs, medical evacuation (MEDEVAC) procedures, and communications between survey teams.

Mission, Enemy, Terrain and Weather, Troops and Support Available-Time Available

In forming the survey plan, the survey officer must make an estimate of the situation. Mission, enemy, terrain and weather, troops and support available-time available (METT-T) provides the framework for that estimate. Considerations include but are not limited to the following.

Mission

The tactical mission of the artillery unit and supported unit(s) will determine the priority of survey work and the accuracy required. It also gives an understanding of the tactical situation surveyors will be operating in (defensive, offensive, high intensity or low intensity). Rules of engagement, FSCMs, and boundaries may hinder survey operations by restricting survey methods or access to survey control points.

Enemy

The enemy situation has a tremendous influence on survey operations. Disposition of enemy troops may

interfere with or limit the movement and capabilities of survey personnel. Communications restrictions (radio silence or jamming) can greatly reduce a survey team's effectiveness.

The ability of the enemy to degrade survey operations by denying terrain or route of march is a prime consideration. Surveyors must be able to readily identify enemy vehicles and positions they may encounter, and be trained to call for and adjust fires on those targets. The survey section must be equipped and trained to take immediate action to respond to the type of enemy force they may encounter (regular troops, militia, guerrillas, etc.) Enemy air capabilities are also of importance due to the vulnerability of survey teams. Lengthy initialization times with PADS or occupying traverse and GPS stations leave surveyors exposed to air attack and observation.

Terrain and Weather

Terrain and weather encountered will be a primary factor in determining the survey method, and, to some extent, the priority of installations to be surveyed first. The survey planner must be familiar with the influence of terrain and weather on survey operations. Adverse weather conditions greatly reduce the capability of the survey teams. Fog, rain, snow, or dust can make observation through optical instruments virtually impossible. Extreme heat or cold decrease efficiency, and increase the time needed to complete survey. Reconnaissance to determine the suitability of terrain for the installation to be surveyed is vital. Alternative areas may be required once the proposed position has been reconnoitered.

Troops and Support Available

Personnel and equipment available to perform the survey mission greatly affects the plan. The level of training determines the methods and time required to complete the mission. Availability and condition of surveying equipment may further dictate what methods can be used and the time required. Availability of fire support depends largely on the tactical mission of the artillery unit; i.e., direct support

(DS), general support (GS), general support-reinforced (GS-R) or reinforce (R).

Time Available

The time available to complete the survey is critical in planning. Providing the required data within the time allotted may result in a loss of accuracy. The commander must be advised of any possible loss in accuracy due to time constraints and decide if this is acceptable. Time limitations may often be implied or ambiguous and require clarification.

METT-T elements are interrelated and must be considered together. It is a dynamic framework, *not* a checklist. Other factors may have an effect on a survey plan but are not necessarily covered in METT-T; e.g., refugees or political/diplomatic agreements.

Space and Logistics

For the survey planner, space is restricted to his operational area, within his unit's boundaries. Available survey control may only exist outside these boundaries thus requiring additional coordination and planning.

Availability of logistical support must be considered in all planning. The survey section has a wide array of equipment that may need servicing or repair. Regardless of the survey method used, surveyors rely heavily on their motor transport assets to complete their mission. At the same time they are operating over a broad area far from their logistics base. Chow, ammunition, water, and petroleum, oil, and lubricants (POL) are just some of the supply issues that must be addressed.

In addition to evaluating the factors of METT-T, the survey officer must also understand the characteristics of the different survey methods, their advantages and disadvantages, and their impact on mission accomplishment.

Position and Azimuth Determining System

The PADS is a vital survey asset. Its primary advantage is how fast it provides survey data. Consider the following:

- Is existing control accessible with a military vehicle? If not, is existing control within 16 meters of a location that will allow autoreflexion?
- Is the mission within the PADS operational limits?
- Speed limitations for PADS vehicle:
 - Cross-country: 10 kilometers per hour.
 - Unimproved roads: 25 kilometers per hour.
 - Improved roads: 50 kilometers per hour.
- Time limitations for PADS vehicle:
 - 30-day bias: 2-3 hours.
 - Initialization: 30-45 minutes.
 - Update/mark: 5 minutes.
 - Autoreflexion: 15 minutes.
 - Mission time: unlimited.
- Is existing common control available within 55 kilometers of the planned update point that can be used for future updates?
- Does PADS support the operational ellipsoid in the operation order? If not, is user-defined data available?
- Does PADS meet the accuracy requirements for the unit being supported?

Traverse

Traverse is the preferred *conventional* survey method. Consider the following:

- Is existing control available of the proper accuracy? Are azimuth marks available for computed azimuths, or do azimuths have to be determined by astronomic observations?
- Is the area of operations within the UTM north and south limits? If not, can the section perform manual computations?
- Planning considerations:
 - Distances traversed: 1-20 kilometers per hour (line of sight-dependent).
 - LOS clearing (jungle): 100 meters per hour.

- Forest: 1 kilometer per hour.
- How far is existing control from the area requiring survey?
- How much line of sight cutting is required? Is engineer equipment available to help cut line of sight; e.g., chain saws, weed eaters or bulldozers?
- Is the control accessible by military vehicles or does equipment have to be carried into the area?
- What are the accuracy requirements?
- What means of communications between team members is available? (Radio, panel marker, hand and arm signals, etc.)
- Will traverse provide a timely enough response to the need for survey data?

Intersection

This is the primary method of survey used to determine target locations. Considerations for intersection include visibility, the accessibility and availability of control, azimuth marks, and communications between teams. Intersection can also provide update and initialization points for PADS or locate other critical points other than targets.

Astronomic Observations

When weather conditions allow the observation of celestial bodies, the arty astro method is the primary means used to determine an azimuth. The firing battery's primary method of astronomic observation is hasty astro. Consider the following:

- Do weather conditions allow observations of celestial bodies?
- Are celestial bodies within allowable observation windows relative to time and position?
- What is the required accuracy?
- Is accurate time available?

RTK/OTF GPS Survey

RTK/OTF is the newest method available to Marine artillery surveyors. Accuracy achieved is well above that required for most artillery survey missions. It is the fastest method available to provide survey data.

Consider the following:

- Is existing control available or will the base station be operated in the absolute mode? If control is available, is there enough control of adequate accuracy available to be used as calibration points?
- Are enough communications assets available to provide each GPS team with a voice radio and an additional single channel ground and airborne radio system (SINCGARS) radio for digital communications between the receivers?
- Have communications lines of sight been verified in the areas requiring control? If not, has a map reconnaissance shown that communications lines of sight are clear?
- Are alternate sites available for the base station when communications are not available or the tactical situation forces evacuation of the original position?
- What is the required accuracy?
- Is electronic line of sight to the satellites available? If not, is engineer equipment (chain saws, weed eaters, bulldozers, etc.) available to help cut electronic line of sight?
- Are planned base receiver sites within 10 kilometers of installations requiring survey? If not, are supplemental positions available?
- What are the enemy radio direction finding assets?

Static/Rapid Static GPS Survey

Static/rapid static survey is the most accurate method available. Static GPS methods provide geodetic level accuracy and establish high order survey networks. Consider the following:

- Is time available for occupation of sites and post processing?
- Is existing control of sufficient accuracy to allow for adjustment of GPS measurements?
- If no control is available, can absolute stations be established distant enough (at least 50 kilometers) from each other to allow for adjustment of GPS measurements?

The Environment

Survey operations must continue regardless of environmental factors such as climate and terrain.

Arctic Areas and Cold Weather Conditions

Arctic areas and cold weather conditions provide the surveyor with unique problems that must be overcome if the surveyor is to provide adequate survey control to supported units. For the most part, arctic regions provide the same problems as cold weather conditions anywhere else. When committing survey teams to field operations in extreme cold, the effects of ice, movement, snowfall, prevailing wind, light refraction, and other peculiarities must be considered.

Cold seasons can provide the advantages of reduced transportation difficulties in river, lake, and tundra regions. Survey control can be extended easily along riverbanks, large bodies of water or over the relatively level, treeless plains of the arctic tundra.

Equipment malfunctions increase in cold weather conditions.

PADS operates without performance degradation at temperature extremes as low as -50°F (-45°C). Initialization will take longer but the heat exchanger exhaust can be covered by a blanket or field jacket to help reduce heat loss. The vehicle heater should be used along with windbreaks to maintain an operational temperature for the PADS.

Optical equipment must be acclimatized before use in cold weather conditions. Temperature equilibrium will affect both the scales and optics of equipment. Optical equipment should be stored in an area with conditions as close to possible as those conditions where they will be used.

Personnel must be trained in the use of cold weather equipment and cold weather field expedients.

Existing survey control in arctic regions is sparse to say the least. Locating existing control will take longer than in warm weather conditions. This is due in part to

a lack of reference points to help identify or witness the stations as well as the need to dig through snow and ice to find it. Surveyors must understand that a pick and shovel can cause severe damage to a survey control point and that care must be taken when digging for control.

Desert Areas

A very large percentage of the world is covered by desert. Operations in desert regions are a common occurrence. These regions provide for their own unique obstacles for surveyors. While the open terrain and normally clear skies allow for long lines of sight and an abundance of celestial bodies for observation, other problems do exist.

PADS operates without performance degradation at temperature extremes as high as 125°F (50°C). Sand and dust will clog the PADS air vents and cause the PADS to quickly overheat. Covering the PADS to protect it from sand will have the same effect as the sand itself. Post operation maintenance including blowing the air vents clean is more important in desert regions than in any other environment.

Optical equipment must be shaded during leveling and protected from sand when not in use. Leveling vials increase about 2 graduations past true center in temperatures above 100°F and at temperatures reaching 120°F, leveling may be impossible. The most obvious obstacle to survey operations with optical equipment is heat waves. Eyestrain is more prevalent and instrument operator changes are more frequent. Observing long distances may not be possible. At those temperature extremes, survey operations using optical equipment should be avoided.

Personnel must be trained in desert operations. Noise and light discipline are more important in desert regions than other environments. Personnel should be trained in desert survival techniques since the time necessary to acclimatize is not normally available.

Existing control in desert areas, like arctic regions, is sparse and hard to locate. The lack of reference points and blowing sand will increase the time needed to locate these stations.

Jungle Areas

Jungle areas provide obstacles to surveyors such as heat, humidity, and a lack of adequate mapping products. Line of sight is a major concern, even for GPS operations, depending on the type of canopy.

Jungle heat will effect the equipment much like desert heat; however, humidity will increase the effects of heat on personnel and create fogging problems for optical equipment.

Maps for most jungle areas are inadequate except for coastlines, rivers, and roads.

Existing control will usually be located on mountaintops. This may preclude the use of PADS with those stations. Optical line of sight is a major problem for conventional teams, as is electronic line of sight for GPS teams.

Urban Areas

Survey in built-up or urban areas is restricted by line of sight, communications, the enemy situation, and accuracy.

PADS operations in urban areas may be the preferred method due to line of sight restrictions. Communications are also restricted due to the limited range of FM radios in built-up areas.

The tactical situation has a strong influence on survey operations in urban areas. The enemy can be well hidden in sewers, ladder wells, and windows or on rooftops. Enemy obstacles; e.g., mines or barricades, may deny the use of certain terrain or routes needed for the extension of survey through or around a built-up area.

Locations of installations are a concern in urban areas. OPs may have to be placed on rooftops, firing positions in airports, parks, or riverbeds. Reconnaissance and planning are essential for proper use of survey assets in urban areas.

Mapping, Charting, and Geodesy

Often, mapping products and existing control will be of a different ellipsoid and datum combination than prescribed in the operation order. Surveyors may be required to perform datum-to-datum transformations from the local datum to the operational datum and develop overlays and provide insight to datum problems and transformation accuracy. Most fire support assets and survey computational devices do not provide for computations outside of the UTM system or the nonstandard grid zones that exist in and around Norway. See chapter 4.

BAMCIS

The steps for generating the survey plan are found in the acronym BAMCIS.

Begin Planning

Review the commander's intent, scheme of maneuver, and the artillery fire plan. This information is used with trig lists and intelligence information to develop maps and overlays that include survey control, current and planned firing positions, and fire support asset locations.

Priorities can also be determined at this time as to the installations or control that will be surveyed first.

A warning order should be issued to the survey chief and party chiefs to allow for preparation of personnel and equipment to conduct the reconnaissance.

Using the information above and knowledge of the capabilities and limitations of the section's personnel and equipment, make a tentative plan. Also perform a map recon and mentally walk through the tentative plan to ensure it will meet all requirements.

Arrange for Reconnaissance

Once the tentative plan is formulated, a thorough ground reconnaissance should be made (if time and the tactical situation permit.)

The survey chief ensures the required personnel and equipment are prepared to conduct the reconnaissance.

The route of march (with check points) and a brief itinerary should be provided to the S-2 and S-3. This will allow for coordination with higher, lower, and adjacent units, ensuring safe passage of the teams involved. Consideration should be given to challenges, passwords, and communications during the recon.

Coordination of the logistics requirements of the reconnaissance should be addressed to the S-4. Supplies, fuel, repairs, etc., may be provided by units located in or near the area to be reconnoitered.

Additional security requirements should also be requested through the battalion.

Make Reconnaissance

Only those Marines essential to accomplish the recon should accompany the survey officer. Limit the amount of equipment taken. During the recon mission the survey officer should—

- Verify map data.
- Determine validity of his plan.
- Assess trafficability of routes and the condition of terrain.
- Note weather conditions.
- Note changes to any intelligence information received from the S-2.
- Make any changes necessary.

Complete the Plan

Upon returning from the reconnaissance the survey officer finalizes his plan. The survey order is written and briefed to the S-3. If time permits, the survey plan is added to the artillery fire support plan. The S-2 is also briefed on any changes to the intelligence fire support plan. The S-2 is also

briefed on any changes to the intelligence information he provided previously.

Issue the Order

The survey officer issues the survey order to the entire section in the form of a five-paragraph order. The order may be written or oral. If oral, certain information should be provided to the survey teams separately, i.e., strip maps or trig lists.

The order should be simple, direct, and thorough. All the information required to complete the mission should be given to the surveyors to allow for action in the absence of further orders. The order should describe what needs to be accomplished and when. The priorities, accuracy, and the methods to be used should be stated together. Once teams depart they must be able to use their initiative and the information from the order to deal with the friction that is bound to occur.

Use of a terrain model and/or a map during the brief is of great importance for Marines to visualize the mission and what is expected of them.

Time should be provided at the *end* of the brief for any questions that may arise. This ensures a thorough understanding of the mission.

Any acceptable deviations from current SOP should be specifically noted.

Supervise

Once the survey order has been issued and teams begin their portions of the plan, the survey chief supervises conduct of the mission while the survey officer begins the planning process all over again, and coordinates with the S-3 on future operations.

As the current mission progresses and the situation changes, subsequent orders will be issued as frag orders. The survey chief must maintain close liaison with the survey officer and add to his situational awareness.

Survey Sketch

A survey sketch must reflect the survey order. It is prepared and provided to the survey teams before the order is issued so that each portion of the survey mission is understood. The sketch should be as detailed as possible without hindering the flexibility of the survey plan.

Draw the sketch to scale. Use a large-scale map or plotting chart for surveys covering large areas or to enlarge small surveys.

Make the sketch self-explanatory.

Show all known and required control. General locations (6-digit grids) can be used for required installations.

Label all points.

Draw a north arrow for orientation purposes if a map is not used.

Include routes that must be taken for security purposes and restricted areas; e.g., hazards or obstacles.

For PADS operations, a detailed sketch is not always necessary. Often, a strip map or route overlay that includes known and required control may suffice.

Prepare a sketch for an RTK/OTF roving team much the same way as that for a PADS team.

For a static GPS survey, include all stations in the network, not just the stations planned for that team. Include prescribed routes and in some cases pre-planned observation times.

A conventional survey sketch must be more detailed than a PADS team sketch. Along with the information above, show—

- All traverse stations.
- All horizontal angles drawn from the rear station to the forward station.
- Starting and closing azimuths as a dashed line with an arrow pointing towards the azimuth mark.

Since the survey sketch includes a large amount of information that can be useful to the enemy, it must not be compromised. Destroy it if a serious threat of capture exists.

CHAPTER 3. BASIC GEODESY

SECTION I. THE GEODETIC SYSTEM

A geodetic system serves as a framework for determining coordinates on the Earth's surface with respect to a reference ellipsoid and the geoid. It consists of both a horizontal datum and a vertical datum.

The Geoid

The geoid is the equipotential surface in the gravity field of the Earth that coincides with the undisturbed mean sea level (MSL) extended through the continents. It is the zero reference for elevation, a closed surface of equal gravitational force. It is perpendicular to the direction of gravity and closely approximates MSL and the extension of MSL through the land masses of the Earth.

The geoid is affected by variances in the density, type, and amount of land mass that push up through the water or lie below it, causing dips and swells over its surface, thus conforming to an equal force of gravity over that surface. The dips and swells are called undulations. See figure 3-1.

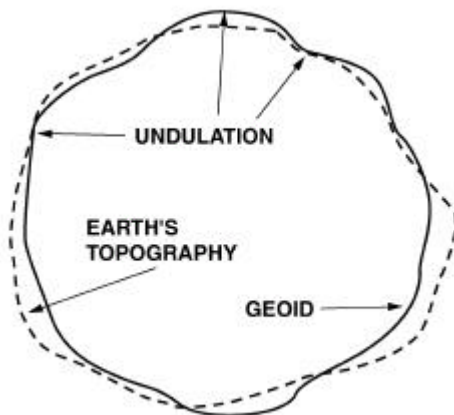

Figure 3-1. Undulation.

Gravity pulls perpendicular to the geoid. This means that a plumb line lies perpendicular to the geoid and establishes a vertical direction of measurement. An adjusted level vial is centered when it lies parallel with the geoid and establishes a horizontal reference at a specific location. The geoid provides a common reference for elevation wherever the surface of the geoid intersects a land mass is generally referred to as approximate MSL.

Elevation is the distance between a point on the Earth's surface and the geoid, measured along a line perpendicular to the geoid (plumb line). Points lying outside (above) the geoid have a positive elevation; points inside (below) the geoid have a negative elevation. Elevation can be referred to as orthometric height or MSL height. Elevation is labeled "H". See figure 3-2.

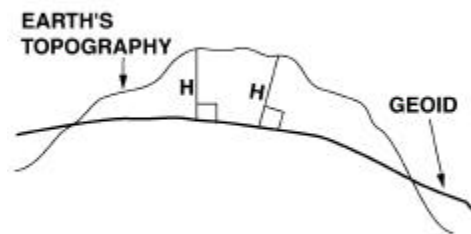

Figure 3-2. Elevation.

Ellipsoid Defining Parameters

An ellipsoid is a surface whose plane sections (cross sections) are ellipses or circles, or the solid enclosed by such a surface. It can be more easily identified as a sphere that is flattened or squashed on the sides or the top and bottom. In geodesy, we use an ellipsoid that is

flattened on the top and bottom; i.e., an oblate ellipsoid. The terms ellipsoid and spheroid are interchangeable. See figure 3-3.

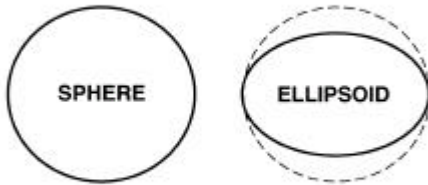

Figure 3-3. Ellipsoid.

An ellipsoid is generally defined by three parameters (or dimensions) that provide the size and ellipticity of the ellipsoid. See figure 3-4.



Figure 3-4. Defining Parameters.

The semi-major axis is the distance along the equatorial plane of an ellipsoid from the center of that plane to its edge or the equatorial radius. It is referred to as the long radius of an ellipsoid or one-half of the largest diameter and is labeled “a”.

The semi-minor axis is the distance in a meridional plane from the center of the plane to its closest edge,

or the polar radius. It can also be referred to as the short radius of the ellipsoid or one-half of the shortest diameter. It is labeled “b”.

The flattening is the ratio of the difference between the equatorial and polar radii (semi-major and semi-minor axes to the equatorial radius (semi-major axis). It is labeled “f”. It is more commonly expressed as the inverse of flattening (1/f). Flattening can also be called ellipticity.

Other defining parameters for ellipsoids are discussed in NIMA TR 8350.2, *Department of Defense World Geodetic System 1984*, and DMA TM 8358.1, *Datums, Ellipsoids, Grids, and Grid Reference Systems*. Parameters include Earth gravity information, angular velocity, and eccentricity. Surveyors do not need to understand these parameters; they are not discussed in this publication.

The three defining parameters discussed above will not always be available. A user can compute the third parameter from two known parameters using the following formulas:

For the semi-minor axis (b) use $b = a(1-f)$

Example: Geodetic Reference System (GRS)-80 ellipsoid

First, determine f: $1/f = 298.257222101$
so $f = 0.00335281068118$

Second, determine b: $b = a(1-f)$
 $a = 6378137 (1 - 0.00335281068118)$
 $b = 6356752.31414$
NIMA published value for b is 6356752.3141.

For flattening (1/f) use $f = (a-b)/a$

Example: GRS-80 ellipsoid

First, determine f: $f = (a-b)/a$
 $f = (6378137 - 6356752.3141)/6378137$
 $f = 0.00335281068751$

Second, determine 1/f:
Flattening = $1/0.00335281068751$
 $1/f = 298.257221538$
NIMA published value for 1/f is 298.257222101.

These computations may provide a quantity that differs slightly than the accepted NIMA parameters. This is generally due to rounding and is considered insignificant for many geodetic applications and for all artillery survey applications.

Reference Ellipsoid

The oblate ellipsoid is used in geodesy because it is a regularly shaped mathematical figure. Unlike the geoid, there is no undulation. If the geoid were regularly shaped, there would be no need for an ellipsoid. We would simply compute surveys referenced strictly to the geoid. Since that is not the case, an ellipsoid is defined and then fixed to a specific location (usually located on the surface of the geoid) and orientation that makes it closely resemble the surface of the geoid. This is accomplished by establishing a horizontal datum.

Once an ellipsoid is fixed by a specific datum, it becomes a reference ellipsoid.

Reference ellipsoids can be local in extent or global. If the ellipsoid resembles only a small region of the geoid and is fixed to a point on the surface of the Earth, it is local. If the ellipsoid is fixed to the center of mass of the Earth and is designed to resemble the geoid as a whole, then it is global and is called an Earth-centered Earth-fixed (ECEF) ellipsoid. See figures 3-5 and 3-6.

Geoid Separation

Geoid separation is the distance from the geoid to the reference ellipsoid, measured along a line that is perpendicular to the ellipsoid. It is positive when the geoid lies outside the ellipsoid; negative when the geoid lies inside the ellipsoid. Geoid separation is labeled “N” and is also called geoidal height or undulation of the geoid. See figure 3-7.

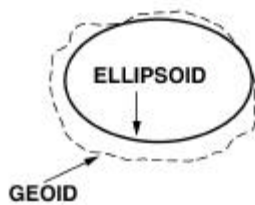

Figure 3-5. Local Reference Ellipsoid.

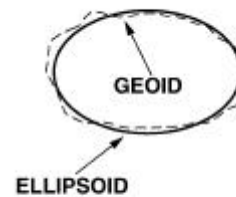

Figure 3-6. ECEF Ellipsoid.

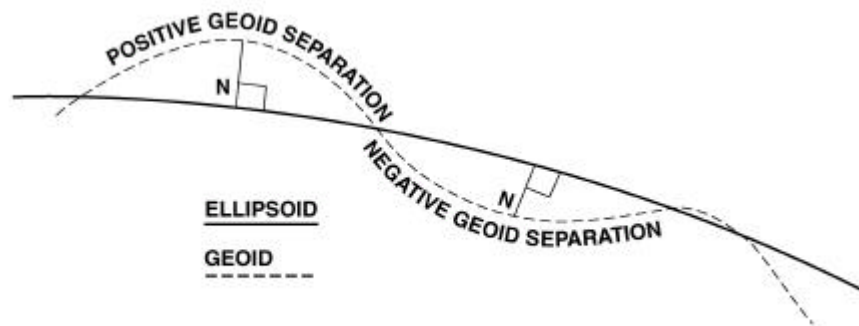

Figure 3-7. Geoid Separation.

Ellipsoid Height

Ellipsoid height is the distance from a point on the Earth's surface to the reference ellipsoid, measured along a line that is perpendicular to the ellipsoid. Ellipsoid height is labeled "h" and can be referred to as geodetic height. See figure 3-8.

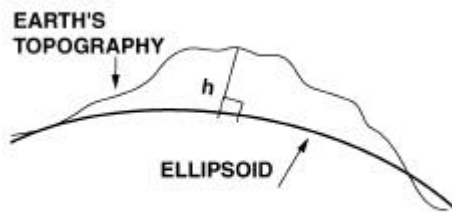

Figure 3-8. Ellipsoid Height.

The relationship between ellipsoid height (h), elevation (H), and geoid separation (N) is shown in the formula $h = H + N$. See figure 3-9.

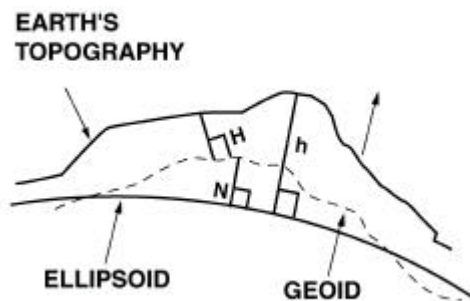

Figure 3-9. Relationship between h, H, and N.

Datums

A datum is any numerical or geometrical quantity or set of such quantities which may serve as a reference or base for other quantities. Two types of datums are

generally considered by surveyors: Vertical and horizontal. When the term datum is used by itself, it is usually referring to a horizontal datum. Vertical and horizontal datums are generally defined separately from each other. For example, horizontal positions in the Korean peninsula may be defined by the Tokyo Datum referenced to the Bessel ellipsoid; while vertical positions are defined by the geoid referenced to the MSL datum.

Vertical Datums

A vertical datum is a level surface or arbitrary level to which elevations are referred. Usually, the geoid (mean low level) is that surface. However, other vertical datums may include MSL, the level at which the atmospheric pressure is 29.92 inches of mercury (1013.2 millibars of mercury {MBS}) or an arbitrary starting elevation. Vertical datums are usually defined as a surface of "0" elevation and are also called altitude datums.

Since it is impossible to determine exactly where the geoid intersects a land mass, it is impossible to use the geoid as the actual vertical datum. Historically, tide gauge measurements were averaged over 19 years to establish a local MSL. (These MSL datums are very close to the geoid but not exactly.) For this reason level lines run from tide gauge marks in different regions do not connect exactly at the same elevation. In the United States, the National Geodetic Vertical Datum (NGVD) of 1929 replaced the MSL 1929 and has since been updated to the North American Vertical Datum (NAVD) 1988. This new vertical datum, based on tide gauge measurements and precise geodetic leveling, has extended a common vertical network to most of the continental United States. The NAVD is considered to be within a few meters of the geoid. There is greater uncertainty in the relationship between other local vertical datums and the geoid throughout the world.

Because of the uncertainty between local MSL datums and the geoid and unknown exact relationships between those datums, all elevations should be considered to be referenced to the MSL datum to shift between vertical datums.

Horizontal Datums (Geodetic Datums)

A horizontal datum is a set of quantities that fix an ellipsoid to a specific position and orientation. The point where the ellipsoid is fixed is called the datum point. There are two types of datums: surface-fixed and geocentric.

A surface-fixed horizontal datum is a set of quantities relating to a specific point on the surface of the Earth that fixes an ellipsoid to a specific location and orientation with respect to the geoid in that region. The center of the ellipsoid and the center of mass of the Earth do not coincide. Examples are North American datum (NAD) 27, Tokyo, and ARC 1950. See figure 3-10.

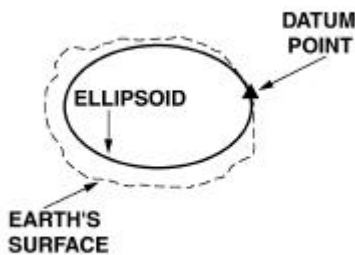

Figure 3-10. Surface-Fixed Datum.

A surface-fixed datum is generally defined by five quantities: latitude (ϕ), longitude (λ), and geoid height (N) at the datum point; semi-major axis (a), and either semi-minor axis (b) or flattening (f) of the reference ellipsoid. A geodetic azimuth is sometimes listed as a defining parameter for a horizontal datum.

A surface-fixed datum can cover very small areas to very large regions of the Earth. The geoid separation at the datum point is generally zero. However, as you move away from the datum point, the geoid separation increases, creating the need for a new datum. Often, the same ellipsoid fixed to a different location and orientation is used.

A geocentric horizontal datum specifies that the center of the reference ellipsoid is placed at the center of mass of the Earth. This point at the center mass of the

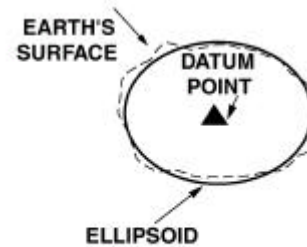

Figure 3-11. Geocentric Datum.

Earth is also the datum point. Examples are the World Geodetic Systems (WGSs). See figure 3-11.

At least eight constants are required to define a geocentric datum. Three specify the location of the origin of the coordinate system; three specify the orientation of the coordinate system; and two specify the reference ellipsoid dimensions.

Geocentric datums generally cover a large area of the world and in some cases are global in extent. The geoid separation remains relatively small for the entire region covered by the datum. The WGS developed by the DMA are global coverage datums; WGS 84 is the newest and most accurate. A WGS offers the basic geometric figure of the Earth (ellipsoid) as well as an associated gravity model (geoid). This is why the geoid separation remains relatively small over the entire system (generally less than 102 meters within WGS 84).

Multiple Datum Problems

Over 1,000 datums exist. Practically every island or island group in the Pacific Ocean has its own datum. Many areas are covered by multiple datums. This causes the most concern for surveyors who must decide which datum to use and how to convert data between them. Mapping products established from different datums will not match at the neatlines nor will grid lines meet. Target acquisition assets will provide inaccurate data to firing systems if the target acquisition system is not on the same datum as the firing system.

The WGS was developed to create a global system that would alleviate many of these problems. NIMA will eventually revise all mapping and charting products to reference WGS 84 as the datum/ellipsoid for the entire world except for the United States. Mapping and charting products for the United States will reference GRS 80 as the ellipsoid and NAD 83 as the datum.

All datums are defined relative to WGS 84. For this reason, transformations between datums are performed from and to WGS 84. When converting from surface-fixed datum 1 to surface-fixed datum 2, first transform datum 1 to WGS 84; then transform the WGS 84 datum to datum 2.

To develop datum shift parameters, coordinates on both datums at each of one or more physical locations must be known. Typically, for shifts from a local datum to WGS 84, the WGS 84 coordinates were derived from Doppler satellite observations over points with already existing surface-fixed datum coordinates. Several methods of datum transformation are available. The rest of this section discusses them.

Seven Parameter Model

This geometric transformation model assumes that the origins of the two coordinate systems are offset from each other, that the axes are not parallel, and that there is a scale difference between the two datums. Data from at least three well-spaced positions are needed to derive a seven parameter geometric transformation. The seven parameters come from differences in the local and WGS 84 cartesian coordinate. There are three axis rotation parameters, a scale change, and three origin shift parameters (ΔX , ΔY , ΔZ). The origin shift parameters are the coordinates of the origin of the local reference ellipsoid in the WGS 84 cartesian coordinate system. Use of the seven parameter method is prescribed by standardization agreement (STANAG) 2211, *Geodetic Datums, Ellipsoids, Grids, and Grid References*, for some applications in Europe and England. It is considered more accurate than the five parameter model. See figure 3-12.

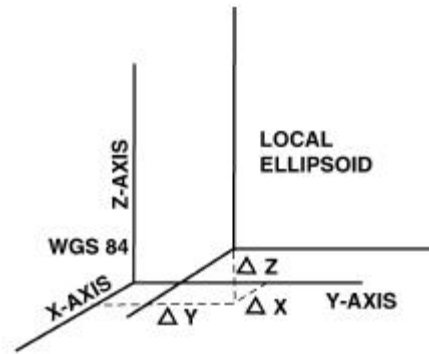

Figure 3-12. Origin Shift Parameters.

Five Parameter Model

This model considers only the relative sizes of the ellipsoids and the offset differences in their origins. The five parameters are the difference in the semi-major axes ($\Delta\alpha$), the difference in flattening ($\Delta f \times 10^4$), and the three origin shift parameters (ΔX , ΔY , ΔZ). Origin shift parameters are the coordinates of the origin of the local reference ellipsoid in the WGS 84 cartesian coordinate system. This model is used in computing standard Molodensky equations and is considered accurate to 5 to 10 meters.

WGS 72 to WGS 84

Formulas transforming between these two geocentric datums were created when WGS 84 was developed. These formulas are discussed in detail in NIMA TR 8350.2. Care must be taken when using them to determine the source of the WGS 72 coordinates. If the WGS 72 coordinates were transformed from original local datum coordinates, then a direct local datum to WGS 84 transformation is more accurate.

NAD 83 to WGS 84

These two datums are considered the same. The GRS 80 is the reference ellipsoid for NAD 83. It was

developed before WGS 84 and was a factor in upgrading WGS 72. When developing WGS 84, three of the system's four defining parameters were made identical to the parameters used for GRS 80. The only difference was the gravity model. The two datums are considered identical in all areas covered by NAD 83 except for the Aleutian Islands and Hawaii where a datum transformation is necessary.

Multiple Regression Equations

Multiple regression equations (MRE) were developed to deal with distortion on local datums. Datum shifts were created to reflect regional variations within the coverage area. This method is considered more

accurate than the seven and five parameter models, usually 1 to 3 meters.

Lateral Shift Method

When transforming between datums referenced to the same ellipsoid, a constant shift ($\Delta\phi$, $\Delta\lambda$) can be determined that is adequate for artillery survey applications over a small area. For example, both NAD 27 and Puerto Rico datums are referenced to the Clarke 1866 ellipsoid. A shift in latitude and longitude can be computed over stations common to both datums, then applied to stations that need to be transformed. The lateral shift method produces accurate data for the entire island of Vieques, Puerto Rico.

SECTION II. COORDINATE SYSTEMS

Three-Dimensional Positioning

The location of a point on the surface of the Earth is generally represented by coordinates. A coordinate system is a three-dimensional positioning system represented by a set of three quantities, each corresponding to angles or distances from a specified origin. The origin is generally either the center or the surface of a reference ellipsoid. Three-dimensional coordinates should not be confused with plane coordinates that are two-dimensional and are usually related to a grid system.

Cartesian Coordinates System

Cartesian coordinates identify the location of a unique three-dimensional (x,y,z) position in space. The system consists of the origin and three coordinate planes. See figure 3-13.

The origin is the intersection point of the three coordinate planes and is located at the center of the

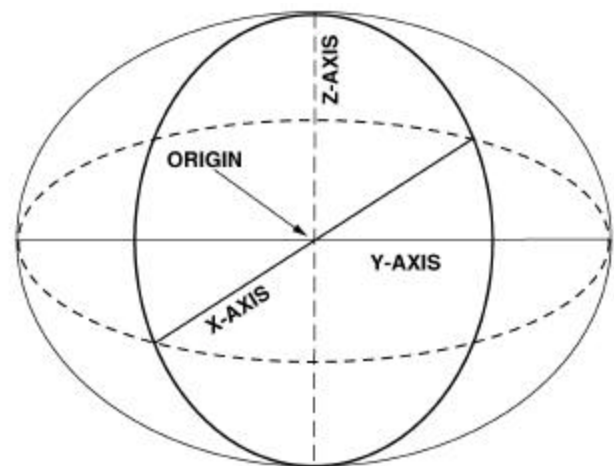

Figure 3-13. Coordinate Planes.

reference ellipsoid. When the origin is also located at the center mass of the Earth, it is considered geocentric.

The three mutually perpendicular coordinate planes intersect in three straight lines called coordinate axes. The axes intersect at right angles at the origin.

The x-axis lies on the equatorial plane of the reference ellipsoid at the intersection of the equatorial plane and the plane containing the prime meridian. It is

perpendicular to the plane containing the y- and z-axes. The x-axis is positive from the origin to the prime meridian.

The y-axis lies on the equatorial plane of the reference ellipsoid, perpendicular to the x-axis. It is perpendicular to the plane containing the x- and z-axes. The y-axis is positive east of the prime meridian.

The z-axis corresponds to the rotational axis of the reference ellipsoid (semi-minor axis). It lies perpendicular to the plane containing the x- and y-axes. The z-axis is positive from the origin to the North Pole.

The position of a point on the Earth's surface is described in terms of x, y, and z coordinates. These coordinates are distances, usually in meters, from the plane formed by two axes to the point along a line that is perpendicular to the plane and parallel to the third axis. See figure 3-14.

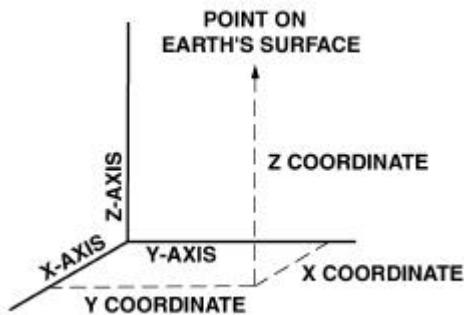

Figure 3-14. Cartesian Coordinates.

An x coordinate is the length of a line in the x-y plane that is parallel to the x-axis and measured from the y-z plane.

A-y coordinate is the length of a line in the x-y plane that is parallel to the y-axis and measured from the x-z plane.

A-z coordinate is the length of a line that is parallel to the z-axis and is measured from the intersection of the x coordinate and the y coordinate to a point on the surface of the Earth. The coordinates of the origin are (0,0,0).

Geographic Coordinates

Geographic coordinates are any three-dimensional coordinate system that specifies the position of a point on the surface of the Earth in terms of latitude (ϕ), longitude (λ), and ellipsoid height (h). It is an inclusive term that describes geodetic and astronomic positions. See figure 3-15.

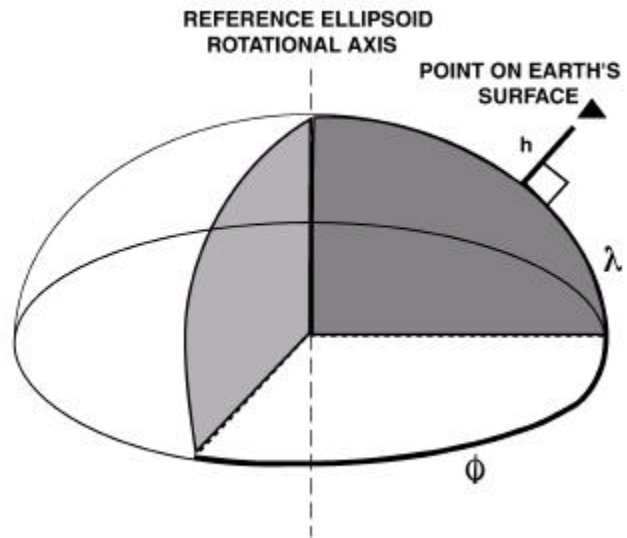

Figure 3-15. Geographic Coordinates.

Latitude and longitude are generally represented in degrees or degrees, minutes, and seconds along with a cardinal direction corresponding to a hemisphere on the Earth. A position will never have more than 60 minutes in a degree and never more than 60 seconds in a minute.

Latitude lines are called parallels of latitude. Latitude originates at the Equator at 0° . It increases toward the North and South Poles to 90° . It is labeled N or + for positions in the northern hemisphere; S or - for positions in the southern hemisphere; i.e. 34°N , $+34^\circ$, 34°S , -34° . See figure 3-16.

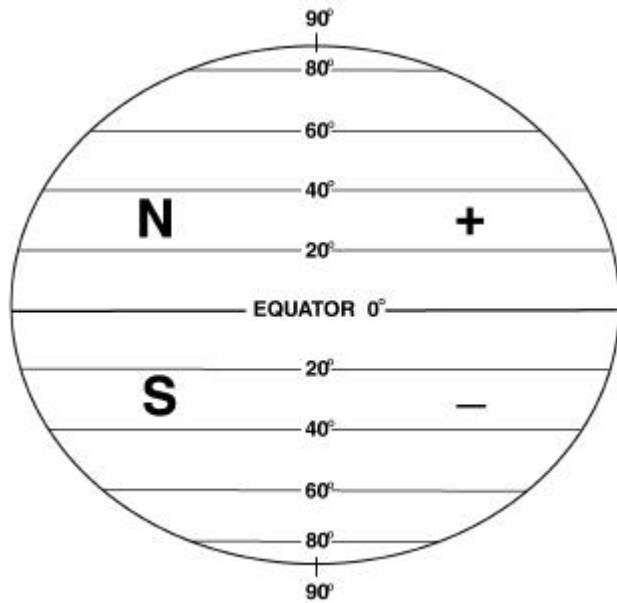

Figure 3-16. Parallels of Latitude.

Longitude lines are called meridians of longitude. Longitude originates with 0° at the Greenwich Meridian for most geographic systems; however, some systems reference other meridians as the 0° origin or prime meridian. Longitude increases east and west toward the International Dateline at 180°. In the eastern hemisphere, longitude is labeled E or +; in the western hemisphere, it is labeled W or -. For example, 107°E, +107°, 107°W, -107°. In some cases, the position of a point may include a longitude in excess of 180° E. These are converted to the standard format by subtracting the longitude from 360° e.g., 206°E = 154°W. The North and South Poles do not have a longitude. See figure 3-17.

A network of lines on a map representing parallels of latitude and meridians of longitude is called a graticule. A graticule can represent the entire globe or a small region of the Earth. See figure 3-18.

The inclination of two meridians toward each other is called convergence of the meridians, or more commonly convergence. All meridians of longitude are parallel at the Equator and intersect at the poles. Convergence of the meridians at the Equator is 0°. At the poles, the convergence equals the difference

between the longitude values of the meridians. Between the Equator and the poles, the convergence varies from 0° to the difference in the longitude values. Because of this, a geodetic azimuth and its back azimuth will differ by the convergence.

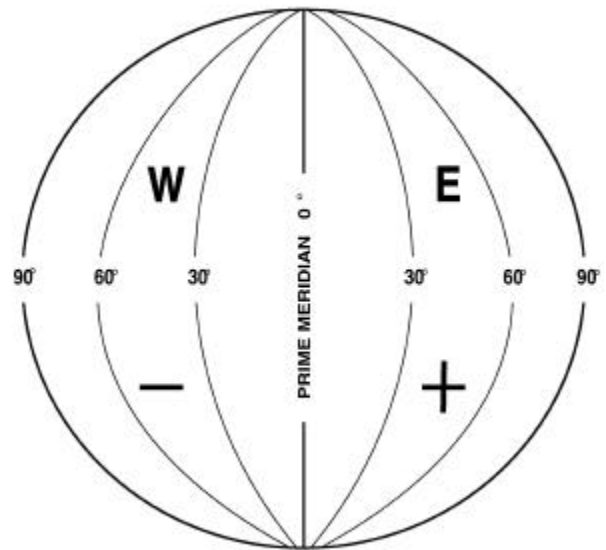

Figure 3-17. Meridians of Longitude.

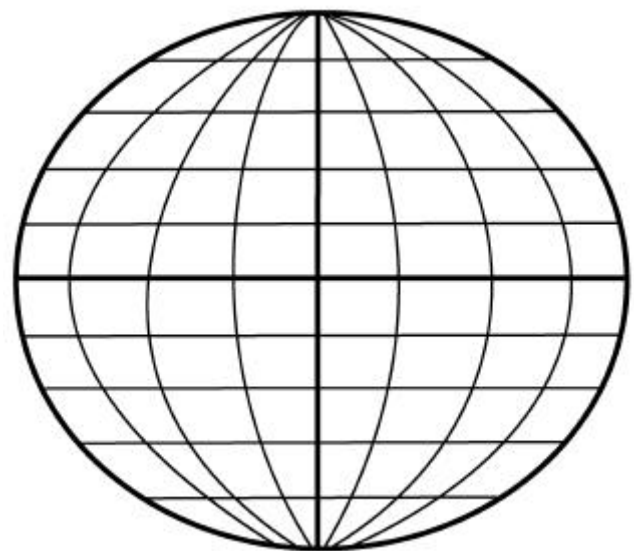

Figure 3-18. Graticule.

Geodetic Coordinates

Geodetic coordinates are the quantities of latitude (ϕ), longitude (λ), and ellipsoid height (H) that define the position of a point on the Earth's surface with respect to the reference ellipsoid. This type of geographic coordinate is the most commonly used by surveyors and cartographers. If the reference ellipsoid is geocentric; i.e., WGS 84, coordinates are termed geocentric geodetic coordinates.

The geodetic longitude of a point on the Earth's surface is the angle formed by the intersection of the plane containing the prime meridian (x - z cartesian plane) and the meridional plane containing the point. The geodetic latitude of a point is the angle formed by the intersection of the equatorial plane (x - y cartesian plane) and a line that passes through the point and is perpendicular to the reference ellipsoid. See figure 3-19.

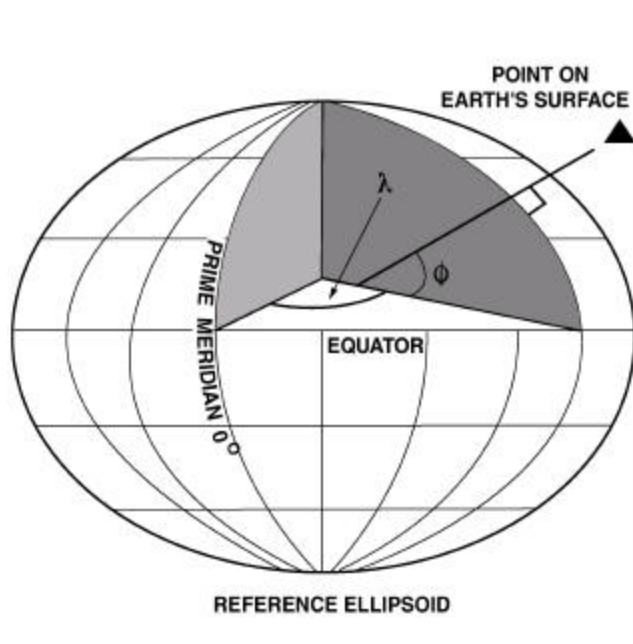

Figure 3-19. Geodetic Coordinates.

Geodetic coordinates are computed and adjusted as part of a geodetic network. All the points in the network are common to all the other points in that network. They are also common to points extending and adjusted from that network. Geodetic networks can be adjusted together to complete a national network such as the National Geodetic Reference System (NGRS) in the United States.

Astronomic Coordinates

Astronomic coordinates are those values that define the position of a point on the surface of the Earth or the geoid and reference the local direction of gravity. Astronomic coordinates can also refer to the location of a celestial body. Astronomic positions often establish and define horizontal datums. An ellipsoid is oriented so that a line through a point perpendicular to the geoid (vertical) is also perpendicular to the ellipsoid (normal). The geoid separation is generally zero at that point. At that point, the geodetic and astronomic coordinates are the same.

Astronomic latitude is the angle formed by the intersection of the plane of the celestial equator and the plumb line (perpendicular to the geoid). It equals the angle formed by the plane of the observer's horizon and the rotational axis of the Earth. Astronomic latitude results directly from observations of celestial bodies, uncorrected for the deflection of the vertical. The term applies only to the position of points on the Earth. Astronomic longitude is the time that elapses from the moment the celestial body is over the Greenwich Meridian until it crosses the observer's meridian. It results directly from observations of celestial bodies, uncorrected for the deflection of the vertical. See figure 3-20.

Astronomic coordinates are computed independent of each other. They can be connected by geodetic methods and adjusted to a geodetic network.

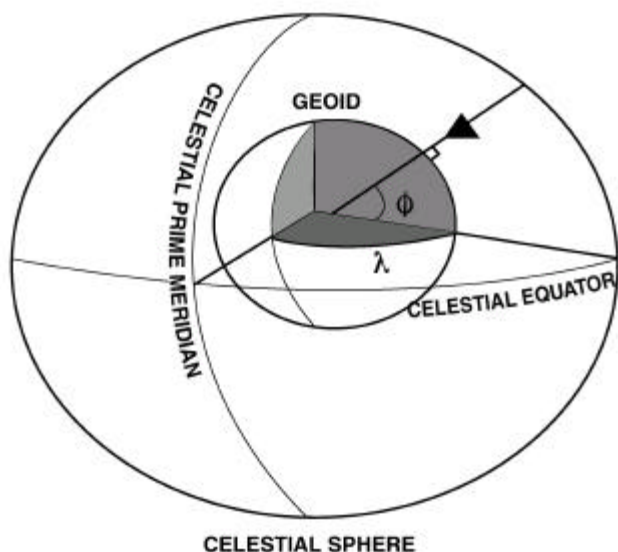

Figure 3-20. Astronomic Coordinates.

The Prime Meridian

The prime meridian is the meridian of longitude referenced as 0° for a particular geographic system. Usually, the term prime meridian is the Greenwich Meridian. However, figure 3-21 lists several systems using other meridians of longitude as the prime meridian for that system. Whenever survey data is provided in a system not referencing the Greenwich Meridian as 0° longitude, a simple conversion can be made by applying the longitude offset to the survey data longitude.

Angular Measurements

Care must be taken to ensure that if survey data is provided covering other nations, including mapping

Amsterdam, Netherlands Reformed Church, West Tower	$4^\circ 53' 01''$ E
Athens, Greece Observatory, Geodetic Pillar	$23^\circ 42' 59''$ E
Batavia (Djakarta), Indonesia Old Tidal Guage	$106^\circ 48' 28''$ E
Bern, Switzerland Old Observatory	$7^\circ 26' 22''$ E
Brussels, Belgium Observatory	$4^\circ 22' 06''$ E
Copenhagen, Denmark New Observatory	$12^\circ 34' 40''$ E
Ferro, Canary Islands (By definition 20° west of Paris)	$17^\circ 39' 46''$ W
Helsinki, Finland Observatory	$24^\circ 57' 17''$ E
Istanbul, Turkey Hagia Sophia	$28^\circ 58' 50''$ E
Lisbon Portugal Castelo San Jorge, Observatory	$9^\circ 07' 55''$ W
Madrid, Spain Observatory	$3^\circ 41' 15''$ W
Oslo, Norway Observatory	$10^\circ 43' 23''$ E
Paris, France Observatory	$2^\circ 20' 14''$ E
Pulkovo, Russia (USSR) Observatory	$30^\circ 19' 39''$ E
Rome, Italy Monte Mario	$12^\circ 27' 08''$ E
Stockholm, Sweden Observatory	$18^\circ 03' 30''$ E
Tirane, Albania First-Order Trig Point	$19^\circ 46' 45''$ E

Figure 3-21. Astronomic Longitudes of Prime Meridians.

products, that the data is shown or measured in the correct angular system. Two angular systems show coordinate systems on maps and to coordinate survey points: centesimal and sexagesimal.

The unit usually associated with a centesimal system is the grad (used extensively in Europe and North Africa). A grad is the hundredth part (1/100th) of a right angle. One grad equals 100 minutes; 1 minute equals 100 seconds. Grads are notated by g ; centesimal minutes by c ; and centesimal seconds by cc . The entire number is notated together like $12^g 8^c 27^{cc}$.

The unit usually associated with a sexagesimal system is the degree. A degree is the ninetieth part (1/90th) of a right angle. One degree equals 60 minutes; 1 minute equals 60 seconds. Degrees are notated by the symbol $^\circ$ e.g., 24° ; sexagesimal minutes by a $'$; e.g., $38'$; and sexagesimal seconds by a $''$; e.g., $02''$. The entire number is notated together like $24^\circ 38' 02''$.

Deflection of the Vertical

Deflection of the vertical at a point is the angular difference between the vertical (plumb line), which is perpendicular to the geoid, and a line through the point that is perpendicular to the reference ellipsoid. This term can be more accurately referred to as the astrogeodetic deflection of the vertical. See figure 3-22.

Due to the deflection of the vertical in the plane of the prime vertical (a circle in the east-west direction of the observer's horizon), there is a difference between astronomic and geodetic longitude and astronomic and geodetic azimuths. This is called the laplace condition and is expressed by the laplace equation. The laplace equation yields a correction, which when subtracted from an astronomic azimuth, will produce a geodetic azimuth.

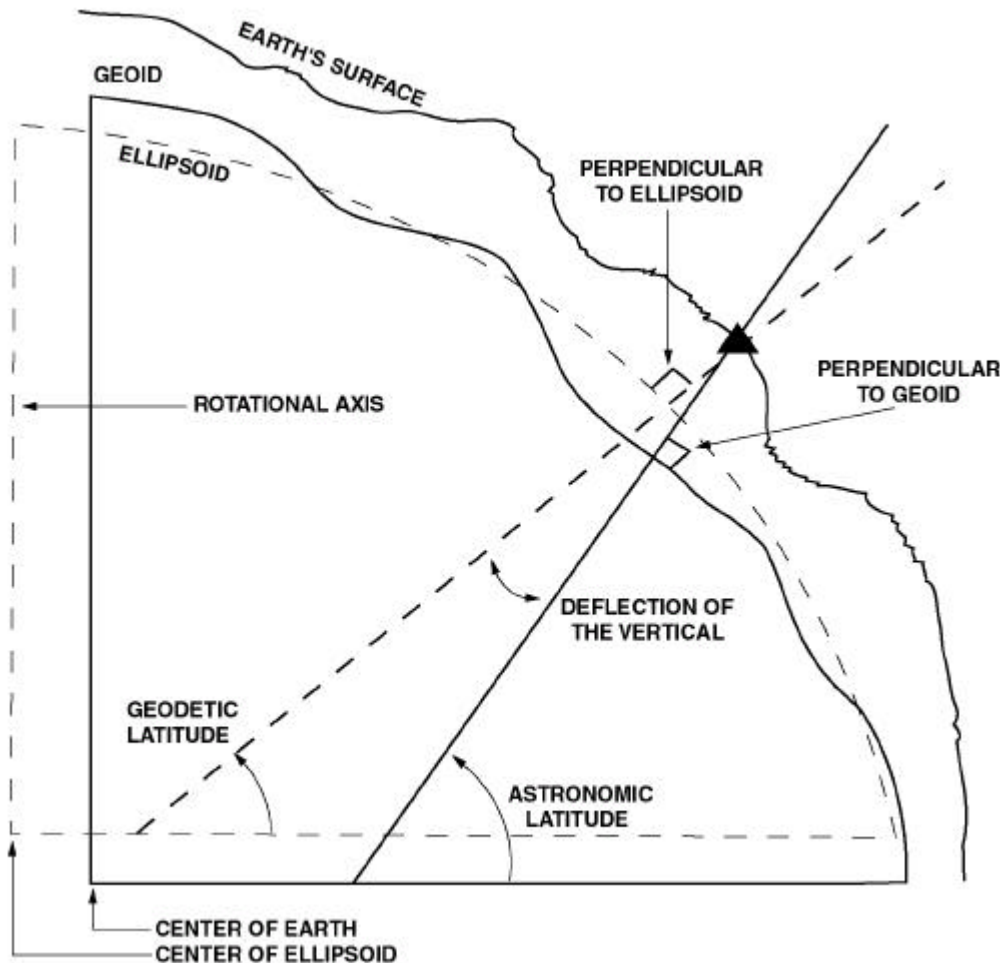

Figure 3-22. Deflection of the Vertical.

CHAPTER 4. MAP PROJECTIONS AND GRID SYSTEMS

SECTION I. MAP PROJECTIONS

A map projection is a method of representing a portion of the Earth's round surface on a flat surface. Because this procedure causes distortions of different types, many different projections have been developed. Each projection is dictated by the size of the area being mapped, the map scale, and the intended use of the maps. See table 4-2 at the end of this section.

Each projection preserves certain properties and distorts others. Most projections are cylindrical, conical or azimuthal, and project an ellipsoid onto cylinders, cones or plane surfaces. These surfaces may be tangent to the ellipsoid or they may be secant. A projection is tangent to the ellipsoid when only one point or line of the projection surface touches the ellipsoid. It is secant when two points or lines touch the ellipsoid. See figure 4-1.

One common characteristic applies to all United States military maps: they are all based on a conformal projection. A conformal map projection is one that at any point, the scale is the same in any direction and the angle between any two lines on the ellipsoid is the same when projected onto a plane.

Prescribed Projections

The Transverse Mercator (TM) Projection is the preferred projection for all military mapping, though it is not necessarily used on all military maps. The following projections are prescribed for U.S. military topographic maps and charts that display a military grid on a standard scale. Military maps of non-U.S.

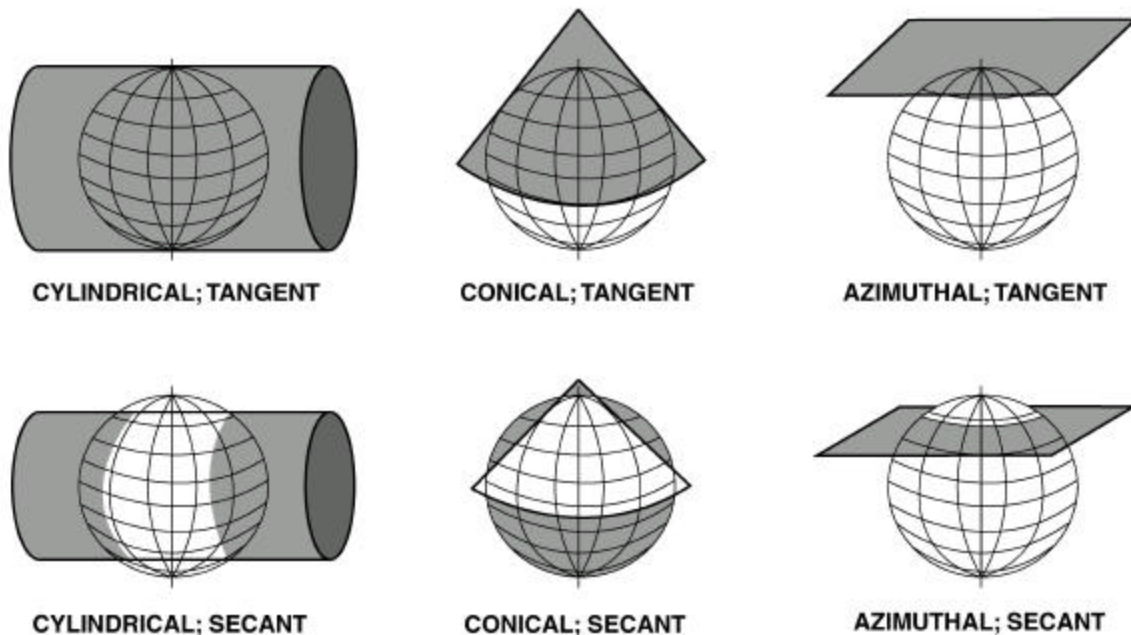

Figure 4-1. Projection Types: Tangent and Secant.

areas produced by other nations may not always conform to the following standards. U.S. maps of foreign areas may be based on other projections due to treaty agreements.

Topographic maps at scales of 1: 500,000 or larger that lie between 80°S latitude and 84°N latitude are based on the TM Projection.

Topographic maps at scales of 1: 1,000,000 that lie between 80°S latitude and 84°N latitude are based on the Lambert Conformal Conic Projection.

Maps at scales of 1: 1,000,000 or larger covering the polar regions (south of 80°S latitude and north of 84°N latitude) are based on the Polar Stereographic Projection.

Maps at scales smaller than 1: 1,000,000 are based on the projection best suited for the intended use of the map.

Scale Factor

For most military applications, map distance and ground distance are considered the same. However, for some geodetic and artillery operations (especially when long distances or high accuracies are involved), it is necessary to correct between map and ground distances.

A scale factor is necessary to compensate for distortions created when projecting an ellipsoidal surface onto a cylinder, cone or plane depending on the projection type. The scale factor of a projection is the ratio of arc length along a differentially small line in the plane of the projection to the arc length on the ellipsoid. This number depends on both the location of the point and on the direction of the line along which arc length is being measured. For conformal projections, the scale factor is independent of the direction of the line and depends only on the location of the point. The scale factor is labeled “k”.

The scale factor is considered exact (unity) when it has a value of 1. Unity occurs at the points of tangency or secancy between the ellipsoid and the projected surface. In a projection where the projected surface is tangent to an ellipsoid, the scale factor increases away

from the point of tangency. In a projection where the projected surface is secant to an ellipsoid, the scale factor decreases toward the central meridian or origin and increases away from the points of secancy.

True ground distance can be converted to a map distance by multiplying the ground distance by the scale factor.

Map Scale

A map scale is a representative ratio of map distances to ground distances. These ratios vary from map to map. The scale of a map is customarily chosen to correspond to the ratio at a given point or along a given line (if constant along that line) multiplied by a suitable scale factor (usually close to unity). It is usually expressed as a common fraction having one as a numerator and the integer closest to the actual ratio as a denominator.

Maps used by the military vary from small-scale planimetric maps showing all of the continents to large-scale topographic maps suitable for tactical operations of small units and fire control. Military maps are classified according to their scale.

Small-scale:	1: 600,000 and smaller
Medium Scale:	larger than 1: 600,000; smaller than 1: 75,000
Large Scale:	1: 75,000 and larger

Map scales can sometimes be confusing in the sense that the scale is smaller as the number increases. This confusion can be cleared by viewing the map scale as a fraction (1/100,000 is a smaller number than 1/50,000). The following are standard scales for military maps.

1: 1,000,000	1: 500,000
1: 250,000	1: 100,000
1: 50,000	1: 25,000

Mercator Projection

The Mercator Projection is a cylindrical projection where the rotational axis of the ellipsoid coincides with the axis of the cylinder so that the Equator is tangent to the cylinder. Points on the surface of the ellipsoid are projected onto the cylinder from the origin located on the equatorial plane and vary around three-quarters of the way back from the projected area. The cylinder is then opened and flattened to produce a plane surface. The parallels of latitude and meridians of longitude both appear as sets of parallel lines that intersect at right angles. The meridians are equally spaced, but the distance between parallels increases as their distance from the Equator increases. The poles cannot be shown on this projection (the normal limits are from 80°N latitude to 80°S latitude). See figure 4-2 and figure 4-3.

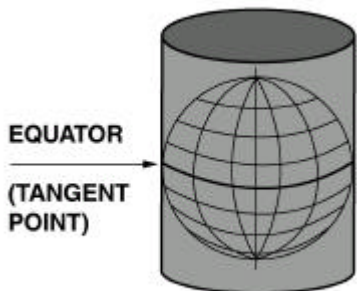

Figure 4-2. Mercator Projection.

As the distance from the Equator increases, so does the amount of distortion; e.g., the map scale at 60°N or S latitudes is nearly twice the map scale at the Equator. Maps or charts with this projection will distort the size of an area. This is why Alaska appears to be the same size as the lower 48 states. This projection is not commonly used for military purposes except when the entire Earth must be displayed and relative positions of land masses are more important than size and distance.

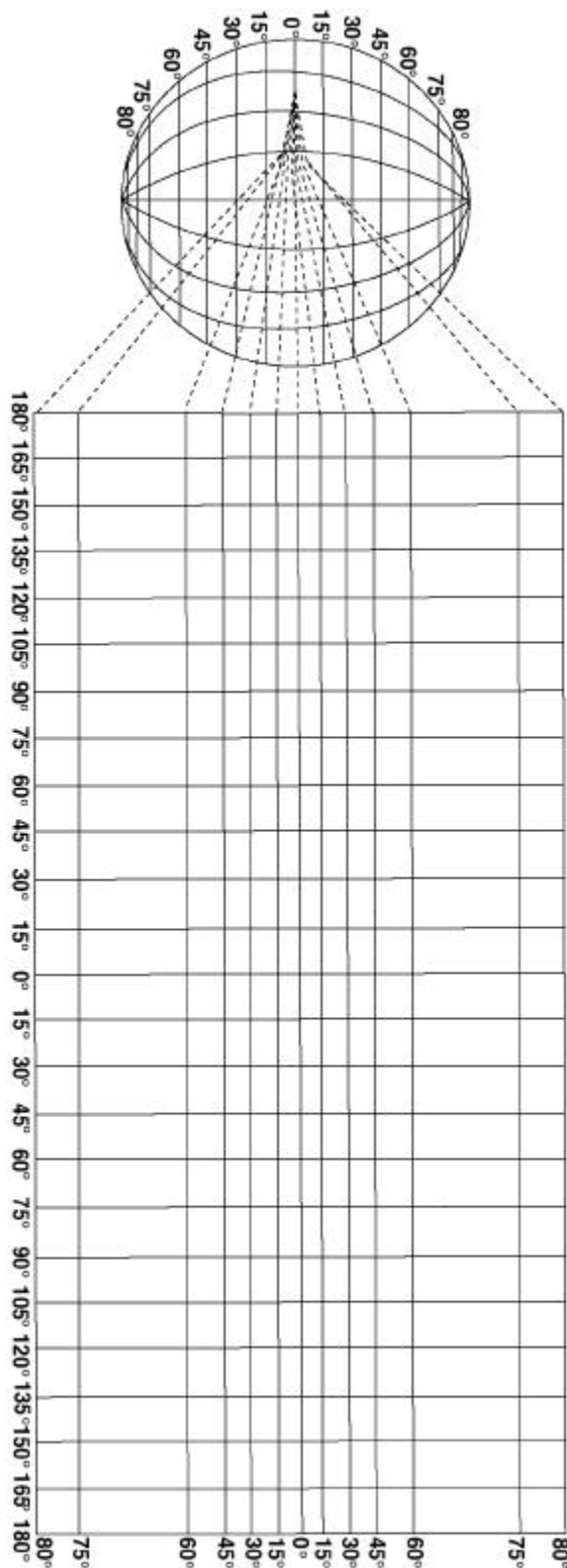

Figure 4-3. Mercator Projection Flattened onto a Plane.

Transverse Mercator Projection

The TM Projection is a cylindrical conformal projection. It is based on a modified Mercator Projection in that the cylinder is rotated (transverse) 90° so that the rotational axis of the ellipsoid is perpendicular to the axis of the cylinder. Generally, the TM Projection is considered as a cylinder that is secant to an ellipsoid. Only a six-degree wide portion of the ellipsoid is projected onto the cylinder. The centerline of the projected area is called the central meridian. The ellipsoid is then rotated six degrees inside the cylinder and another six degree portion is projected. See figure 4-4.

When the TM Projection is used to project a portion of the ellipsoid onto the cylinder, the Equator and the central meridian will appear as perpendicular straight lines. A hemisphere will be distorted towards its outer edges. The shaded areas of figure 4-5 show the varying distortion of two equivalent geographic areas on the same projection. Note that both areas encompass a region 20° by 20° and are both bounded by 20° and 40°N latitude. Therefore, on the ellipsoid they are the same size. But on the projected surface the area bounded by 60° and 80° longitude is much larger than the area bounded by 0° and 20° longitude. To decrease the amount of distortion, the ellipsoid is divided into 60 6°-wide projection zones, each with a meridian of longitude as its central meridian. Each zone is projected between 84° 30' N latitude and 80° 30' S latitude.

The cylinder used as the projection surface for the TM Projection is generally considered to be secant to the ellipsoid as shown in figure 4-4. This means that the cylinder intersects the ellipsoid in two places creating lines of secancy that are parallel to the central meridian of the projection. The lines of secancy are located 180,000 meters east and west of the central meridian of each projected zone. See figure 4-6.

Figure 4-7 shows a cross section of an ellipsoid and a cylinder of projection that is secant to the ellipsoid. The cross section is made by passing a plane through the ellipsoid at the Equator. Line A'M'D' represents the surface of the cylinder. Line AMD represents the projected portion of the ellipsoid surface. M is the central meridian; M' is the projection of the central

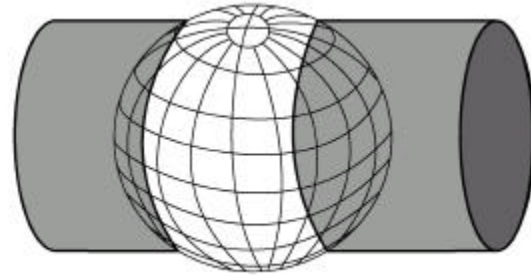

Figure 4-4. TM Projection.

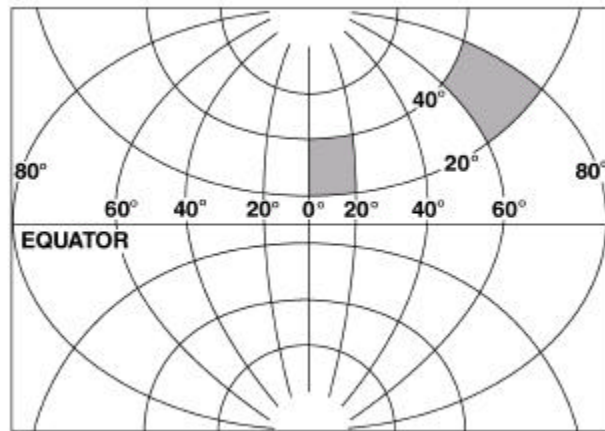

Figure 4-5. Distortion within the TM Projection.

meridian onto the cylinder. A and D are the meridians located three degrees from the central meridian. A' and D' are the projections of those meridians onto the cylinder. B and C are the points where the cylinder intersects the ellipsoid creating the secant condition. Note that line BM'C is shorter than line BMC. This shows that any line that lies between the lines of secancy is shorter on its projected plane (map) than it is on the ellipsoid surface. Note also that lines A'B and CD' are longer than lines AB and CD, respectively. This shows that any line that lies between the lines of secancy and the edges of the projection are longer on the projected plane than they are on the ellipsoid surface.

For the TM Projection, the scale factor at the lines of secancy is unity (1.000 or exact). The scale factor decreases toward the central meridian to 0.9996. The scale factor increases toward the zone limits to approximately 1.001 at the Equator. See figure 4-7 and table 4-1.

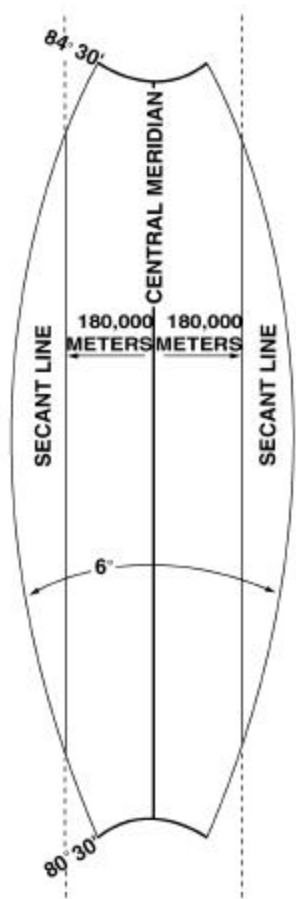

Table 4-1. TM Projection Scale Factor by UTM Easting.

Easting of Starting Station		Scale Factor (Meters)
500,000	500,000	0.99960
490,000	510,000	0.99961
480,000	520,000	0.99961
470,000	530,000	0.99961
460,000	540,000	0.99961
450,000	550,000	0.99963
440,000	560,000	0.99963
430,000	570,000	0.99966
420,000	580,000	0.99966
410,000	590,000	0.99970
400,000	600,000	0.99972
390,000	610,000	0.99975
380,000	620,000	0.99977
370,000	630,000	0.99982
360,000	640,000	0.99984
350,000	650,000	0.99985
340,000	660,000	0.99991
330,000	670,000	0.99995
320,000	680,000	1.00000
310,000	690,000	1.00005
300,000	700,000	1.00009
290,000	710,000	1.00014
280,000	720,000	1.00021
270,000	730,000	1.00025
260,000	740,000	1.00030
250,000	750,000	1.00037
240,000	760,000	1.00044
230,000	770,000	1.00051
220,000	780,000	1.00058
210,000	790,000	1.00064
200,000	800,000	1.00071
190,000	810,000	1.00078
180,000	820,000	1.00085
170,000	830,000	1.00094

Figure 4-6. Secancy in a 6° Zone.

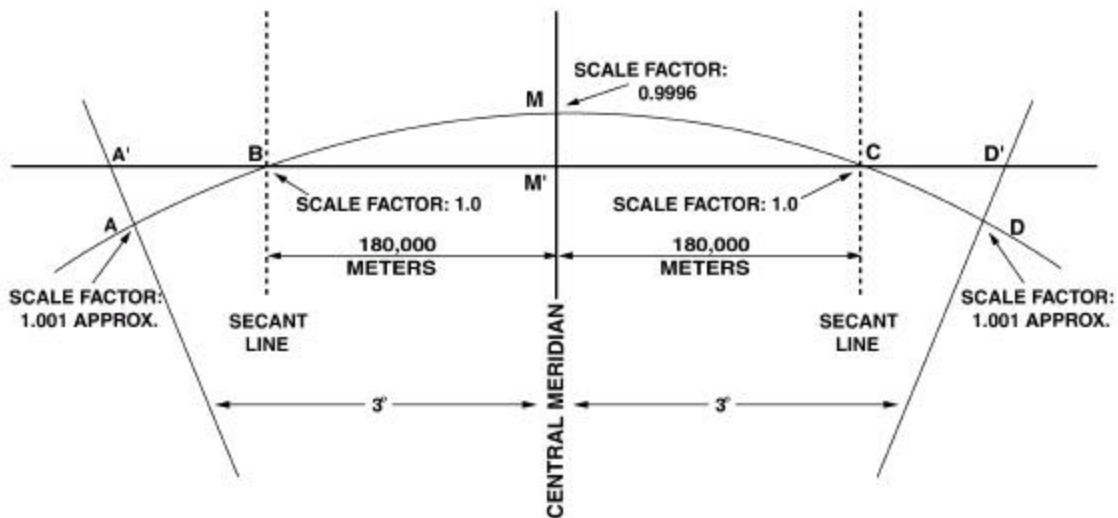

Figure 4-7. Line Distortion and Scale Factor in the TM Projection.

Gauss-Kruger Projection

The Gauss-Kruger (GK) Projection can be described as the TM Projection derived by mapping directly from an ellipsoid that is tangent to the cylinder. It is a conformal projection with many similarities to the TM Projection. The tangent point is the meridian of longitude chosen as the central meridian for the projection. As with TM, the GK Projection depicts 60 zones. Many geodesists consider the GK and TM Projections to be the same except for scale factor. See figure 4-8.

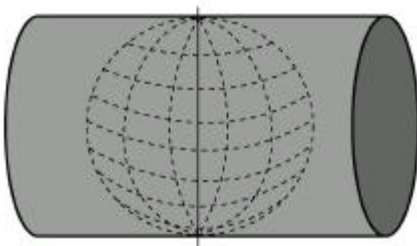

Figure 4-8. GK Projection.

When a meridian is tangent to a cylinder of projection, there is no distortion along that line. Figure 4-9 shows all lines not located on the central meridian are longer on the projected surface than they are on the ellipsoid. For example, line A'M is longer than line AM when A represents the meridian located three degrees from the central meridian. A' is the projection of that meridian onto a cylinder. M is the central meridian (tangent point).

For the GK Projection, the scale factor at the central meridian is unity (1.000 or exact). The factor increases outward toward the zone limits in excess of 1.004 at the Equator.

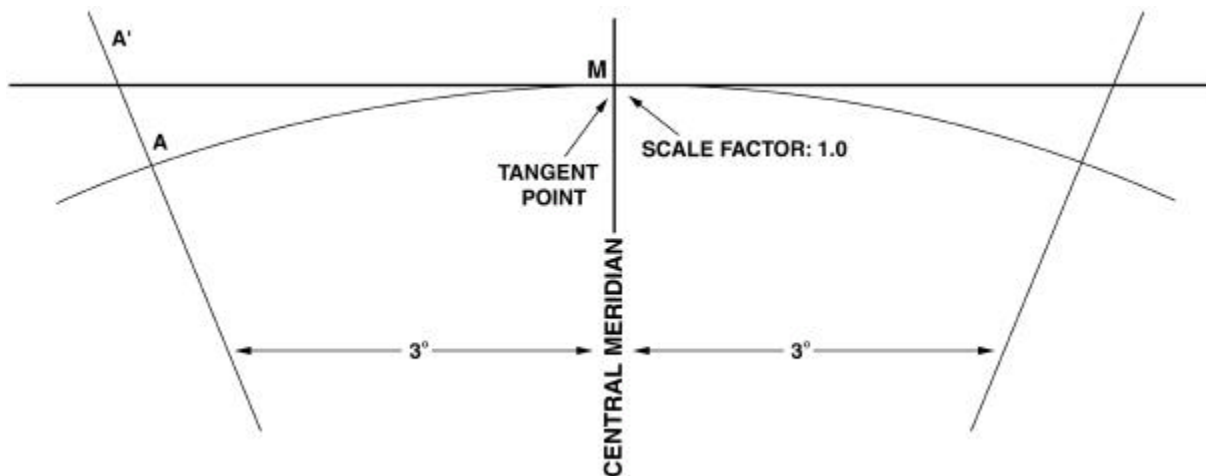

Figure 4-9. Line Distortion and Scale Factor in the GK Projection.

Polar Stereographic Projection

The Polar Stereographic Projection is used for mapping the Earth's polar regions and identifies those regions as north and south zones. The north zone extends from the North Pole to $83^{\circ} 30'$ N latitude; the south zone extends from the South Pole to $79^{\circ} 30'$ S latitude. It is a conformal azimuthal projection that is developed by projecting a polar region onto a plane that is tangent to an ellipsoid at the pole or secant to the ellipsoid at a specific latitude. The plane is perpendicular to the polar axis. The origin of the projection is the opposite pole. Meridians are straight lines and parallels are concentric circles.

Lambert Conformal Conic Projections

Lambert Conformal Conic Projections are the most widely used projections for civilian cartographers and surveyors. Many nations use it for civil and military purposes. This projection can be visualized as the projection of an ellipsoid onto a cone that is either tangent or secant to the ellipsoid. The apex of the cone is centered in the extension of the polar axis of the ellipsoid. A cone that is tangent to an ellipsoid is one that touches the ellipsoid at one parallel of latitude. A secant cone intersects the ellipsoid at two parallels called standard parallels. This text discusses the secant condition. See figure 4-10.

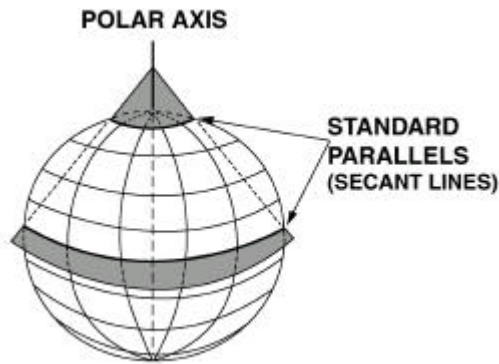

Figure 4-10. Secant Condition of Lambert Conformal Conic Projection.

When the cone of projection is flattened into a plane, meridians appear as straight lines radiating from a point beyond the mapped areas. Parallels appear as arcs of concentric circles centered at the point from where the meridians radiate. None of the parallels appears in exactly the projected positions. They are mathematically adjusted to produce the property of conformality. This projection is also called the Lambert Conformal Orthomorphic Projection. See figure 4-11.

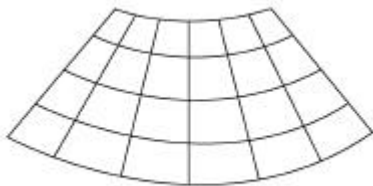

Figure 4-11. Cone Flattened onto a Plane.

The parallels of latitude on the ellipsoid that are to be secant to the cone are chosen by the cartographer. The distance between the secant lines is based on the purpose and scale of the map. For example, a USGS map showing the 48 contiguous states uses standard parallels located at 33°N and 45°N latitudes (12° between secant lines). Aeronautic charts of Alaska use 55°N and 65°N (10° between secant lines). For the National Atlas of Canada, secant lines are 49°N and 77°N (28° between secants). The standard parallels for USGS maps in the 7.5 and 15-minute series vary from state to state. Several states are separated into two or more zones with two or more sets of standard parallels. See figure 4-12 on page 4-8.

Since this is a conformal projection, distortion is comparable to that of the TM and Polar Stereographic Projections. Distances are true along the standard parallels and reasonably accurate elsewhere in limited regions.

Directions are fairly accurate over the entire projection. Shapes usually remain relative to scale but the distortion increases away from the standard parallels. Shapes on large-scale maps of small areas are essentially true. Scale factor is exact (unity or 1.000) at the standard parallels. It decreases between and increases away from the standard parallels. The exact number depends on the distance between the standard parallels.

Oblique Mercator Projection

The Oblique Mercator Projection is actually many different projections using variations of the TM. All are cylindrical and conformal. But instead of the cylinder being transverse 90° from the Mercator Projection, it is transverse at an angle that places the long axis of the cylinder 90° from the long axis of the area being mapped. If the general direction of an area that is to be mapped lies in a northeast/southwest attitude, the cylinder of projection would be transverse 45° west of north. The cylinder is usually secant to the ellipsoid to lessen the effects of distortion. The location of the lines of secancy varies between projections. Many Oblique Mercator Projections exist. This publication discusses the Laborde Projection and the West Malaysia Rectified Skew Orthomorphic (RSO) Projection only.

The Laborde Projection is used to map the island of Madagascar. It is an Oblique Mercator type projection with the long axis of the cylinder oriented at 18° 54' east of north. Scale factor at the origin is 0.9995. This projection is used with the International Ellipsoid.

The West Malaysia RSO Projection is used to map the islands of Malaysia. It is an Oblique Mercator type projection with the long axis of the cylinder oriented at 36° 58' 27.1542" east of north. Scale factor at the origin is 0.99984. This projection is used with the Modified Everest Ellipsoid to map the West Malaysia RSO Grid System.

Many other Oblique Mercator Projections are used to map areas of the world. Most are designed to work with a specific grid system like the West Malaysia system described above. Examples of these systems include but are not limited to—

- Alaska Zone 1 RSO.
- Borneo RSO.
- Great Lakes (4 Zones) RSO.

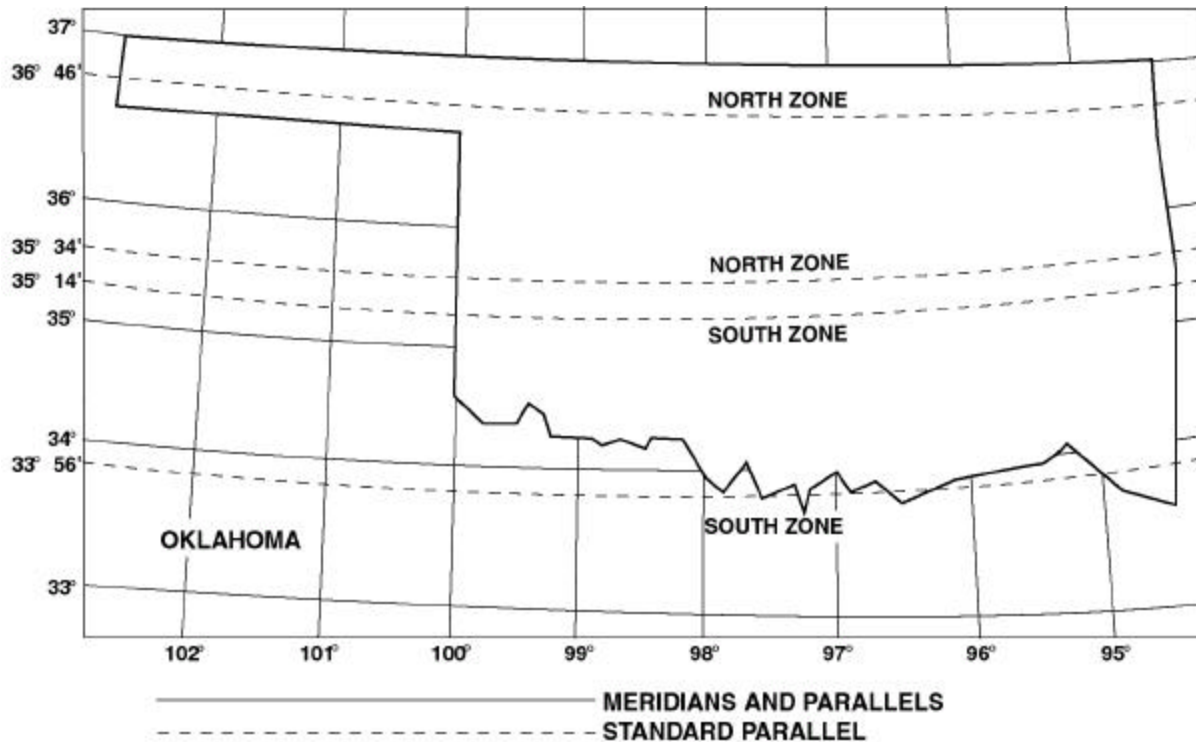

Figure 4-12. Oklahoma Lambert Projection; North and South Zones.

- Liberia RSO.
- Malaya (chain) RSO.
- Malaya (yard) RSO.
- Switzerland Oblique Mercator.

New Zealand Map Grid Projection

The New Zealand Map Grid (NZMG) Projection is used to map New Zealand. It is a sixth-order complex-algebra polynomial modification of the Mercator Projection. A cylinder cannot necessarily be considered in this projection. It is a mathematical projection set secant to the International Ellipsoid. The NZMG has no defined scale factor at the central meridian. Scale factor ranges from 1.00023 to 0.00078 over the entire projection.

Cassini Projection

The Cassini Projection can be viewed outwardly as a GK projection in that the cylinder is transverse 90° from the Mercator Projection. It is also tangent to the ellipsoid at the

central meridian of a zone. The Cassini Projection predates the GK and TM Projections. It is made by treating all meridians as planes that extend from the ellipsoid out to the cylinder. This projection causes the Equator and central meridian to be perpendicular straight lines. All other meridians appear as lines that intersect the Equator at right angles and curve toward the central meridian except for those meridians that are located 90° from the central meridian. Those meridians appear as straight lines that are parallel to the Equator. Scale factor at the central meridian is unity (1.00 or exact). This projection is still used in some areas for civil and local grid systems, but is considered obsolete for most purposes. In many areas it has been replaced by the TM Projection. This projection is sometimes called the Cassini-Solder Projection.

Position differences between Cassini grid systems and TM grid systems are slight. For example, northing is the same in the Palestine Cassini Civil Grid as it is in the Palestine TM Civil Grid. The easting difference between the two is zero at 20 kilometers from the central meridian and only 4.1 meters at 100 kilometers from the central meridian.

Table 4-2. Projection Features.





CHARACTERISTICS	MERCATOR	TRANSVERSE MERCATOR	OBLIQUE MERCATOR
PARALLELS	PARALLEL STRAIGHT LINES UNEQUALLY SPACED	CURVES CONCAVE TOWARD NEAREST POLE	SINE LINES
MERIDIANS	PARALLEL STRAIGHT LINES EQUALLY SPACED	COMPLEX CURVES CONCAVE TOWARD CENTRAL MERIDIAN	CURVED LINES
APPEARANCE OF PROJECTION			
ANGLE BETWEEN PARALLELS & MERIDIANS	90°	90°	90°
STRAIGHT LINE CROSSES MERIDIANS	CONSTANT ANGLE (RHUMB LINE)	VARIABLE ANGLE	VARIABLE ANGLE
GREAT CIRCLE	CURVED LINE (EXCEPT EQUATOR AND MERIDIANS)	CURVED LINE	
RHUMB LINE	STRAIGHT LINE	CURVED LINE	CURVED LINE
DISTANCE SCALE	MID- LATITUDE		
GRAPHIC ILLUSTRATION	CYLINDER TANGENT AT EQUATOR 	CYLINDER TANGENT AT CENTRAL MERIDIAN FOR GK GRID; SECANT AT CENTRAL MERIDIAN FOR UTM GRID. 	CYLINDER CAN BE TANGENT OR SECANT; DEPENDANT ON THE USE. 
ORIGIN OF PROJECTORS	CENTER OF SPHERE (FOR ILLUSTRATION ONLY)	CENTER OF SPHERE (FOR ILLUSTRATION ONLY)	CENTER OF SPHERE (FOR ILLUSTRATION ONLY)
DISTORTION OF SHAPES AND AREAS	INCREASES AWAY FROM EQUATOR	INCREASES AWAY FROM MERIDIAN OF TRUE SCALE	INCREASES AWAY FROM GREAT CIRCLE OF TRUE SCALE
METHOD OF PRODUCTION	MATHEMATICAL	MATHEMATICAL	MATHEMATICAL
NAVIGATIONAL USES	DEAD RECKONING AND CELESTIAL (SUITABLE FOR ALL TYPES)	GRID NAVIGATION	CHARTS OF GREAT CIRCLE PATHS
CONFORMAL	YES	YES	YES

Table 4-2. Projection Features (Continued).



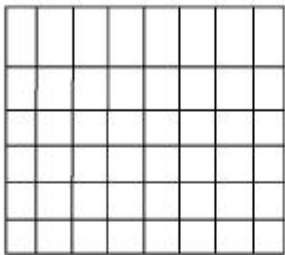
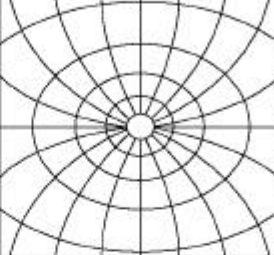
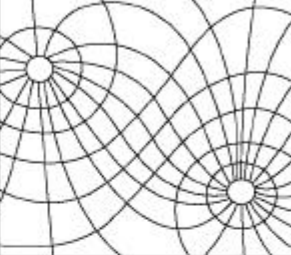

CHARACTERISTICS	GNOMONIC	POLAR GNOMONIC	POLAR STEREOGRAPHIC
PARALLELS	CONIC SECTIONS (CURVED LINES)	CONCENTRIC CIRCLES UNEQUALLY SPACED	CONCENTRIC CIRCLES UNEQUALLY SPACED
MERIDIANS	STRAIGHT LINES	STRAIGHT LINES RADIATING FROM THE POLES	STRAIGHT LINES RADIATING FROM THE POLES
APPEARANCE OF PROJECTION			
ANGLE BETWEEN PARALLELS & MERIDIANS	VARIABLE ANGLE	90°	90°
STRAIGHT LINE CROSSES MERIDIANS	VARIABLE ANGLE (GREAT CIRCLE)	VARIABLE ANGLE (GREAT CIRCLE)	VARIABLE ANGLE (APPROXIMATES GREAT CIRCLE)
GREAT CIRCLE	STRAIGHT LINE	STRAIGHT LINE	APPROXIMATED BY STRAIGHT LINE
RHUMB LINE	CURVED LINE	CURVED LINE	CURVED LINE
DISTANCE SCALE			NEARLY CONSTANT EXCEPT ON SMALL SCALE CHARTS
GRAPHIC ILLUSTRATION			PLANE CAN BE TANGENT OR SECANT; DEPENDANT ON THE USE. 
ORIGIN OF PROJECTORS	CENTER OF SPHERE	CENTER OF SPHERE	OPPOSITE POLE
DISTORTION OF SHAPES AND AREAS	INCREASES AWAY FROM CENTER OF PROJECTION	INCREASES AWAY FROM POLE	DECREASES AWAY FROM POLE
METHOD OF PRODUCTION	GRAPHIC OR MATHEMATICAL	GRAPHIC OR MATHEMATICAL	GRAPHIC OR MATHEMATICAL
NAVIGATIONAL USES	GREAT CIRCLE NAVIGATION AND PLANNING	GREAT CIRCLE NAVIGATION AND PLANNING	POLAR NAVIGATION OF ALL TYPES
CONFORMAL	NO	NO	YES

Table 4-2. Projection Features (Continued).

CHARACTERISTICS	LAMBERT CONTROL	POLYCONIC	AZIMUTHAL EQUIDISTANT
PARALLELS	ARCS OF CONCENTRIC CIRCLES NEARLY EQUALLY SPACED	ARCS OF CIRCLES NOT CONCENTRIC	CURVED LINES
MERIDIANS	STRAIGHT LINES CONVERGING AT THE POLES	MID-MERIDIAN STRAIGHT ALL OTHERS CURVED	CURVED LINES
APPEARANCE OF PROJECTION			
ANGLE BETWEEN PARALLELS & MERIDIANS	90°	VARIABLE	VARIABLE ANGLE
STRAIGHT LINE CROSSES MERIDIANS	VARIABLE ANGLE (APPROXIMATES GREAT CIRCLE)	VARIABLE ANGLE	VARIABLE ANGLE
GREAT CIRCLE	APPROXIMATED BY STRAIGHT LINE	APPROXIMATELY STRAIGHT LINE NEAR MID-MERIDIAN	STRAIGHT LINES RADIATING FROM CENTER
RHUMB LINE	CURVED LINE	CURVED LINE	CURVED LINE
DISTANCE SCALE	NEARLY CONSTANT	VARIABLE FOR LARGE AREAS	TRUE AT ALL AZIMUTHS FROM CENTER ONLY
GRAPHIC ILLUSTRATION	SECANT CONE 		NO GEOMETRIC APPLICATION CAN BE SHOWN
ORIGIN OF PROJECTORS	CENTER OF SPHERE (FOR ILLUSTRATION ONLY)	CENTER OF SPHERE (FOR ILLUSTRATION ONLY)	
DISTORTION OF SHAPES AND AREAS	VERY LITTLE	INCREASES AWAY FROM MID-MERIDIAN	INCREASES AWAY FROM CENTER
METHOD OF PRODUCTION	MATHEMATICAL	MATHEMATICAL	MATHEMATICAL
NAVIGATIONAL USES	SUITABLE FOR ALL TYPES	NORTH-SOUTH STRIPMAPS	AERONAUTCS, RADIO ENGINEERING, AND CELESTIAL MAPS
CONFORMAL	YES	NO	NO

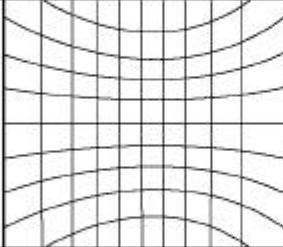
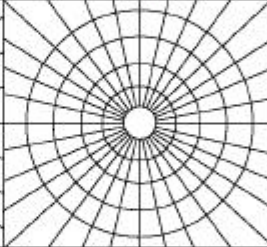
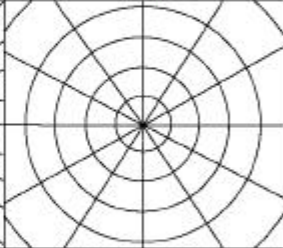
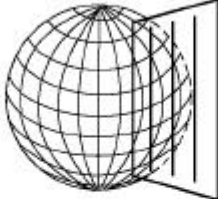
SECTION II. GRID SYSTEMS

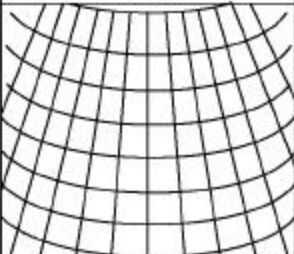
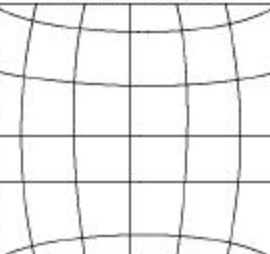
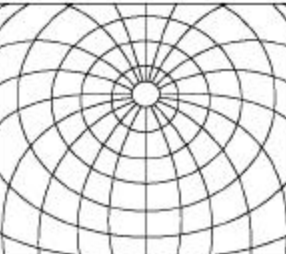
A grid system is a two-dimensional plane-rectangular coordinate system that is usually based on and mathematically adjusted to a map projection. This allows for the transformation from geodetic positions (latitude and longitude) to plane coordinates (easting and northing) and for the computations relating to those coordinates to be made by ordinary methods of plane surveying.

Many grid systems are in use. Most of the local systems will eventually be converted to one of the universal grid systems. Some areas will continue to be mapped in a local system such as the British National Grid (BNG), the Irish Transverse Mercator Grid (ITMG), and the Madagascar Grid (MG). There are two universal grids used by the United States military and its allies: UTM and Universal Polar Stereographic (UPS).

Grids consist of a system of evenly spaced parallel lines lying perpendicular to another system of evenly spaced parallel lines forming squares. The ground distance between the lines depends on the scale of the map and the type of grid system. Most systems use meters as a basis for grid line spacing. Others use yards or feet. Standard scale military maps generally adhere to grid lines on—

- Large-scale maps spaced at 1,000 meters.
- Medium-scale maps at 1:250,000 spaced at 10,000 meters.

For scales smaller than 1:250,000, the grid lines may or may not be depicted, depending on the map's purpose.

North-south lines in a grid system are called eastings and increase in value from west to east. East-west lines in a grid system are called northings and increase in values from south to north. (These rules do not apply to grid systems that cover the polar regions such as the UPS.) The numerical value of an easting and northing are referenced to a specific origin. A false value is applied to the easting or northing grid line that falls at a particular reference line or point. Usually, that line or point is a meridian of longitude; e.g., central meridian of a zone or a parallel of latitude (like the Equator, but it can have other references). The origin for the false easting and false northing are normally different lines or points.

Grid convergence is the angular difference between true north and grid north. The direction and the value of the angle are computed differently depending on the grid system. In some systems, grid convergence can be the same as convergence of the meridians.

Universal Transverse Mercator Grid System

The Universal Transverse Mercator (UTM) Grid System is referenced to the TM Projection. The ellipsoid is divided into 60 grid zones, each 6° wide, extending from 84° N latitude to 80° S latitude. Zones are numbered from 1 to 60. Zone 1 starts at 180° – 174° west longitude, zone 2 at 174° west – 168° west longitude, continuing east to zone 60 at 174° E – 180° longitude. The prime meridian (0° longitude) separates zones 30 and 31. See figure 4-13.

The location of any point in the UTM grid system can be designated by coordinates by giving its distance east-west (easting) and its distance north-south (northing) from the origin of the grid zone. This origin (for each UTM grid zone) is the intersection of the Equator and the central meridian of the zone. Each UTM zone has a central meridian corresponding to the central meridian of each TM Projection zone. The grid is oriented by placing the east-west axis of the grid in coincidence with the Equator and the north-south axis of the grid in coincidence with the central meridian of the zone.

Once the grid is oriented, the origin for easting and northing are assigned false values. The central meridian (origin for easting) of each zone is assigned an easting value of 500,000 meters. The easting increases east of the central meridian and decreases west. The Equator (origin for northing) is assigned two false values. If operating in the Northern Hemisphere, the northing of the Equator is 0 meters and increases north. If operating in the Southern Hemisphere, the northing of the Equator is 10,000,000 meters and decreases south. Grid lines that run north and south are easting lines. They are parallel to the central meridian of the grid zone. Grid lines that run east and west are northing lines. They are parallel to the Equator. See figure 4-14 on page 4-14.

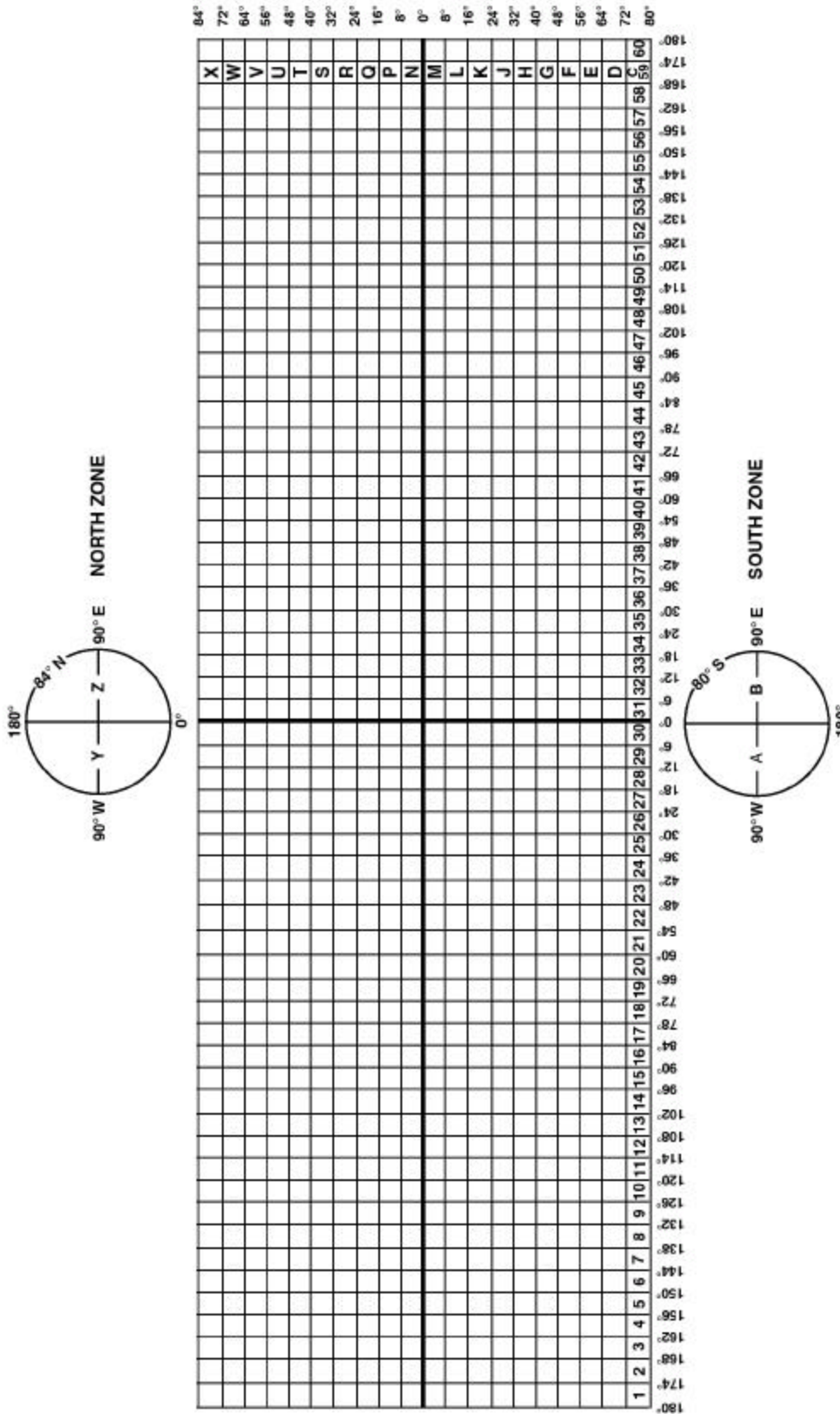

Figure 4-13. UTM/UPS Grid Zones and Grid Zone Designators.

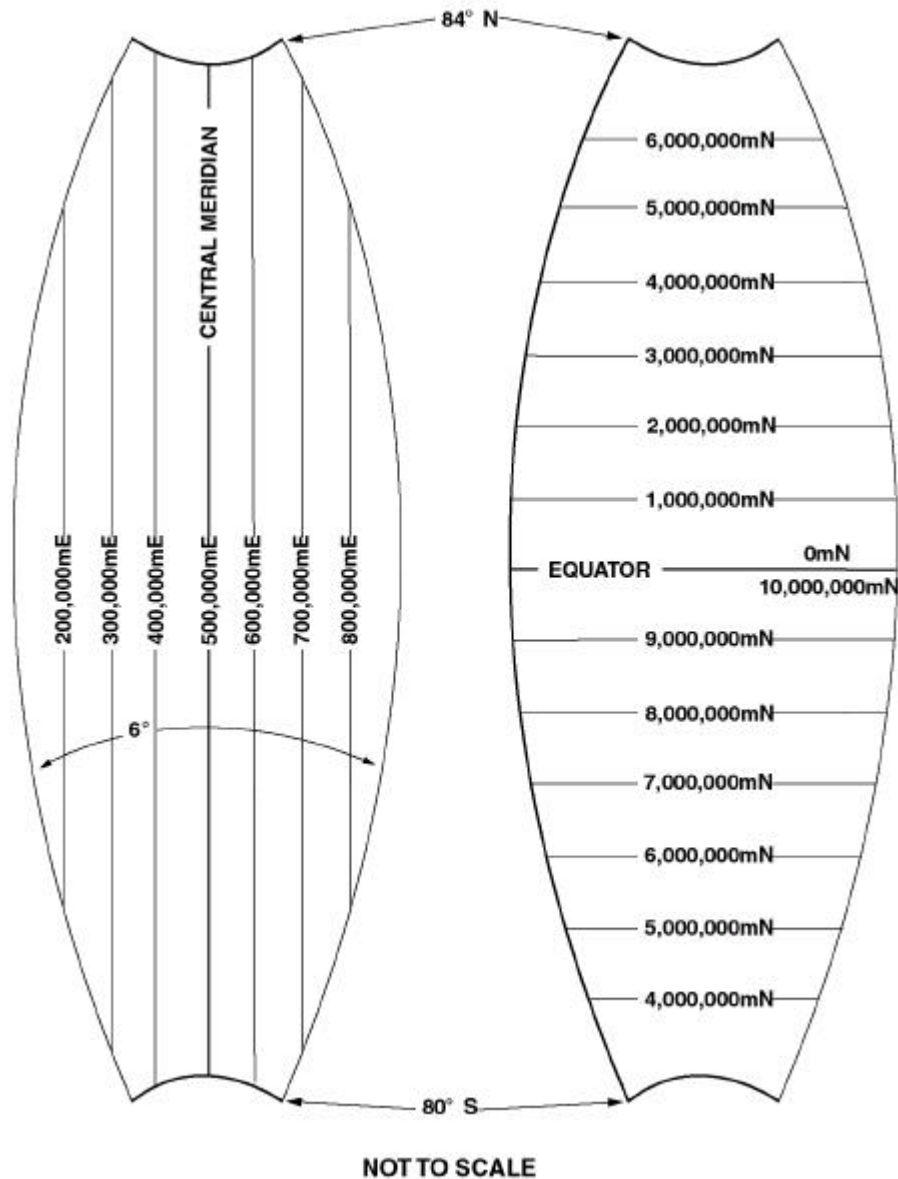

Figure 4-14. UTM Easting and Northing.

Grid convergence at a point in the UTM system is the angle measured, east or west, from true north to grid north. At any point along the central meridian of a UTM grid zone, true north and grid north are the same. At any point not located on the central meridian, grid north departs from true north because of convergence of the meridians. Grid convergence within the UTM system is a function of both latitude and longitude. It will rarely exceed 3° (53.333 mils) and is normally

listed in the declination diagram of a map. Grid convergence should be computed for use in fifth order or higher surveys because the information on the map is generally computed for the center of the map sheet. For example, the Lawton map sheet (6353III) lists the grid convergence at 6 mils, the Cache map sheet (6253II) lists it at 4 mils. There are two mils difference between the centers of these two adjoining sheets. See figure 4-15.

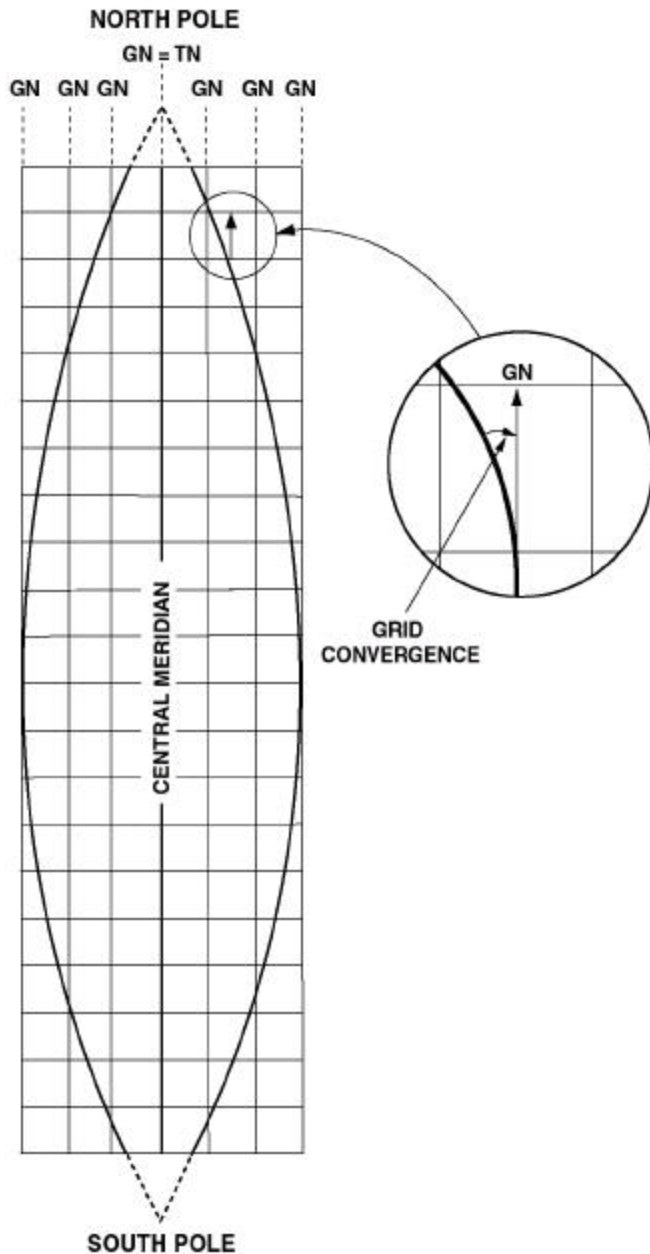

Figure 4-15. UTM Grid Convergence.

In the Northern Hemisphere, grid convergence is negative east of the central meridian and positive west. In the Southern Hemisphere, grid convergence is positive east of the central meridian and negative west. The direction (+, -) and the value of the grid convergence are applied to a true azimuth to obtain a grid azimuth. If a grid azimuth must be converted to a true azimuth, the value of the grid convergence

is the same. However, the opposite sign (direction) must be used. See figure 4-16.

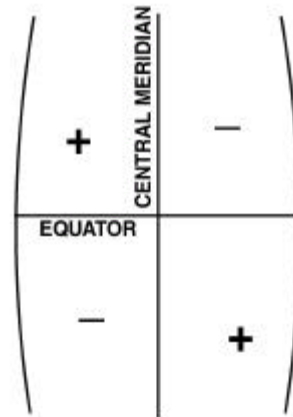

Figure 4-16. Sign of Grid Convergence.

The standard UTM grid zone is 6° wide. However, portions of several grid zones have been modified to accommodate southwest Norway and the islands of Svalbard. These grid zone modifications are not available in many survey or fire support systems. User-defined options or work-around methods must be used in these areas. Figure 4-17 on page 4-16 shows the nonstandard portions of the respective grid zones.

Easting and northing values of a point in the UTM grid system are called grid coordinates. Easting consists of six digits before the decimal point. The only exception is positions that are actually located in an adjacent grid zone. An easting can be written with the first digit (100,000 meters) separated from the next five with a space. Northing generally has seven digits before the decimal point. The exception to this is at locations north of the Equator by less than 1,000,000 meters. A northing can be written with the first two digits (1,100,000 meters) separated from the next five digits with a space. The number of digits after the decimal point depends on the order of survey and the accuracy needed. An example of a UTM grid coordinate is 6 39127.84 – 38 25411.24.

If at any time you cross the Equator from north to south (at which point you would have a negative northing), you must algebraically add the northing to ten million meters to obtain a northing for the Southern Hemisphere. If you cross the Equator from south to north (which would produce a northing

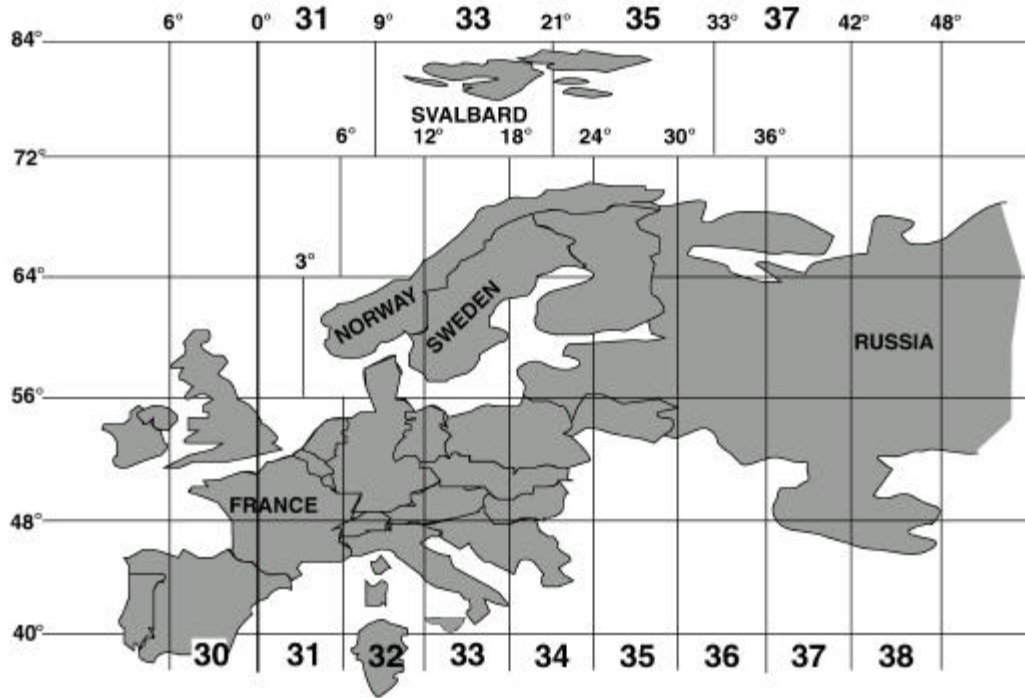

Figure 4-17. Nonstandard UTM Grid Zones.

greater than ten million meters), you must subtract ten million meters from your northing to obtain a northing that can be used in the Northern Hemisphere.

Military Grid Reference System

UTM, GK, and UPS grid coordinates are not unique. Any UTM grid coordinates can be plotted in each of the 60 grid zones. Many UTM and GK coordinates will plot in both the Northern and Southern Hemispheres of the same grid zone. All UPS grid coordinates between 84° and 90° north and south latitudes will plot in each of the two UPS grid zones. To make UTM and UPS grid coordinates unique, the grid zone and grid zone designator should accompany them.

The MGRS is designed for use with the UTM and UPS grid systems. It establishes a unique set of coordinates for each specific location on the Earth. An MGRS grid coordinate consists of a grid zone (UTM only), a grid zone designator, a 100,000-meter square identifier, and the easting/northing coordinate.

A grid zone designator is a one-letter code specifying a particular portion of a UTM/UPS grid zone. The grid zone designator is usually listed in the marginal data of a military map. See figure 4-18.

Each of the 60 UTM grid zones is divided into 20 grid zone designators. Each designator represents an 8° portion of the grid zone except the northernmost (represents 12°). Designators are identified alphabetically by the letters C to X with the letters I and O omitted. C is the southernmost designator, X is the northernmost, and the Equator separates M and N. Thus, a grid zone and grid zone designator together specify a region of the Earth covering a 6° by 8° area except in the northernmost designation X (specifies a 6° by 12° area).

Both UPS zones (north and south) are divided into two grid zone designations separated by the 0° and 180° meridians. In the north, the designator Y covers the Western Hemisphere; Z covers the Eastern Hemisphere. In the south, designator A covers the Western Hemisphere; B the Eastern Hemisphere. Since numbers are not used to identify UPS grid zones, a UPS grid MGRS coordinate will begin with the grid zone designator.

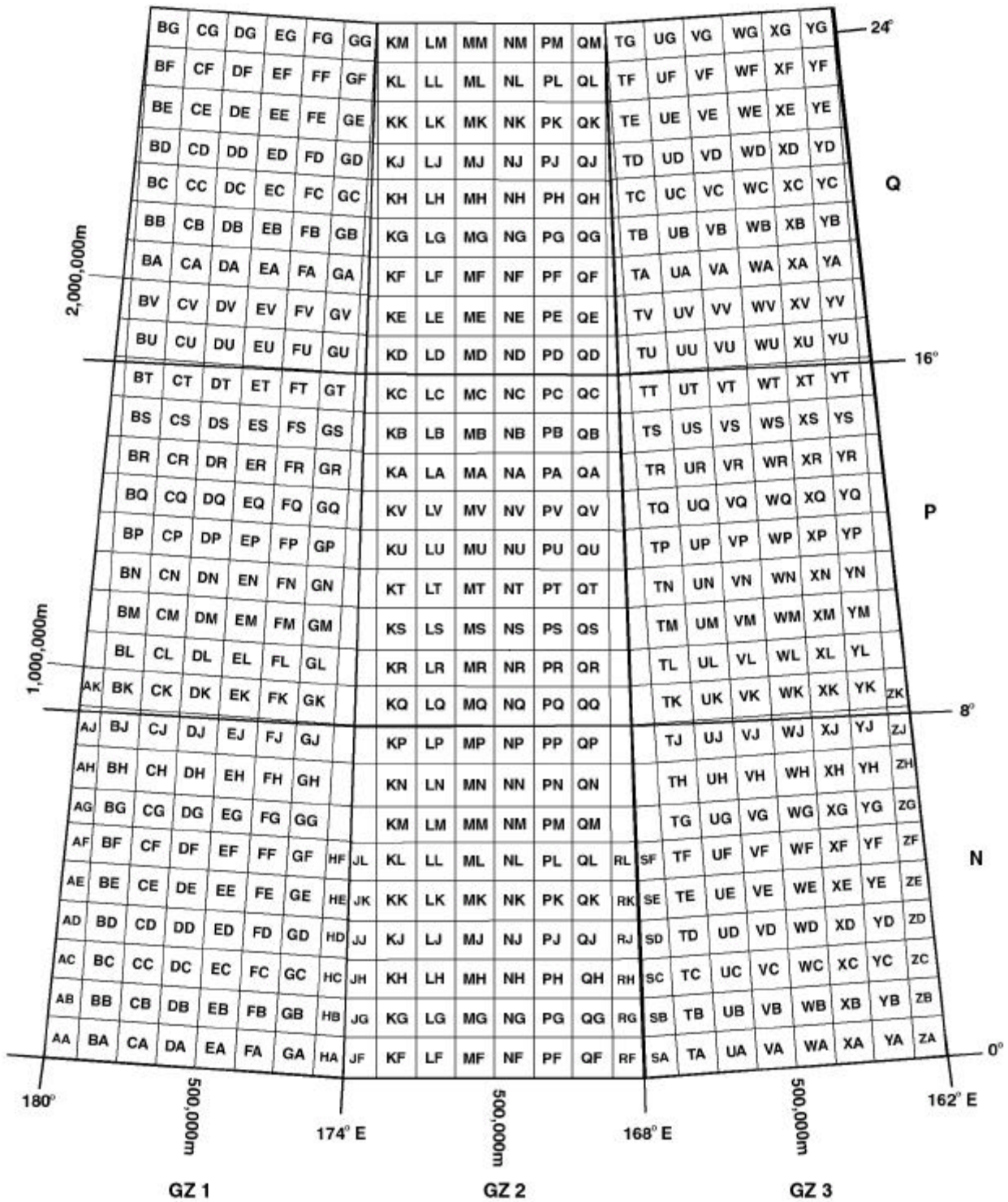

Figure 4-18. MGRS: 100,000-Meter Square Identification Lettering Convention for the UTM Grid, WGS 84/GRS 80 Ellipsoids.

100,000-Meter Square Identifier

Each UTM/UPS grid zone is divided into 100,000-meter squares. Squares are identified by two letters called a 100,000-meter square identifier. The first letter is columnar. It is the same for all squares in a north-south column. The second letter is linear. It is the same for all squares in an east-west row in a grid zone. This identifier is usually listed as part of the marginal information on a military map. The lettering convention used depends on the reference ellipsoid. This text discusses the UTM lettering convention used with the WGS 84 and GRS 80 ellipsoids and the UPS lettering convention used with the International ellipsoid. Other ellipsoid lettering conventions are detailed in DMA TM 8358.1, *Datums, Ellipsoids, Grids, and Grid Reference Systems*.

UTM

The first (columnar) letter of the 100,000 meter square identification originates at the 180° meridian with the letter A and increases alphabetically eastward along the Equator for three grid zones to cover an area of 18°. The 100,000-meter columns, including partial columns at grid zone junctions, are lettered from A to Z but omit I and O. This alphabet is repeated every 18° eastward around the Earth.

The second (linear) letter of the 100,000 meter square identification is lettered from A to V but omit I and O, from south to north covering an area of 2,000,000 meters and is then repeated northward. In odd-numbered grid zones, it originates at the Equator increasing alphabetically north. In even-numbered grid zones, the second letter originates 500,000 meters south of the Equator increasing alphabetically north. Therefore, in odd-numbered grid zones the second letter of the 100,000-meter square identification is A along the Equator. In even-numbered grid zones the second letter is F along the Equator.

Each 6° by 8° square is broken up into 100,000-meter squares that occur only once. For example, there is only one square identified by the letters WA inside of the 6° x 8° square of grid zone designation 3N. The only other square in this figure identified by the letters WA is in grid zone designation 3Q. It can be seen in figure 4-18 that unique coordinates can be established

for every position within the UTM grid using the MGRS.

UPS

The 100,000-meter square identifiers are the same for both UPS grid zones. The difference between two UPS grid MGRS coordinates with the same 100,000-meter square identifiers is the grid zone designator. A/B in the south, Y/Z in the north. Designators A and Y (Western Hemisphere) are lettered the same, as are designators B and Z (Eastern Hemisphere). The north zone only includes that portion of the lettering convention that falls inside of 84° latitude.

In the Western Hemisphere the first letter of the 100,000-meter square identifier originates at the intersection of the 80° latitude and 90° W longitude lines. It is lettered alphabetically along the east-west axis from J to Z. M, N, O, V, and W are omitted.

In the Eastern Hemisphere, the first letter of the 100,000 meter square identifier originates at the 0° and 180° meridians. It is lettered alphabetically along the east-west axis from A to R but D, E, I, M, N and O are omitted.

The second letter of the 100,000-meter square identifier originates at the intersection of the 80° latitude/180° longitude lines. It is lettered alphabetically from A to Z. I and O are omitted.

MGRS Grid Coordinates

Easting and northing coordinates used are the same as the grid coordinates used with UTM/UPS with the following modifications.

For UTM MGRS grid coordinates, delete the first digit (100,000 meters) from the easting and the first two digits (1,100,000 meters) from the northing of the UTM grid coordinates. Add the grid zone number, the zone designator, and the 100,000-meter square identifier at the front of the coordinates.

For UPS MGRS grid coordinates delete the first two digits (1,100,000 meters) from both the easting and northing UPS grid coordinates. Add the zone designator and the 100,000-meter square identifier at the front of the coordinates.

The entire MGRS grid coordinate is written as one entity without parentheses, dashes, or decimals. Examples:

3Q	location within a $6^{\circ} \times 8^{\circ}$ square
3QXV	location to within 100,000 meter
3QXV41	location to within 10,000 meters
3QXV4312	location to within 1,000 meters
3QXV432123	location to within 100 meters
3QXV43211234	location to within 10 meters
3QXY4321012345	location to within 1 meter

Nonstandard Grids

Many grid systems have been developed by individual nations that cover only that nation or a region surrounding that nation. Usually, no direct relationship exists between local grid systems (the same as no direct relationship exists between the state plane grid systems of the U.S.). Nonstandard grids are generally named for the nation or region they cover and contain the term grid, zone or belt; i.e., Ceylon Belt, MG, and India Zone I.

A grid covers a relatively small area. Its limits consist of combinations of meridians, parallels, rhumb lines, or grid lines. A zone is usually wide in longitude and narrow in latitude. Its limits consist of meridians and parallels. A belt is usually wide in latitude and narrow in longitude.

World Geodetic Reference System

The World Geodetic Reference System (GEOREF) is an alphanumeric system for reporting positions based on geodetic coordinates. It is a worldwide position

reference system that can be used with any map or chart graduated in latitude and longitude, regardless of the map projection. The primary use of the GEOREF is for inter-service and inter-allied positioning and reporting of aircraft and air targets.

User-Defined Grid Systems

When operating in an area that is mapped in a grid system other than UTM and UPS, it may be necessary to define the grid system. Defining the grid system is basically orienting a fire support system or survey system to measure or establish azimuths, distances, and elevations from a different origin than it is programmed for. Most current software versions do not allow this option. If the option is available, the following information is necessary:

- Operational ellipsoid.
- Ellipsoid parameters (a, b, 1/f).
- Scale factor (at the origin) for the projection.
- Latitude of the origin.
- Longitude of the origin.
- Unit (meters, feet, yards, chains or rods).
- False easting of the origin.
- False northing of the origin.

Figure 4-19 lists the needed information for several common nonstandard grids published in DMA TM 8358.1, table 6. See page 4-20.

Figure 4-20 lists the needed information for several common nonstandard grids not published in DMA TM 8358.1, table 6. See page 4-21.

NAME	PROJECTION	ELLIPSOID	ORIGIN			FALSE ORIGIN			SCALE FACTOR
			LATITUDE	LONGITUDE	EASTING	NORTHING	EASTING	NORTHING	
British West Indies	Transverse Mercator	Clarke 1880	00° 00' 00.000" N	62° 00' 00.000" W	400,000.000 m	0 m	0 m	0.9995	
Costa Rica									
Norte	Lambert	Clarke 1866	10° 28' 00.000" N	84° 20' 00.000" W	500,000.000 m	271,820.522 m	271,820.522 m	0.99995696	
Sud	Lambert	Clarke 1866	09° 00' 00.000" N	83° 40' 00.000" W	500,000.000 m	327,987.436 m	327,987.436 m	0.99995696	
Cuba									
Norte	Lambert	Clarke 1866	22° 21' 00.000" N	81° 00' 00.000" W	500,000.000 m	280,296.016 m	280,296.016 m	0.99993602	
Sud	Lambert	Clarke 1866	20° 43' 00.000" N	76° 50' 00.000" W	500,000.000 m	229,126.939 m	229,126.939 m	0.99994848	
Dominican Republic	Lambert	Clarke 1866	18° 49' 00.000" N	71° 30' 00.000" W	500,000.000 m	277,063.657 m	277,063.657 m	0.99991102	
Egypt	Transverse Mercator	International	00° 00' 00.000" N	25° 30' 00.000" E	300,000.000 m	0 m	0 m	0.99985	
				28° 30' 00.000" E					
				31° 30' 00.000" E					
				34° 30' 00.000" E					
				37° 30' 00.000" E					
El Salvador	Lambert	Clarke 1866	13° 47' 00.000" N	89° 00' 00.000" W	500,000.000 m	295,809.184 m	295,809.184 m	0.99996704	
Guatemala									
Norte	Lambert	Clarke 1866	16° 49' 00.000" N	90° 20' 00.000" W	500,000.000 m	292,209.579 m	292,209.579 m	0.99992226	
Sud	Lambert	Clarke 1866	14° 54' 00.000" N	90° 20' 00.000" W	500,000.000 m	325,992.681 m	325,992.681 m	0.99989906	
Haiti	Lambert	Clarke 1866	18° 49' 00.000" N	71° 30' 00.000" W	500,000.000 m	277,063.657 m	277,063.657 m	0.99991102	
Honduras									
Norte	Lambert	Clarke 1866	15° 30' 00.000" N	86° 10' 00.000" W	500,000.000 m	296,917.439 m	296,917.439 m	0.99993273	
Sud	Lambert	Clarke 1866	13° 47' 00.000" N	87° 10' 00.000" W	500,000.000 m	296,215.903 m	296,215.903 m	0.99995140	
Levant	Lambert	Clarke 1880	34° 39' 00.000" N	37° 21' 00.000" E	300,000.000 m	300,000.000 m	300,000.000 m	0.9996256	
Nicaragua									
Norte	Lambert	Clarke 1866	13° 52' 00.000" N	85° 30' 00.000" W	500,000.000 m	359,891.816 m	359,891.816 m	0.99990314	
Sud	Lambert	Clarke 1866	11° 44' 00.000" N	85° 30' 00.000" W	500,000.000 m	288,876.327 m	288,876.327 m	0.99992228	
Northwest Africa	Lambert	Clarke 1880	34° 00' 00.000" N	00° 00' 00.000" E	1,000,000.000 m	500,000.000 m	500,000.000 m	0.99908	
Palestine	Transverse Mercator	Clarke 1880 ¹	31° 44' 02.749" N	35° 12' 43.490" E	170,251.555 m ²	126,867.909 m	126,867.909 m	1.000	
Panama	Lambert	Clarke 1866	08° 25' 00.000" N	80° 00' 00.000" W	500,000.000 m	294,865.303 m	294,865.303 m	0.99989909	

¹ Clarke 1880 Ellipsoid for Palestine, a = 6,378,300.790 and 1/f = 293.466307656.

² Add 1,000,000.000 m to coordinate when coordinate becomes negative.

Figure 4-19. Specifications for Secondary Grids Listed in DMA TM 8358.1.

NAME	PROJECTION	ELLIPSOID	ORIGIN			FALSE ORIGIN			SCALE FACTOR
			LATITUDE	LONGITUDE		EASTING	NORTHING		
Camp Fuji, Japan (Shizuoka and Yamanashi Prefectures)	Transverse Mercator	Bessel	36° 00' 00.0000" N	138° 30' 00.0000" W		0 m	0 m	0.9999	
Marianas Islands									
Guam	Azimuthal Equidistant	Clarke 1866	13° 28' 20.879" N	144° 44' 55.503" E		50,000.000 m	50,000.000 m		
Rota	Azimuthal Equidistant	Clarke 1866	14° 07' 58.861" N	145° 08' 03.228" E		5,000.000 m	5,000.000 m		
Saipan	Azimuthal Equidistant	Clarke 1866	15° 11' 05.683" N	145° 44' 29.972" E		28,657.520 m	67,199.99 m		
Tinian	Azimuthal Equidistant	Clarke 1866	14° 56' 05.775" N	145° 38' 07.198" E		20,000.000 m	20,000.000 m		
MCAS Iwakuni, Japan	Transverse Mercator	Bessel	36° 00' 00.0000" N	132° 10' 00.0000" E		0 m	0 m	0.9999	
Okinawa, Japan	Transverse Mercator	Bessel	26° 00' 00.0000" N	127° 10' 00.0000" E		0 m	0 m	0.9999	
St. Barbara Area, Republic of Korea									
Central Zone	Transverse Mercator	Bessel	38° 00' 00.0000" N	127° 00' 10.405" E		0 m	0 m	1.0 (Unity)	
Subic Bay Area, Republic of the Philippines									
Zone III	Transverse Mercator	Clarke 1866	00° 00' 00.0000" N	121° 00' 00.0000" E		500,000.000 m	0 m	0.99995	
Tunisia									
Nord Tunisie Grid	Lambert	Clarke 1880 ¹	36° 00' 00.0000" N	09° 54' 00.0000" E		500,000.000 m	300,000.000 m	0.999625544	

¹ Clarke 1880 (French) Ellipsoid, a = 6,378,249.2 and 1/f = 293.4660208.

Figure 4-20. Specifications for Secondary Grids not Listed in DMA TM 8358.1.

CHAPTER 5. CONVENTIONAL EQUIPMENT

SECTION I. T-2E THEODOLITE

Components

The T2-E theodolite is a lightweight, compact, dust proof optical reading instrument equipped with a fixed reticle. This directional-type instrument measures horizontal angles and vertical readings.

Interior scales (circles) read by a built-in optical system are graduated in mils. Scales can be read directly to 0.001 mils. Circles are illuminated by sunlight or a built-in wiring system that produces artificial light.

All parts of the instrument that can be damaged by dust or moisture are enclosed.

The T-2E is divided into the tribrach, the lower part, and the alidade. See figures 5-1 and 5-2.

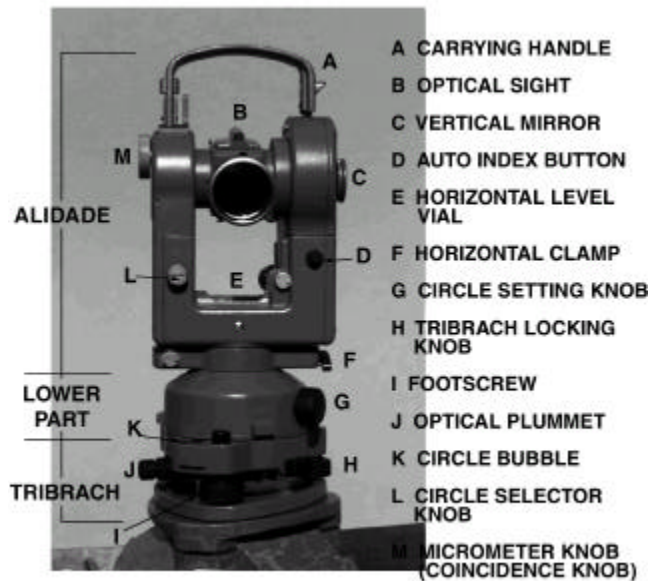

Figure 5-1. T-2E Components.

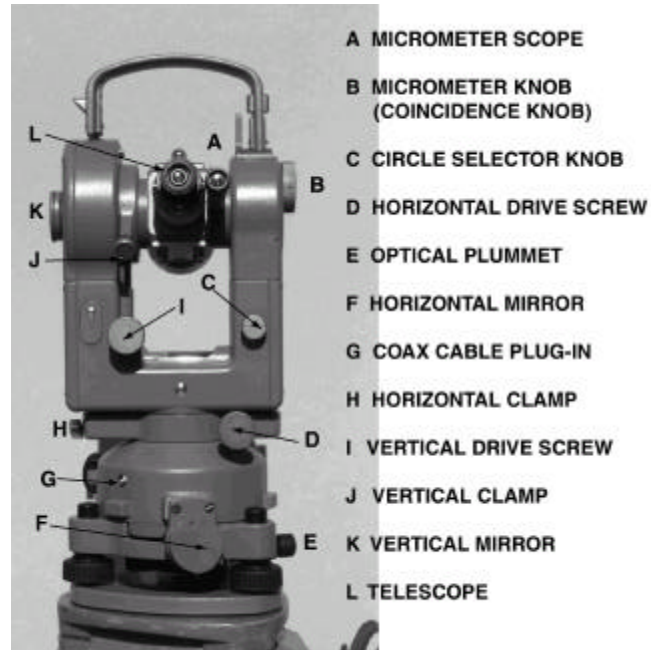

Figure 5-2. T-2E Components (Continued).

The most commonly used tribrach for the T-2E is the GDF22. See figure 5-3. It is also used with the target set. The GDF22 mounts on all tripods with a standard 5/8-inch fixing screw. It has three leveling knobs, a fish eye level, an optical plummet, and a swivel-locking knob that attaches to the lower part to the theodolite.



Figure 5-3. GDF22 Tribrach.

The lower part contains the centering flange that attaches to the tribrach. It also contains the standing axis system, the horizontal circle, the circle setting knob, the horizontal mirror, and the cable plug-in for use with artificial light.

The lower part provides a fixed rotational axis around the standing axis system for the alidade. The standing axis system consists of the axis sleeve that is rigidly connected to the centering flange and the axis stem that is screwed fast to the alidade.

The alidade contains the telescope, reading microscope, and most of the T-2E operator controls.

The horizontal locking clamp fixes the alidade to the lower part so that the alidade cannot be rotated except by the horizontal drive screw. The horizontal drive screw rotates the alidade for fine adjustments in pointing.

The vertical locking clamp fixes the tilting axis of the telescope so that it cannot be rotated except by the vertical drive screw. The vertical drive screw rotates the tilting axis of the telescope for fine adjustments in pointing.

The circle selector knob allows the operator to change his view from the horizontal circle to the vertical circle.

The micrometer knob brings the horizontal and vertical scales into coincidence.

The automatic index button checks the functioning of the automatic index. This ensures that any residual error in leveling is eliminated.

Telescope

The telescope provides an erect (upright) view of the target. The reticle pattern is focused by rotating the eyepiece. The target is focused by rotating the silver-focusing sleeve. The reticle pattern is a 1 to 100 scale stadia pattern for optical distance measurements. See figures 5-4 and 5-5.

To remove the eyepiece, rotate the bayonet ring counterclockwise so that another eyepiece can be installed. The standard eyepiece has a 30X lens. Optional eyepieces include the 40X FOK53 and the 18X FOK 117.

When using artificial illumination, the lever under the optical sight can be pushed toward the objective lens (front) to illuminate the reticle.

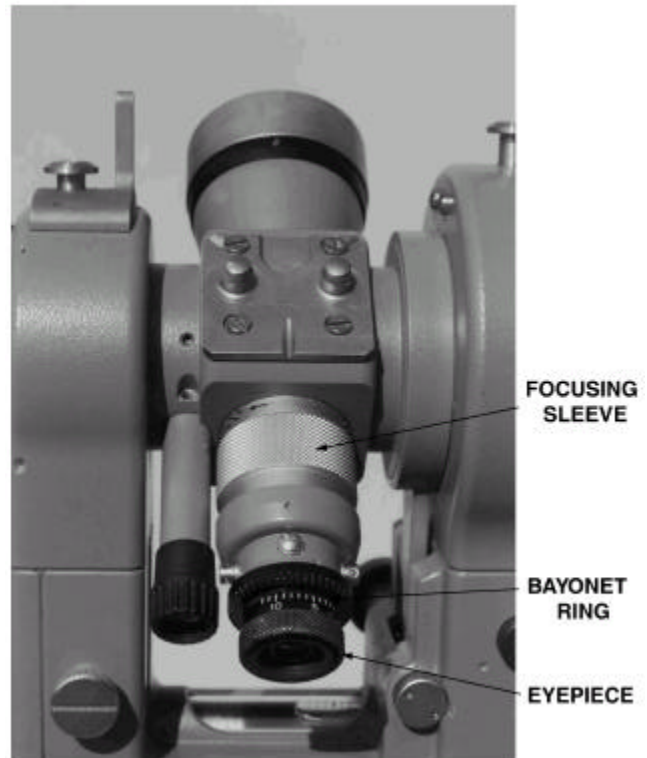

Figure 5-4. T-2E Focusing Sleeve and Eyepiece.

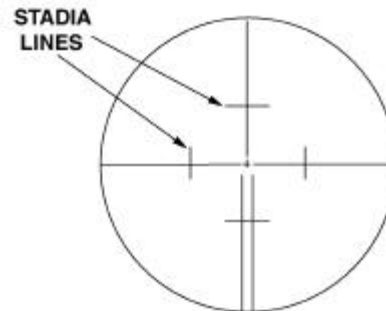

Figure 5-5. T-2E Reticle Pattern.

Accessories

Accessories (one each) are carried and stored in the plastic transportation case. Accessories are—

- Users manual.
- Eyepiece assembly with carrying case.
- MZ2 elbow microscope and a GFZ1 elbow telescope.
- GOF4 black sun filter.
- Jewelers screwdriver with two adjusting pins and two standard screwdriver blades.
- Plastic wet weather instrument cover.
- GSP-1 Roelofs Prism with case.
- Illumination Kit (two GEB-58 plug-in lamps, one GEV-34 cable, and one GEB-63 battery box).

Setting Up the Tripod GST-20

The GST-20 tripod is the primary tripod used with conventional survey equipment in the Marine Corps.

Upend the tripod, place the tripod head on the toe of your boot, and unbuckle the restraining strap. Loosen the leg clamp thumbscrews and extend the tripod legs to the desired length. Tighten the leg clamp thumbscrews sufficiently to maintain the weight of a T-2E and DI 3000. Do not force the thumbscrews.

Spread the legs and place the tripod over the occupied station with one leg bisecting the angle to be measured. Set up the tripod head so that the telescope will be at a convenient height for the operator. Rough level the tripod.

Insert the bayonet of the plumb bob into the instrument fixing screw. The plumb bob should hang about 1 inch above the station. Center the tripod over the station to within approximately 1 inch of plumb.

Firmly embed the tripod legs in the ground. The plumb bob should now be within 0.5 inches laterally of center of the station. The tripod head must approximate level once the legs are embedded in the ground.

Remove the tripod head cover. Fix the cover to the side of the tripod and lightly wipe your hand over the tripod head to remove any sand or dirt.

Mounting the T-2E on the Tripod

Open the theodolite's transportation case. Grasp the theodolite by the right standard (this faces up in the transportation case) and remove the theodolite. Place the free hand underneath the tribrach. Maintain a hold on the instrument with at least one hand until the T-2E is securely tightened to the tripod.

Carefully place the theodolite on top of the tripod. Keeping one hand on the instrument, attach the T-2E to the tripod head by screwing the fixing screw snugly into the base of the tribrach.

Replace the cover on the transportation case to protect from dust and moisture. Move the case away from the tripod to provide a working area for the instrument operator.

Plumb and Level the T-2E

Step 1. Loosen the fixing screw slightly. Carefully slide the instrument on the tripod head to center the point of the plumb bob exactly over the station.

Step 2. With one hand on the theodolite, tighten the fixing screw. Excessive tightening of the fixing screw will bend the tripod's slotted arm and damage the tripod head. Be sure the point of the plumb bob remains centered over the station. Remove the plumb bob and return it to its case.

Step 3. Loosen the horizontal clamping screw. Rotate the alidade until the axis of the plate level is parallel to any two of the three leveling screw knobs. Grasp the leveling screw knobs between the thumb and forefinger of each hand. Turn the knobs at the same time so the thumbs of both hands move either toward each other or away from each other. This movement tightens one screw as it loosens the other. The bubble always moves in the same direction as the left thumb. Center the bubble by using these two leveling screw knobs. This is the first position. See figure 5-6 on page 5-4.

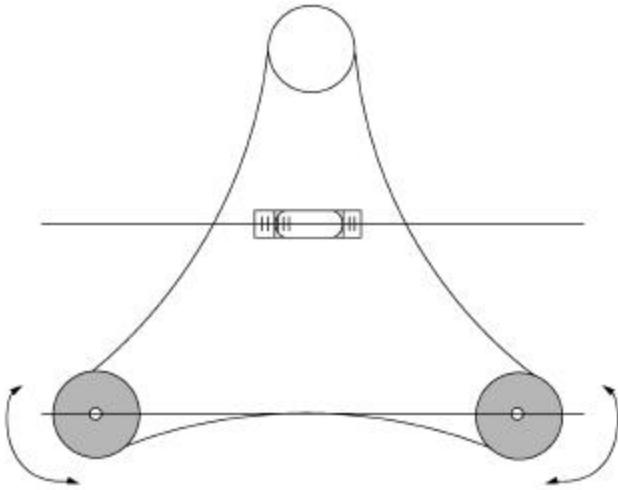

Figure 5-6. First and Third Leveling Position.

Step 4. Rotate the alidade clockwise 1600 mils. This second position places the axis of the tubular level at a right angle to the first position. Using the third leveling screw knob only, center the bubble. See figure 5-7.

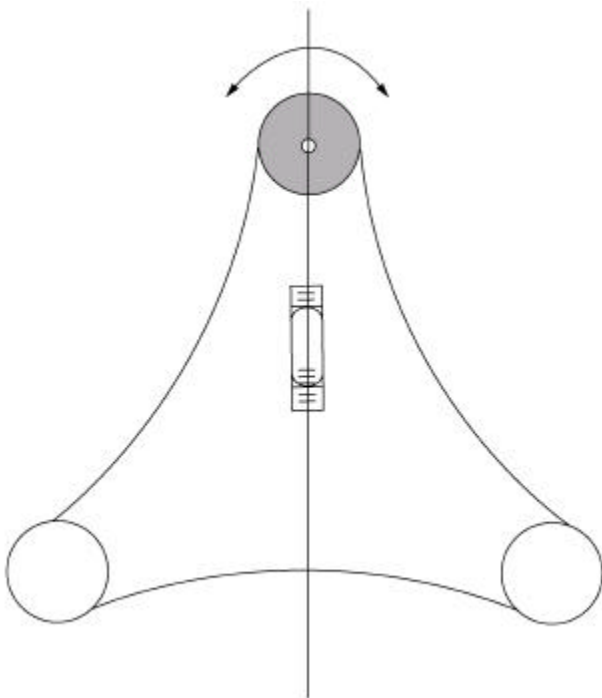

Figure 5-7. Second and Fourth Leveling Position.

Step 5. Rotate the alidade clockwise 1600 mils so that it is 3200 mils from the first position. Level the instrument using the same two leveling screws used in the first position. This is the third position.

Step 6. Rotate the alidade clockwise 1600 mils so that it is 3200 mils from the second position. Level the instrument using the same single leveling screw used in the second position. This is the fourth position.

Step 7. Repeat Steps 5 and 6 above until the bubble remains centered in both positions.

Step 8. Rotate the alidade to the first position. If the bubble remains centered in this position, rotate the alidade to the second position. If the bubble remains centered in this position, rotate the alidade throughout 6400 mils. If the bubble remains centered the instrument is level.

Step 9. If the bubble does not remain centered during the procedures in Step 8 but does remain within one graduation, level the instrument by bringing the bubble halfway back towards the centered position. If the bubble continues to move more than one graduation, the plate level adjustment should be performed.

Step 10. After the instrument is level, check the optical plumb to ensure that the instrument is centered exactly over the station. If it is not, center the instrument over the station by loosening the fixing screw on the tripod and shifting the instrument on the tripod head. Check the level of the instrument. Repeat the leveling process if needed. Check the optical plumb again. Repeat this process until the instrument is level and centered over the station. The optical plumb must be in proper adjustment. If not, the plumb bob may be a more accurate method of plumbing the instrument.

Eliminating Parallax and Adjusting Focus

Before using the theodolite to measure angles, the reticle parallax must be eliminated and the telescope brought into focus. Parallax is eliminated by bringing the focus of the eyepiece and the focus of the objective lens to the plane of the reticle (crosslines). Point the telescope toward the sky or a uniformly light surface. Rotate the knurled ring of the eyepiece until the reticle pattern is sharp, distinct lines. Focus your eyes on the cross hairs and not on the sky. Point the telescope

toward a well-defined distant point. While focusing on the cross hairs, bring the distant point into a clear, sharp image by rotating the focusing sleeve on the telescope.

To check for parallax, use the horizontal drive screw to center the vertical cross hair on the point. Move your eye horizontally back and forth across the eyepiece. If parallax is eliminated, the cross hair will remain fixed on the object as you move your eye. If parallax is not eliminated, the cross hair will move back and forth across the object. To eliminate any remaining parallax, change the focus of the eyepiece slightly to bring the crosslines into sharper focus and refocus the telescope accordingly until there is no apparent motion.

Pointings

Once the parallax has been eliminated and the instrument is in focus, the instrument operator is ready to make pointings on targets. These procedures are the same for all pointings. However, placement of the cross hairs depends on the type of target.

For pointings on a range pole, the standard rule is to make the pointing centered on the lowest visible point. When the range pole is too close to the theodolite to judge the center, the operator can point to the left side of the range pole with the telescope in the direct mode and the right side in the reverse mode. The mean between the direct and reverse will produce an angle measured from the center of the range pole but will usually not meet the 0.150 mil specification between direct and reverse readings. See figure 5-8.

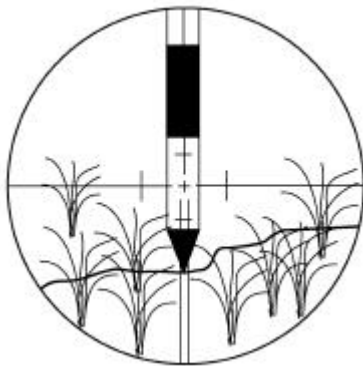

Figure 5-8. Pointings on a Range Pole.

When making pointings on the target plate (GZT1) of a target set, the instrument operator should center the cross hairs so that the vertical line is centered up and down in the thin white extension of the small triangles. The horizontal line should center left and right in the thin extension of the large white triangle. See figure 5-9.

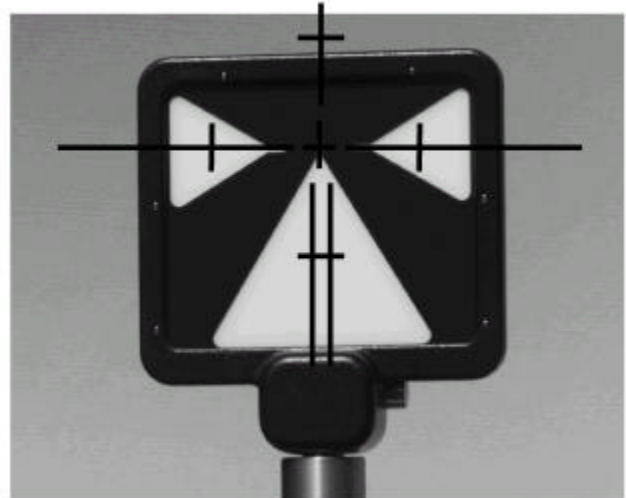

Figure 5-9. Pointings on a Target Plate (GZT1).

For pointings to a target reflector (GRZ3) with a single or triple prism holder (GPH1Z or GPH3Z), the instrument operator should center the cross hair below the optical sight of the target reflector at the intersection of the three yellow triangles. The target reflector must be correctly oriented towards the theodolite for an accurate sighting. See figure 5-10.

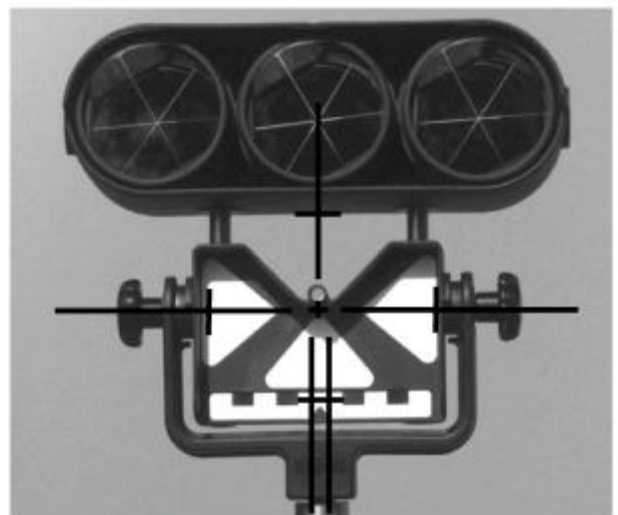

Figure 5-10. Pointings on a Target Reflector (GRZ3).

When making pointings to an eleven-prism holder, the instrument operator should center the cross hairs on the center prism. Since this prism configuration is not to be used for distances under 500 meters, parallelism with the DI 3000 is not affected. If using the target lamp (GEB72), place it in the center portal and use to make pointings. See figure 5-11.

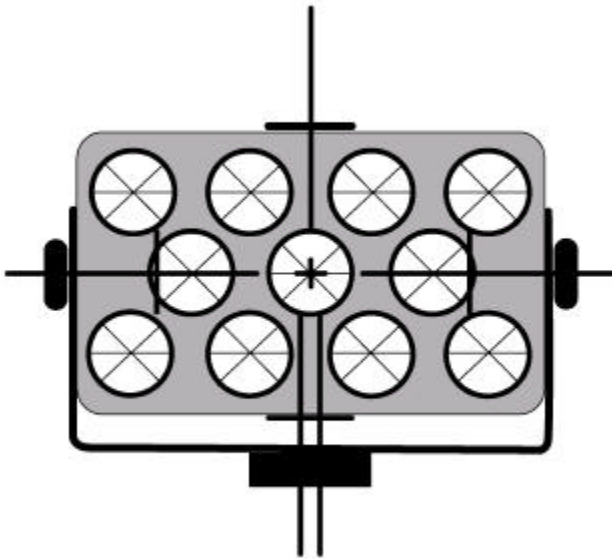

Figure 5-11. Pointings on an Eleven-Prism Holder (GPH11).

To make a pointing on a target, unlock the horizontal and vertical clamp and point the telescope towards the target. Roughly align the telescope on the target with the optical sight. Lock the horizontal and vertical clamps. Use the horizontal and vertical drive screws to center the crosslines on the target as described above. The last turn of the horizontal and vertical drive screws should always be clockwise against the spring.

Reading The Scales

A system of lenses and prisms permits the instrument operator to see small sections of either the horizontal or vertical circles. The circles are viewed through the circle-reading microscope eyepiece located beside the telescope. The observer selects the circle to be viewed by turning the circle-selector knob located on the right

standard. The field of view of the circle-reading microscope contains three small windows. When the red line on the circle-selector knob is horizontal, the three windows will be yellow and horizontal readings are taken. When the red line on the circle selector knob is vertical, the three windows will be white and vertical readings are taken. See figure 5-12.

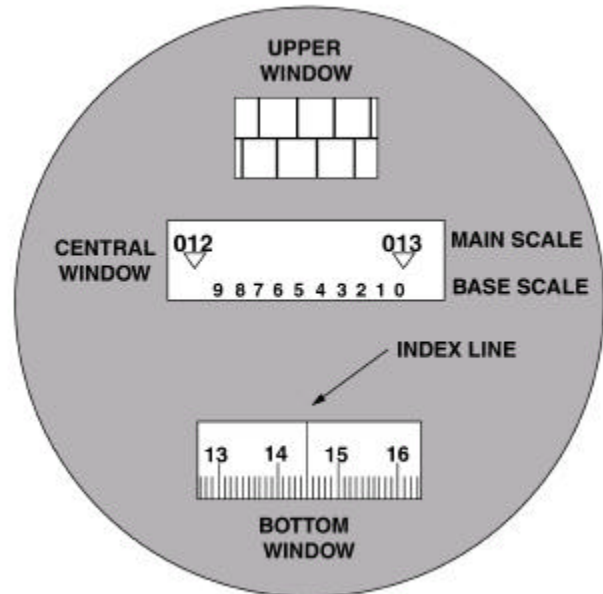

Figure 5-12. View of the T-2E Scales.

Upper Window

This window is sometimes referred to as the coincidence scale. When viewing this window, two images of graduation lines of diametrically opposite parts of the circle are seen. Both images move in opposite directions and appear to be separated by a fine line. The interval between gradations on each circle is 2 mils but coincidence between the circles occurs every 1 mil.

Central Window

The central window has the main scale and the base scale. The main scale in the upper portion of the central window. It is made up of sets of three-digit numbers representing tens of mils. In other words, 0 mils appears as 000; 10 mils as 001; 450 mils as 045;

and 6390 mils as 639. Each three-digit number is centered above a triangular index that reads the base scale. The base scale is in the bottom portion of the central window. It consists of a stationary scale numbered 9 through 0, from left to right. Each number represents its value in mils; e.g., 9 equals 9 mils and 1 equals 1 mil.

Bottom Window

This window is called the micrometer scale. It is graduated clockwise from -0.006 mils to 1.006 mils in 0.001 mil increments. The scale is numbered every 0.010 mils. A stationary index line is set vertically across the center of the window.

Coincidence

Optical coincidence is obtained by aligning diametrically opposite graduations of a circle by turning the micrometer knob. Graduations of the circle (upper window) are brought into coincidence by making the graduations appear to form continuous lines across the dividing line. See figure 5-13.

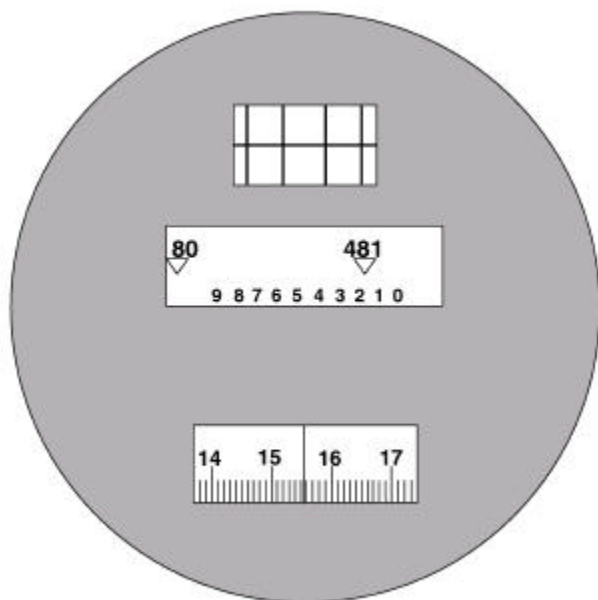

Figure 5-13. Sample Circle Reading.

To bring the scales into coincidence, rotate the micrometer knob forward and then back through its complete range of motion. Looking into the microscope, view only the upper window.

Rotate the micrometer knob until the graduations in the top and bottom circles form single continuous vertical lines across the thin horizontal line of the upper window.

Circle Readings

Once the operator has sighted on the target and brought the scales into coincidence, he is ready to announce circle readings. This is done by reading the central and lower windows from top to bottom. Procedures for reading the scales are the same for horizontal and vertical readings.

Viewing the central window, only one triangular index in the main scale will be over the base scale. Announce the three digits above that index, and then announce the digit in the base scale directly under the index. Figure 5-13 shows 481 from the main scale and 2 from the base scale.

Viewing the bottom window, read the two digits directly to the left of the index line. Determine the value of the graduation closest to the index line. Announce the three digits together preceded by the word "point" to designate the position of the decimal. Figure 5-13 shows 156 in the bottom window. When the index line appears to be centered between two graduations, the instrument operator should read the even number.

The circle reading should be announced in individual digits for proper recording. Numbers are said as "four, eight, one, two, point, one, five, six."

Setting the Horizontal Circle

The horizontal circle of the T-2E cannot be fixed. Before setting the circle, a pointing at a target must be made and the horizontal clamp locked. Generally, there are two situations that require the instrument operator to set the horizontal circle: establishing an initial circle setting and orienting the telescope along a line of known azimuth.

Initial Circle Setting

An initial circle setting is used during the process of measuring a horizontal angle. It provides a buffer for both operator pointing errors and horizontal collimation error.

Make a pointing on the rear station. Ensure the circle-selector knob is set for the horizontal circle.

Use the micrometer knob to set 0.150 mils on the micrometer scale (bottom window).

Rotate the circle setting knob so that the triangular index located under the 000 number of the main scale is directly over the 0 on the base scale.

Use the circle setting knob to bring the upper window into coincidence. Make sure the reading in the central window is still 0 mils. Close the cap over the circle setting knob.

Rotate the micrometer knob forward then back through its complete range of motion. Looking into the microscope, view only the upper window.

Use the micrometer knob to bring the upper window into coincidence.

Read the horizontal circle. The reading should be within ± 0.100 mils of 0.150.

Orienting the Scale

The horizontal circle of the T-2E can be set so that the circle reading will correspond to a known azimuth to a target or station. The azimuth to any point on which the telescope is oriented can be read directly from the horizontal circle.

To orient the horizontal circle, make a pointing on the station that lies along the known azimuth. Ensure the circle-selector knob is set for the horizontal circle.

Use the micrometer knob to set the decimal mils value of the known azimuth on the micrometer scale (bottom window). For example, if the known azimuth is 2176.987 mils, the operator will set 0.987 on the micrometer scale.

Rotate the circle-setting knob so that the triangular index located under the tens of mils value of the known azimuth in the main scale is directly over the 1's value on the base scale. Again, if the known azimuth is 2176.987 mils, the operator places the triangular index under 217 in the main scale over the 6 in the base scale.

Use the circle setting knob to bring the upper window into coincidence. Make sure the reading in the central and bottom windows still equals the known azimuth. Close the cap over the circle setting knob.

Horizontal Angles

Position Angle

The horizontal circle of the T-2E is a clockwise scale. All horizontal readings from this instrument are said to be clockwise horizontal angles. This should not be confused with the rotational direction of the alidade. The alidade is rotated clockwise in the direct mode and counterclockwise in the reverse mode. Procedures for measuring a horizontal angle follow.

Step 1. With the telescope in the direct mode, point to the rear station. Set the circle selector knob for the horizontal circle. Set the initial circle setting and announce it to the recorder. Each time the recorder reads back a set or measured angle the operator must be looking into the micrometer scope to verify the reading.

Step 2. Rotate the alidade clockwise to the forward station. Make a pointing at the forward station and announce the circle reading to the recorder.

Step 3. Plunge the telescope to the reverse mode and make a pointing at the forward station. Announce the circle reading to the recorder.

Step 4. With the telescope in the reverse mode, rotate the alidade counterclockwise to the rear station. Make a pointing at the rear station and announce the reading to the recorder.

Steps 1 through 4 above constitute one direct and one reverse pointing on each station. This is called a one-position angle.

Multiple Angles

When it is necessary to measure the angle to more than one station, make a pointing on the rear station with the telescope in the direct mode and then on each station around the horizon in a clockwise direction.

After obtaining a circle reading on the last station, plunge the telescope and make a pointing at each station in a counterclockwise direction. Start with the last forward station and end with the rear station. One set of direct and reverse pointings on all of the observed stations constitutes one position. This is called measuring a multiple angle.

Circle Closure

The direct and reverse circle readings at each station should differ by 3200 mils, ± 0.150 mils.

If the difference between direct and reverse readings is constant over several pointings, it can be assumed that the error is in the horizontal collimation of the instrument. This error can be corrected through horizontal collimation adjustment.

If the difference is not relatively constant, the error is a mixture of collimation error and operator error. In this case, the instrument should not be adjusted until constant errors are measured.

Two-Position Angle

In artillery survey, one-position angles are normally measured. However, it may be necessary to measure a two-position angle. This method measures the same angle twice and uses the mean of the two measurements. The first position angle is measured as described previously. The second position angle is measured the same way except that the initial pointing at the rear station is performed in the reverse mode. The horizontal circle is set to 4800.150 mils (± 0.100) for an initial circle setting.

When two-position angles are observed, the two measured angles cannot differ by more than 0.050 mils. If they do, the angles must be rejected and remeasured.

Vertical Angles

The T-2E does not measure vertical angles directly. The vertical circle places 0 mils at the zenith. So vertical circle readings are zenith angles, or in artillery, vertical readings. See figure 5-14.

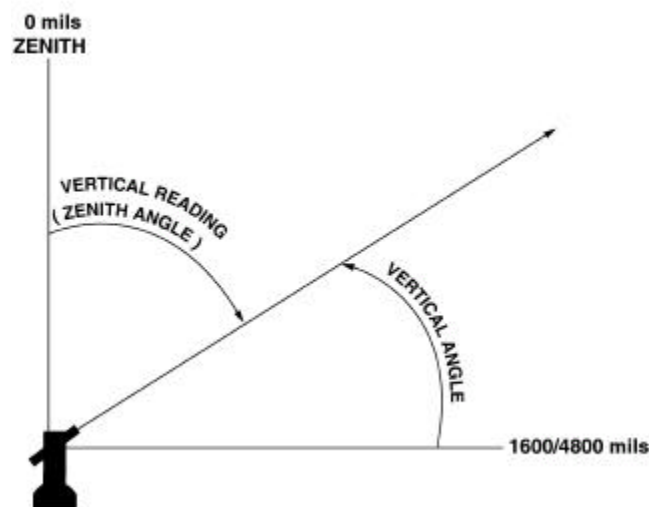

Figure 5-14. Vertical Readings/Angles.

To convert a vertical reading to a vertical angle, the recorder determines the angular difference between the horizon and the line of sight. The horizon is 1600 mils in the direct mode and 4800 mils in the reverse mode; the line of sight is the vertical reading (zenith angle).

The vertical angle is positive if the line of sight is above the horizon (vertical readings less than 1600 mils and greater than 4800 mils). It is negative when the line of sight is below the horizon (vertical readings greater than 1600 mils and less than 4800 mils).

Vertical Index

The T-2E has an automatic vertical index. Its functioning is checked as part of each vertical reading. To check, the operator presses and releases the black index button located on the left standard. Holding it in will eventually compress the spring and cause the automatic index to malfunction. While pressing the button, he must view the upper window in the

microscope. If the instrument is properly leveled, the graduation lines on the vertical circle will swing away from each other and then settle back smoothly to their original position. This verifies that the index is functioning properly. If the graduation lines do not settle back smoothly to their original position but jerk to a stop, the instrument must be leveled again or turned in for maintenance.

Determining Vertical Readings

Make a pointing on the target in the direct mode. Set the circle selector knob for the vertical circle. While viewing the upper window in the microscope, press the index button to check the automatic index. Viewing only the upper window, bring the scale into coincidence using the micrometer knob.

Announce the circle reading to the recorder. When the recorder reads this back the operator must be looking into the microscope to verify the reading.

Plunge the telescope to the reverse mode and make a pointing at the target. While viewing the upper window in the microscope, press the index button to check the automatic index. Viewing only the upper window, bring the scale into coincidence using the micrometer knob.

Announce the circle reading to the recorder. When the recorder reads this back the operator must be looking into the microscope to verify the reading.

The procedures described above are the same whether the pointings are made to a forward station or to a rear station.

Once the recorder has determined the vertical angles from the vertical readings, the direct and reverse vertical angles at each station should be the same (± 0.150 mils).

If the difference between direct and reverse readings is constant over several pointings, assume that the error is in the vertical collimation of the instrument. If the difference is not relatively constant, the error is a mixture of collimation error and operator error. In this case, the instrument should not be adjusted until constant errors are measured.

Reciprocal Vertical Angles

A reciprocal vertical angle is the mean of two vertical angles measured in opposite directions along the same leg. The sign of the reciprocal vertical angle is the same as the sign of the vertical angle measured from the occupied station to the forward station.

Measuring a reciprocal vertical angle diminishes the effects of refraction and Earth curvature. Refraction is the bending and slowing of light as it passes through the Earth's atmosphere. The angle of refraction is affected by temperature and pressure. Reciprocal vertical angles should be measured through similar atmospheric conditions. The time span between measuring reciprocal vertical angles should be as short as possible.

The effects of curvature of the Earth are minimal at distances under 1,000 meters. Corrections are not used in manual computations. Reciprocal vertical angles completely negate the effects of Earth curvature. This is why reciprocal vertical angles for all legs of a survey longer than 1,000 meters in both fourth and fifth order surveys must be measured.

Most computers and software for computing surveys will prompt reciprocal vertical angles. If you tell the computer that reciprocal vertical angles were not measured, the computer will apply an Earth curvature correction to the distance. If reciprocal vertical angles were measured, the computer will not apply those corrections.

March Ordering

Open the transportation case and place it near the tripod. Place the black cap over the objective lens of the telescope. Place the telescope in a vertical position with the objective lens down. Lock the vertical clamp. Replace any parts of the T-2E that were taken off during operation. Close the mirrors and circle-setting knob cover. Center the leveling screws on the tribrach.

Rotate the alidade so that the red line on the right standard is aligned with the red line on the lower part.

Lock the horizontal clamp. Hold the theodolite by its right standard and unscrew the tribrach from the fixing screw. Lift the theodolite from the tripod and secure it in the transportation case. Replace the tripod head cover, collapse the tripod legs, and strap the legs together. Make sure the legs are securely tightened.

Tests and Adjustments

Keep the theodolite in correct adjustment for accurate results. There are five operator tests and adjustments of the T-2E theodolite. When a test indicates that an adjustment is needed, the operator adjusts and retests for accuracy before making the next test in sequence. Tests and adjustments are made with the instrument mounted on its tripod. Setup the instrument in the shade, on firm ground, with the head of the tripod as level as possible. Protect it from the wind. Tests and adjustments must be made in the following sequence:

- Plate level.
- Circular bubble.
- Optical plumb.
- Horizontal collimation.
- Vertical collimation (index error).

Plate Level

The plate level adjustment aligns the vertical axis of the theodolite to a line that is perpendicular to the geoid when the bubble of the plate level is centered in its vial.

Unlock the horizontal clamp and rotate the alidade until the axis of the plate level is parallel with any two leveling screws. Center the bubble using those two screws. Rotate the alidade clockwise through 1600 mils and center the bubble with the third leveling screw.

Rotate the alidade through 3200 mils. Noting the position of the bubble, use the third leveling screw to bring the bubble halfway back to its centered position. Use an adjusting pin from the jewelers screwdriver to carefully turn the adjustment screw until the bubble centers. The adjustment screw is located inside a small aperture at the bottom of the left standard.

Repeat these steps until the bubble remains centered within one graduation for all positions of the alidade.

Circular Bubble

This adjustment makes sure the vertical axis of the tribrach aligns with the vertical axis of the theodolite. This is very important when taking the T-2E off the tribrach and replacing it with a target carrier.

This test ensures that when the plate level is level to within one graduation of center, the circular bubble must be centered or adjusted.

On the GDF22 tribrach, two capstan screws are accessible via the side slits under the circular bubble. As either screw is loosened, the bubble runs towards it; as it is tightened the bubble runs away.

Use an adjusting pin in the jeweler's screwdriver to turn one of the two capstan screws until the bubble is located on a line between the center of the circle and the other screw.

Turn the other screw until the bubble is centered in the circle. Repeat if necessary. Do not turn the screws anymore than is necessary.

Optical Plumb

This adjustment makes the vertical axis of the GDF22 tribrach pass through the station mark when the theodolite (or target carrier) is properly leveled and plumbed. This test requires that a theodolite or a target carrier be mounted in the tribrach. Leveling must be precise to test the optical plummet. The plate level of the theodolite or target carrier must have been already adjusted to perform this test.

Set up and fine level the theodolite on a level tripod. Attach a plumb bob to the fixing screw.

Place a piece of paper or tape on the ground under the plumb bob. Use a fine tip pen to mark the plumb point on the paper. Rotate the plumb bob's bayonet plug and mark several positions through 6400 mils. Determine the center position of all the marks.

Remove the plumb bob. The tribrach should be optically plumb over the center of the plumb bob marks. If not, adjust the optical plumb.

The optical plumb has two adjusting screws located on the optical plumb arm under the tribrach. To adjust the optical plumb, look through the optical plumb. Use two jewelers screwdrivers to turn the adjustment screws in small increments in the direction shown in figure 5-15 at the same time until the optical plumb is centered over the mark.

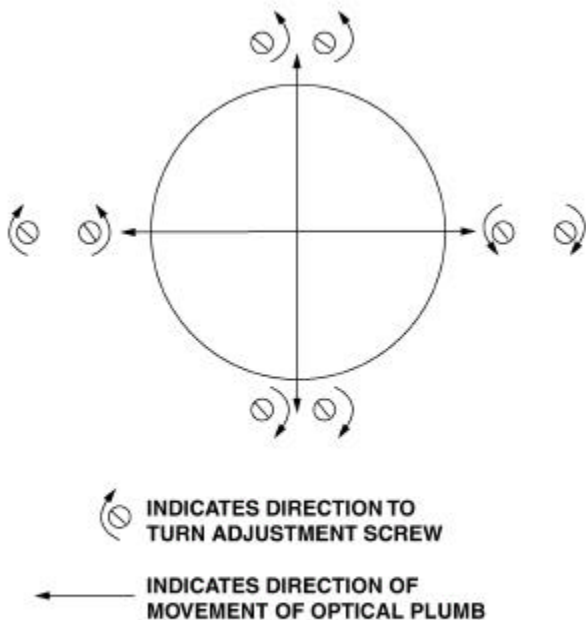

Figure 5-15. Optical Plumb Adjustment Screws.

Horizontal Collimation

This adjustment makes the line of sight perpendicular to the tilting axis of the telescope.

To test, select a well-defined point at least 100 meters from and at about the same elevation as the instrument. With the telescope in the direct position, center the vertical cross hair on the target and read the horizontal circle reading to the recorder. Plunge the telescope to the reverse position and take a reverse reading to the same point.

The difference between the direct and reverse readings should be exactly 3200 mils. Assuming no operator error is present, the discrepancy between the actual difference in the two readings and 3200 mils is the apparent horizontal collimation error or twice the actual horizontal collimation error. If the apparent

horizontal collimation error exceeds the specified standard (0000.150 mils for the T-2E), the operator should perform the horizontal collimation adjustment.

The horizontal collimation is adjusted as small as possible at the factory but cannot be completely eliminated by adjustment. For this reason, adjustments of the horizontal collimation should only be made when absolutely necessary. Another reason is that if the adjustment screws are not set correctly (too loose or tight), the instrument will not maintain the adjustment.

To adjust the horizontal collimation error, with the telescope on the point in the reverse position, set the mean value of the direct and reverse pointings on the micrometer scale by using the coincidence knob. Bring the main scale into coincidence by using the horizontal tangent screw. This moves the vertical crossline of the telescope off the point by the amount of the actual horizontal collimation error.

Use the adjusting pins in the jewelers screwdriver to align the vertical crossline back on the point by lateral movement of the reticle within the telescope. The T-2E has two pull-action capstan adjusting screws arranged horizontally and on opposite sides of the telescope. To align the vertical cross hair, loosen one screw and tighten the opposite one an equal amount. The cross hair will move laterally toward the screw that you tighten. Do not try to make the entire adjustment in one step. Loosen and tighten the opposite screws in small amounts. Proceed in this manner until the cross hair is aligned on the station. Make sure the capstan screws are rotated equally; otherwise the reticle will be too loose or too tight and will not remain in adjustment.

Perform the horizontal collimation test again. Make additional adjustments as needed until the difference between the direct and reverse pointings is less than 0.150 mils.

Vertical Collimation (Index Error)

This adjustment makes the line of sight perpendicular to the zenith when the vertical circle reads 1600 mils with the telescope in the direct position or 4800 mils with the telescope in the reverse position. The sum of the direct and reverse readings should equal 6400 mils. Any difference between the sum of the two readings and 6400 mils is the apparent vertical collimation error

(or twice the actual error). If the difference exceeds 0.150 mils, adjust the vertical index.

The index error is adjusted as small as possible at the factory but cannot be eliminated by adjustment. For this reason, adjustments of the vertical collimation should only be made when absolutely necessary.

To adjust, with the telescope in the reverse position and accurately sighted on the selected point, use the micrometer knob to set the fractional part of the corrected reading on the micrometer scale. This will bring the scale out of coincidence. See figure 5-16 to compute the corrected reading.

Direct Reading:	1609.812	1598.216
Reverse Reading:	4790.715	4801.208
SUM=	6400.527	5399.424
Apparent Error:	+0.527	-0.576
Actual Error:	+0.264	-0.288
Correction:	-0.264	+0.288
Corrected Reading:	4790.451	4801.496

Figure 5-16. Computing the Corrected Reading.

Use the wide tip in the jewelers screwdriver to open the index cover located beside the vertical drive screw to show the index adjustment screw. Turn the index adjustment screw until coincidence is obtained in the upper window of the scales. Close the index cover.

Repeat the test and adjust as needed until the sum of the direct and reverse pointings is within 0.150 mils of 6400.

Artificial Illumination

The T-2E theodolite is equipped for artificial illumination by way of a coaxial socket located on the lower part of the theodolite and an illumination kit. The horizontal and vertical circle can be illuminated as well as the reticle.

All components of the illumination kit are stored in the GEB-63 battery box. The battery box has three socket

holes along its bottom edge. The largest of these socket holes is for a cable connected to an external power source; i.e., GEB-70 battery. The other two holes are for instrument illumination. The battery box also has an ON/OFF switch located on its side. See figure 5-17.

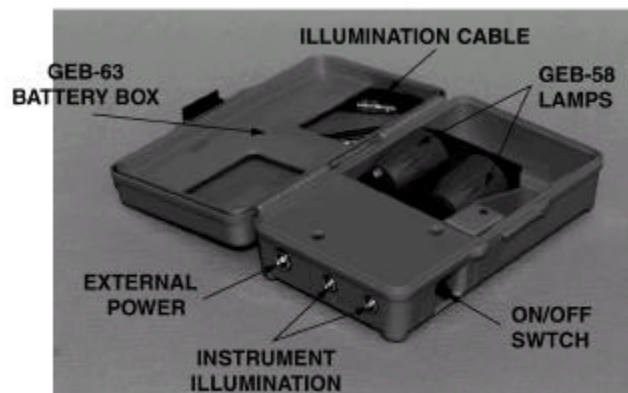

Figure 5-17. GEB-63 with Accessories.

The illumination kit is powered primarily by a 9 volt battery. Under normal conditions a new 9 volt battery will last up to 20 hours. Place the ON/OFF switch in the OFF position when power is not needed to prevent undue discharge and increase battery life. Remove the 9 volt battery for storage. A cable is available to provide external power from a GEB-70 NiCad battery.

Two GEB-58 plug-in lamps supply the illumination. These lamps plug in to the mirror sockets when the mirrors are removed. Each GEB-58 lamp has a rheostat that rotates to adjust brightness. They also contain high-performance light emitting diodes (LED) for uniform illumination of the circles and the field of view.

To attach the illumination kit before leveling the T-2E, remove the mirrors and plug in the lamps. Place the mirrors in the transportation case until replaced on the theodolite. Hang the battery box on a tripod leg.

Plug in one end of the GEV-34 cable into the coaxial socket on the lower part. Plug in the other end to one of the two small socket holes at the bottom of the battery box. Both ends of the cable are the same. Attach external power if needed.

Place the ON/OFF switch in the ON position. Adjust the illumination brightness with the rheostat knobs on the plug-in lamps.

Maintenance

Clean all lenses, mirrors, and bubbles with lens paper. Do not touch the lenses with your fingers. Wipe all paintwork with a dry, lint-free cloth. If needed, moisten the cloth with ether or alcohol; never use oil, benzene or water.

Carefully wipe a wet instrument with a dry, lint-free cloth. Let a wet instrument dry completely before returning it to the case. Never store a wet instrument in its case.

Keep the case clean inside and out. Remove the foam rubber inserts to clean.

When a large temperature difference exists between outside and storage temperatures, allow time for the instrument to obtain temperature equilibrium. This is necessary if full use of the instruments measuring accuracy is to be obtained. As a general rule, the time to obtain equilibrium corresponds to the temperature

difference in °C. In other words, if there is a 5°C difference between storage and outside temperatures, then allow 5 minutes.

The transportation case should not be used for storage of the T-2E. Store the theodolite outside the case so that air can flow around it. This helps to prevent mildew and fungus in both the T-2E and the case. Store the T-2E in an area as close to outside temperatures as possible to decrease the effects of steaming of the optics and condensation. Use a dehumidifier in humid climates.

Transport the T-2E in the foam rubber-padded transportation cases.

Test the T-2E on a quarterly basis. Adjust it only when needed. Keep a test and adjustment log with equipment records if possible.

Conduct calibration and repair through the survey instrument calibration program (SICP).

SECTION II. DI 3000 DISTOMAT

The DI 3000 is a timed-pulse electronic distance-measuring device. The time needed for a pulse of infrared light to travel to the reflector and back is measured. Depending on the measuring mode, the displayed result will be the mean of hundreds or even thousands of such measurements. The laser is listed as a Class 1 laser product meaning it is completely harmless.

Range and Accuracy

The maximum range depends on atmospheric conditions and prism configuration. Poor atmospheric conditions such as haze or bright sunlight will decrease its maximum ranges. Table 5-1 shows the typical ranges that can be expected with different target configurations and different atmospheric conditions using Wild (Leica) circular prisms.

Table 5-1. Typical Ranges.

Number of Prisms	ATMOSPHERIC CONDITIONS		
	Poor	Average	Excellent
	about	about	about
1	2.0 km	6 km	9 km
3	2.3 km	7 km	11 km
11	2.7 km	9 km	14 km

Poor: Strong haze with visibility about 3 km or very bright sunlight with severe heat shimmer.
Average: Light haze with visibility about 15 km or moderate sunlight with light heat shimmer.
Excellent: Overcast, no haze, visibility about 30 km, no heat shimmer.

Accuracy of the displayed distances depends on the operating mode. Standard deviation is listed at 3-5 millimeters +1 parts per million for all operating modes except the tracking mode (10 mm + 1 ppm). One parts per million equals 1 millimeter per kilometer measured. This means that with a distance of 10,000 meters in the normal mode, the standard deviation equals 13-15 millimeters.

Power Sources

The DI 3000 requires a 12 volt DC power source. Several sources of power are available. The GEB-70 is a 2 amp hour, 12 volt DC, Nickel-cadmium rechargeable battery. Fully charged it provides sufficient power to measure about 2000 distances. The GEB-70 has a clip on its side so it can hang on a tripod leg. It has a 2.5A fuse on its bottom to prevent damage to the battery and distomat. A 5-pin cable (GEV-52) connects the GEB-70 to the DI 3000. See figure 5-18.



Figure 5-18. GEB-70 NiCad Battery.

The battery has a nonconstant discharge rate. The battery discharges quickly between power indicators 9 to 7 and between indicators 3 to 1. It discharges slowly between power indicators 7 to 3. The power indicators are displayed on the DI 3000 Control Panel. When the battery voltage drops below 11.0V (power indicator 1), the distomat will not measure a distance. Error message 12 appears on the display. See figure 5-19.

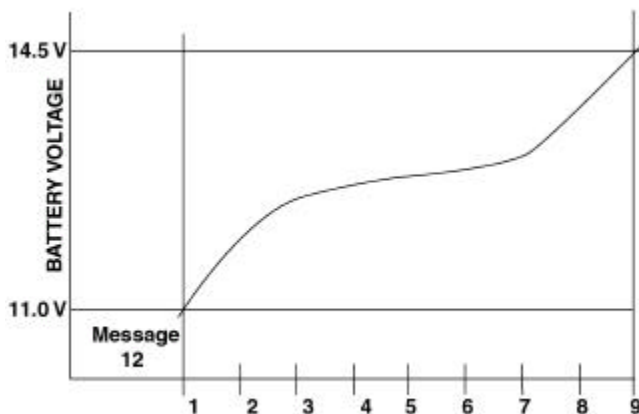

Figure 5-19. GEB-70 Discharge Rate.

The GEV-51 cable connects the DI 3000 to a 12 volt vehicle battery. One end has alligator clips for the battery terminals. The other end has a black box with a 2.5A fuse with two spares. The black box has a 5-pin connection for the GEV-52 power cable.

The GKL-12 battery charger can recharge two GEB 70 NiCad batteries at a time. It generally takes 14 hours to recharge a completely discharged battery. The charger plugs into a standard AC outlet and may be set for either 115 or 220 volts. When the batteries are connected, a red light illuminates on the charger. If no light appears, then the cables are not connected properly, no power is going to the charger or the fuse in the batteries are blown.

The charger has a built-in overload protection timer. With a battery connected, press the red button to start a 14-hour charge. If there is a break in the AC main supply, the timer restarts automatically. At the end of charging, it automatically switches off the power supply.

Mounting the DI 3000 to a T-2E

Before the DI 3000 can be mounted on a T-2E, the operator must ensure the theodolite has been properly modified. Modification includes adding an adapter plate to the reverse side of the telescope, adding a tension pin on the standard of the theodolite, and changing the spring in the vertical drive. See figure 5-20.

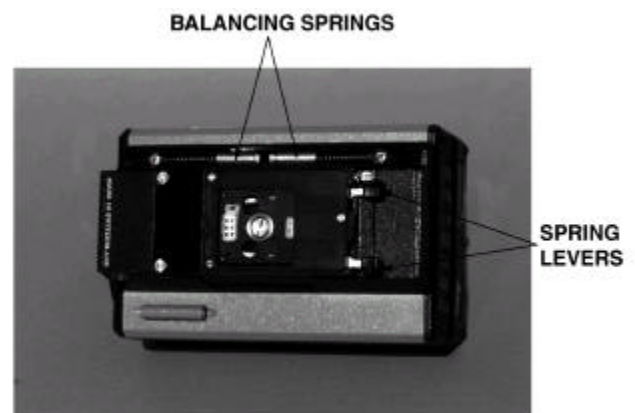

Figure 5-20. DI 3000 Bottom View.

Setup and plumb the tripod. Mount the theodolite on the tripod. Remove the carrying handle and lens cap from the theodolite. Place the telescope in the reverse position.

Attach the GEB-70 battery to the tripod leg. Do not disturb the plumb and level of the tripod. Holding the DI 3000 by the carrying handle, press the two spring levers at the keyboard end together with the other hand.

Place the DI 3000 over the telescope. Align the tension pin on the standard between the balancing springs on the distomat. Lower the distomat so that the holes in the base plate are aligned to the posts on the telescopes adapter plate. Release the two spring levers. Check to ensure the DI 3000 is properly seated. See figures 5-21 and 5-22.

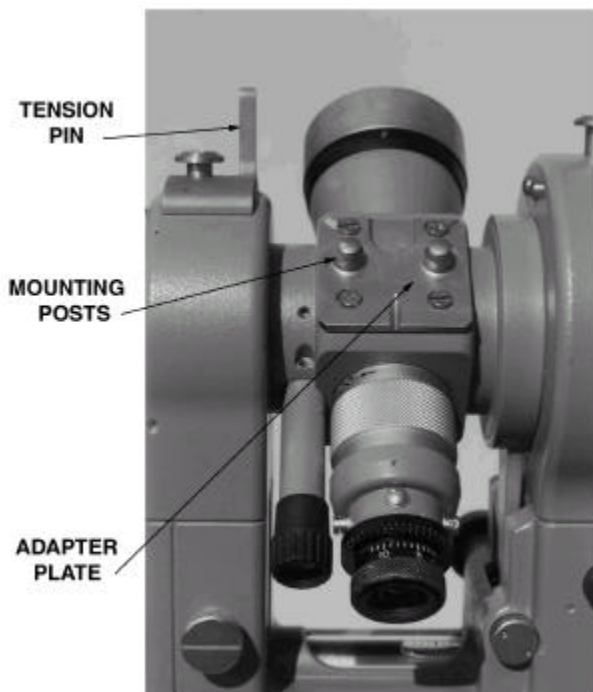

Figure 5-21. T-2E Modification for DI 3000.

Connect the large end of the GEV-52 cable to the GEB 70 battery or to the GEV-51 12v cable by aligning the red dots on the connectors. Connect the small end of the GEV-52 cable to the DI 3000 by aligning the red dots on the connectors.

Remove the lens covers from the front of the distomat and place them in the instrument case. Close the instrument case and place it out of the way. Plumb and level the theodolite.

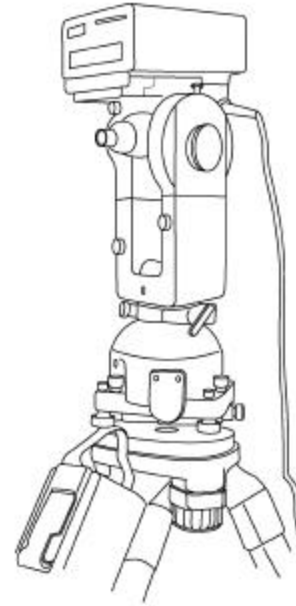

Figure 5-22. DI 3000 Mounted on T-2E.

Control Panel

All DI 3000 operations are performed using the control panel. It includes the signal strength indicator, the LCD display, and the keyboard. See figure 5-23.



Figure 5-23. DI 3000 Control Panel.

The signal strength indicator is located at the upper right corner of the control panel. When a signal is received from a prism set, the indicator illuminates in red. When a weak signal is received, the indicator illuminates to the left; when a strong signal is received, the indicator illuminates to the right. If no return signal is received, the indicator does not illuminate.

The DI 3000 is equipped with a seven-digit LCD that illuminates. The full distance is always displayed as well as symbols indicating operating modes and functions.

The keyboard is the operator's interface with the distomat. The keys have several functions as indicated by their colors. White keys are main commands, green keys are display settings, and orange keys are set and store parameters. The DI 3000 beeps with each keystroke unless that keystroke is out of sequence, illogical or is carrying out an operation.

Operation

Press the ON/OFF button to start. The LCD displays the stored ppm and prism constant. To turn off, press the ON/OFF button. By default, the DI 3000 switches off automatically 10 minutes after the last keystroke except when in the tracking mode.

The display field is illuminated from the back. To illuminate the display press the LAMP button. Press it again to turn off.

To display the LCD test and the battery power indicator, press and hold down the TEST button. The display check appears while the TEST button is pressed; when released the battery power indicator displays the battery voltage in terms of a value from 1 to 9. The DI 3000 sends out a signal to the prism set, the signal strength indicator illuminates, and a tone sounds. The STOP button cancels the tone. Press any command key to exit the test mode.

The CE key (CE, RUN, +/-) allows the operator to exit from a command while retaining the current setting. While inputting data the CE button clears the entry one figure at a time until RUN is touched. RUN completes entries and commands. Once RUN is touched, settings are made and their values stored. To enter values that require a negative, press the +/- key.

Use the STOP key to halt—

- Tracking in the track mode.
- The repeat mode.
- A normal measurement. This is necessary if the beam is interrupted by an object and the measurement cannot be completed.
- The tone in the test mode.

System Settings

Prism Constant (Millimeters)

The DI 3000 determines the distance to the center of the reflective surface of the prism. The surface position is offset differently depending on the type of prism used. If the measured distance is to be correct, the prism constant for the type of prism must be stored in the DI 3000. The prism constant must be entered in millimeters. Use the following settings:

- 0 millimeter for Wild circular prisms.
- -35 millimeter for Wild rectangular prisms.
- When using non-Wild prisms, determine the prism constant by measuring on an accurately known base line. To store the prism constant press SET, mm; enter the millimeter value; and press RUN.

Units

The DI 3000 can measure meters or feet. The unit of measurement that has been stored will be used until it is changed, even if turned off and then on again. An F (for feet) will appear in front of the ppm value on the display if feet are stored as the unit of measure. To set units, press SET, MODE. Enter 41. Press RUN. Enter 0 for meters, 1 for feet. Press RUN.

Decimal Fix

The number of digits displayed after the decimal point in a measured distance can be set from 0 to 4. This setting remains until changed. The displayed distances are as follows (n = number of digits after the decimal point):

n = 0	1m	1 ft
n = 1	0.1m	0.1 ft
n = 2	0.01m	0.01 ft
n = 3	0.001m	0.001 ft
n = 4	0.0001m	0.0001 ft

To set the number of digits after the decimal press SET, FIX; enter n.

Scale Correction (Parts Per Million)

The scale correction in parts per million applies proportionate corrections to a measured distance. The corrections negate the affects of atmospheric conditions, sea level reduction, and projection scale factor. The affects of atmospheric conditions are discussed in this paragraph. The affects of sea level reduction and projection scale factor are corrected in most survey computer systems and should not be used with the DI 3000.

Atmospheric conditions affect the speed of the infrared light that, in turn, affects the time for that light to travel to the prism and back. So the time to compute the distance is in error and a parts per million compensates for this. The conditions used to determine parts per million corrections are temperature, barometric pressure, and humidity.

Temperature and Barometric Pressure

Temperature and barometric pressure are generally considered together to produce a scale correction. The operators manual has a chart for figuring a parts per million from temperature and pressure. The DI 3000 allows the operator to enter that parts per million or can compute it from a user-entered pressure and temperature. Let the distomat compute the parts per million. Enter pressure in millibars, temperature in °Cs. Both methods are explained below.

To store the scale correction (parts per million)—

- Press SET, ppm.
- Enter the ppm value.
- Press RUN.

To enter and store pressure and temperature—

- Press SET, p/t.
- Enter the pressure (550 mb to 1050 mb).
- Press RUN.
- Enter the temperature (-99 to +99°C).
- Press RUN.

Relative Humidity

The influence of humidity on infrared light is very small. It needs only to be considered in hot regions, and if the most precise distance measurements are needed. The humidity value defaults to 60 percent when turned on. This default value is sufficient for all artillery survey applications. The atmospheric correction in ppm is calculated using the entered temperature, pressure, and humidity values. If the default value of 60 percent humidity is accepted, the error in the calculated atmospheric correction will never exceed 2 parts per million at 50°C. It will never exceed 0.5 parts per million at 20°C. To enter the relative humidity, press SET, MODE. Enter 45. Press RUN. Enter the humidity value in percent. Press RUN.

The DI 3000 does not store the humidity value when turned off. The default value of 60 percent is reset at turn-on and the parts per million displayed is recomputed using the default value.

Distance Measurement

Once the DI 3000 has been mounted on the T-2E and the theodolite is properly plumb and level, the operator must sight on the target. To measure a distance press ON. Enter the scale correction. Press TEST. If the signal strength indicator displays a sufficient return signal, the operator can measure the distance using one of four operating modes shown below. If the return signal strength is not sufficient to measure a distance, correct the parallelism of the distomat.

The normal (DIST) mode takes 3.5 seconds and has a standard deviation of 3 – 5 millimeters + 1 parts per million. Press DIST. Distance is measured and displayed. If the operator uses this mode, several distances must be measured and meaned. At least three distances must be measured.

The rapid (DI) mode takes 0.8 seconds and has a standard deviation of 5 millimeters + 1 parts per million. Press DI. The DI 3000 measures the distance and displays it. If the operator uses this mode, several distances must be measured and meaned. At least three distances must be measured. The primary difference between this mode and the normal mode is the listed

accuracy. This mode can also be used when heat-shimmer conditions prevent the user from measuring long distances with the normal and repeat modes.

The tracking (TRK) mode takes 0.8 seconds for the initial measurement followed by updates every 0.3 seconds. It has a standard deviation of 10 mm + 1 ppm. Press TRK. This mode sends a constant signal and continuously displays a new distance. It will mostly be used with stake out measurements but can be used during parallelism adjustments. This mode can drain batteries if not monitored because the automatic shut-off is disabled while tracking.

The repeat (DIL) mode takes 3.5 seconds for the initial measurement and repeats automatically. The display in the repeat mode alternates between the cumulative mean of all measurements on one display and the number of measurements taken (n) and the standard deviation (s) in millimeters of a single measurement on the next display. Press DIL. The instrument operator monitors the standard deviation as it falls and then levels out. Once the standard deviation levels out, press STOP. The cumulative mean of all distances is displayed. If the number of measurements and the standard deviation needs to be viewed, press DSP.

Interruptions in the beam of infrared light will not affect the result. If the beam is interrupted, the display shows from 1 to 6 bars. The bars indicate how far the measurement has progressed. One bar equals start of measurement; six bars equals end of measurement.

Short interruptions can be caused by air turbulence. Thus, long distance measurements may take slightly longer in heat-shimmer conditions. In the normal, rapid, and repeat modes, the measurement terminates automatically if the beam is interrupted for 30 seconds. In the tracking mode the tracking sequence starts again with an initial 0.8 second-measurement if the beam is interrupted for 0.5 seconds.

Parallelism: DI 3000 to Telescope

The infrared beam of the DI 3000 and the line of sight of the T-2E telescope should be parallel. The return signal strength is strongest when a proper pointing is

made at a target. If parallelism is not correctly adjusted, the return signal strength is weak or none at all.

Parallelism is normally adjusted at the distomat but the prism-target distance must be set for the type of theodolite. Prism-target distance is the distance from the center of the prism (GPR1) to the center of the optical sight on the target reflector (GRZ3). This distance must be set so that it equals the distance between the center of the objective lenses of the DI 3000 and the center of the telescope's objective lens. See figure 5-24.



Figure 5-24. Prism-Target Distance.

To set prism-target distance, use a jewelers screwdriver to drive the grub screw in the stem of the prism holder (GPH3Z) into the stem.

Slide the two stems of the prism holder into the target reflector so that the grub screw aligns with the 87 mm hole labeled for the T-2 theodolite.

Use the jewelers screwdriver to draw the grub screw out of the stem enough to keep the prism holder fixed in place in the target reflector.

Checking Parallelism

Check parallelism before starting a survey. The adjustment can be made anytime. To check the parallelism, set up the DI 3000. Set up a target at least 200 meters away with a clear line of sight.

Make a pointing on the target reflector. Press ON, TEST. If the signal strength indicator illuminates to the right of center, do not adjust. If the indicator illuminates to the left of center or not at all, adjust.

Adjusting Parallelism

If the procedures above indicate that a parallelism adjustment is needed, ensure the telescope of the T-2E is properly pointed on the target. Press TEST. View the optical sight located on the bottom right side.

Use the hex key to turn the horizontal and vertical adjustment screws to bring the white cross onto the prism. The signal strength indicator should illuminate towards the right and an audible tone will be heard. See figure 5-25.

Viewing the signal strength indicator, adjust the horizontal and vertical adjustment screws until the strongest return signal is achieved. Press STOP, OFF, ON, TEST.

The signal strength indicator should illuminate to the right and the audible tone should sound. Press STOP, OFF.

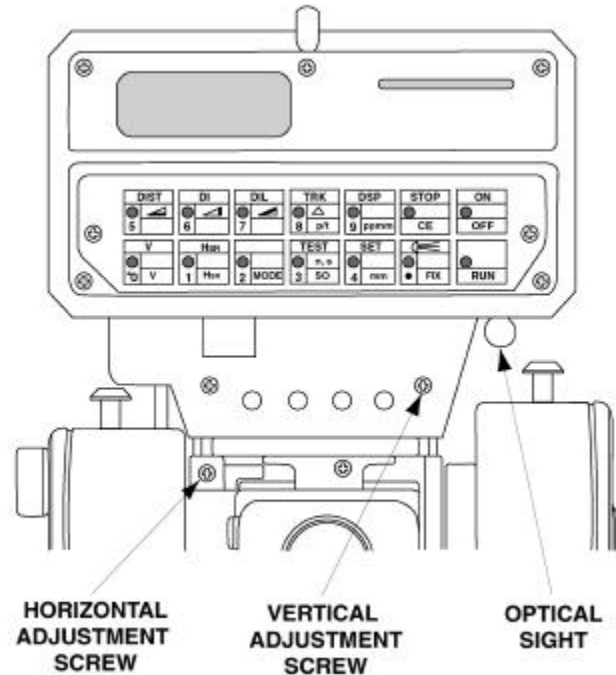

Figure 5-25. Adjusting Parallelism.

SECTION III. TARGET SET

The target set is a system that allows for forced centering over a station being used as a target for measuring angles and distances. It provides a rapid and accurate method of switching between target and theodolite and requires the tripod and tribrach to be setup only once. Referred to as the target set, it has a standard quick release mounting post. It holds the target plate, prism holders, or the MSGR 4000 (GPS-S) antenna with a quick release adapter. It has night lighting capability and is virtually waterproof.

Components

Tribrach (GDF22)

The tribrach for the target set is the GDF22 (the same tribrach used with the T-2E). The GDF22 mounts on

all tripods with a standard 5/8-inch fixing screw. It has three leveling knobs, a fish-eye level, and an optical plummet.

Target Carrier (GZR2)

There are two types of target sets: simple and precise. The difference is the target carrier. The GZR2 is used with the precise target set. It has a plate level for precise leveling-up. When properly adjusted, leveled, and mounted in a tribrach with a properly adjusted optical plummet, the target can be centered over the ground point to within 0.5 millimeters. The GZR2 is designed for use with the T-2E. It is placed in the tribrach and is locked in place by turning the swivel-locking knob on the side of the tribrach. See figure 5-26.

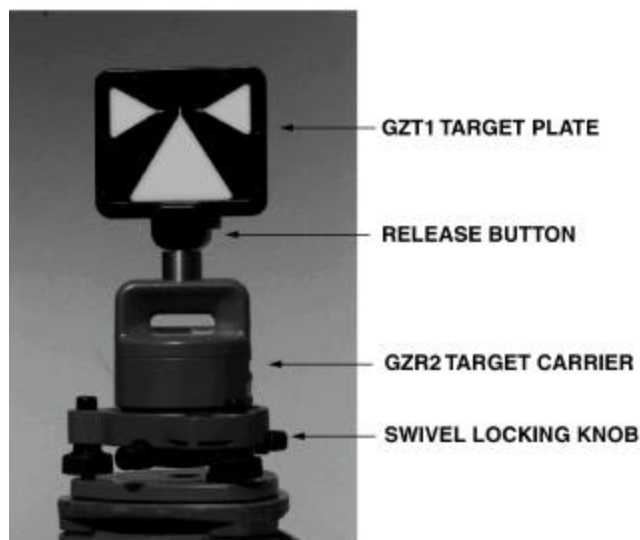

Figure 5-26. Target Set with Target Plate.

Target Plate (GZT1)

The target plate is fitted onto the target carrier by pressing the release button on the bottom side of the plate. It has a black and white target grid that creates reference marks for horizontal and vertical pointings. When fitted on the GZR2 carrier, the horizontal pointing marks of the target plate are the same height above the tribrach base as the T-2E tilting axis. The vertical pointing mark is aligned with the plumb line when the carrier and tribrach are properly adjusted and leveled. The target is generally observable in daylight at distances of over 1 kilometer. For longer distances, the GZT2 large target plate can be fitted onto the GZT1 target. The large target plate is not a component of the target set, but it is a component of the survey set. The GZT2 target allows sightings as long as 8 kilometers in good visibility conditions.

Illumination Kit

The illumination kit consists of a screw on reflector and a battery box. The battery box has an ON/OFF switch on the back of the case and is powered by two AA batteries. The bulb is screwed into the front side of the case and an extra bulb is inside. The reflector is screwed onto the case over the bulb and slides over the backside of the target plate (used with the GZT1 target only.) The target set holds the target plate GRZ3 with the triple prism

holder GPH3Z. The prism holder has a release button like the GZT1's target plate for mounting on the target carrier. When the prism holder is set for use with the T-2E theodolite, the horizontal pointing markers on the prism holder are the same height above the tribrach base as the T-2E tilting axis. See figure 5-27.

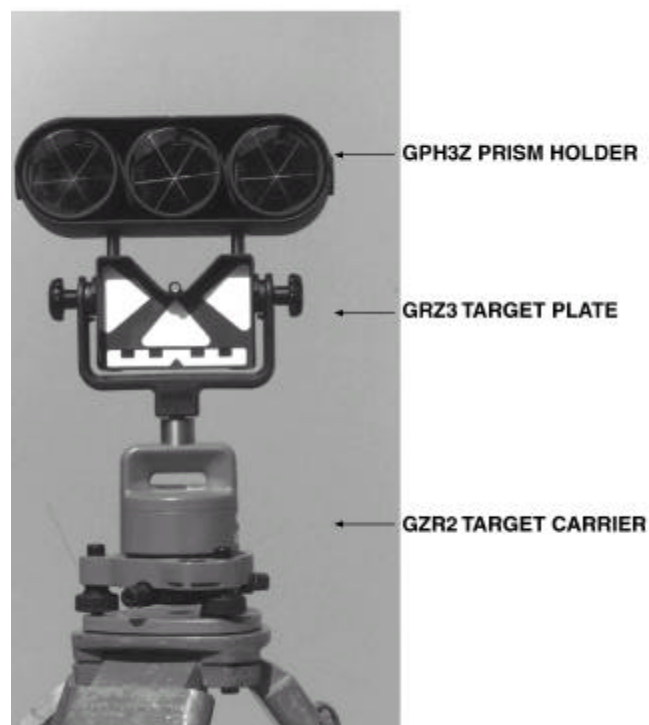

Figure 5-27. Target Set with GRZ3 and GPH3Z.

Mounting

Open the target set case. Carefully place the tribrach on top of the tripod. Keep one hand on the tribrach and attach the tribrach to the tripod head by screwing the fixing screw snugly into the base of the tribrach. Make sure the swivel-locking knob is open. Carefully place the target carrier into the tribrach. Rotate the swivel-locking knob clockwise one-half turn until the arrow points down and the carrier is secure.

Plumb and Level

Step 1. Loosen the fixing screw slightly and carefully slide the target set on the tripod head to center the point of the plumb bob exactly over the station.

Step 2. With one hand on the target set, tighten the fixing screw. Excessive tightening of the fixing screw will bend the tripod's slotted arm and damage the tripod head. Be sure the point of the plumb bob remains centered over the station. Remove the plumb bob and return it to its case.

Step 3. Rotate the target carrier until the axis of the plate level is parallel to any two of the three leveling screw knobs. Grasp the leveling screw knobs between the thumb and forefinger of each hand. Turn the knobs at the same time so the thumbs of both hands move either toward each other or away from each other. This movement tightens one screw as it loosens the other. The bubble always moves in the same direction as the left thumb. Center the bubble by using these two leveling screw knobs. This is the first position.

Step 4. Rotate the target carrier clockwise 1600 mils. This second position places the axis of the plate level at a right angle to the first position. Using the third leveling screw knob only, center the bubble.

Step 5. Rotate the target carrier clockwise 1600 mils so that it is 3200 mils from the first position. Level the target set using the same two leveling screws as were used in the first position. This is the third position.

Step 6. Rotate the target carrier clockwise 1600 mils so that it is 3200 mils from the second position. Level the target set using the same single leveling screw that was used in the second position, this is the fourth position.

Step 7. Repeat Steps 5 and 6 above until the bubble remains centered in both positions.

Step 8. Rotate the target carrier to the first position. If the bubble stays centered in this position, rotate the target carrier to the second position. If the bubble stays centered in this position, rotate the target carrier throughout 6400 mils. If the bubble stays centered, the instrument is level.

Step 9. If the bubble does not stay centered during the procedures in Step 8 but is within one graduation, level the instrument by bringing the bubble halfway back towards the centered position. If the bubble continues to move more than one graduation, adjust the level vial.

Step 10. After the instrument is level, check the optical plumb to make sure the target set is centered exactly over the station. If not, center the instrument over the station by loosening the fixing screw on the tripod and shifting the target set on the tripod head. Check the level of the target set. If necessary, repeat the leveling process and check the optical plumb again. Repeat this process until the target set is level and centered over the station. The optical plumb must be in proper adjustment. If not, the plumb bob may be a more accurate method of plumbing the instrument.

Mounting the Target Plate

Once the target set is plumbed and leveled, place the target plate on the carrier.

If using a GZT1 target plate, depress the release button at the bottom-side of the target plate. Carefully place the target plate over the target carrier mounting post. Orient the target towards the station that will be sighting on the target. Place the GZT2 large target plate or the illumination kit over the GZT1 target plate at this time.

If using the GRZ3 target plate with the GPH3Z triple prism holder, depress the release button at the bottom-side of the target plate. Carefully place the target plate over the target carrier mounting post. Orient the target towards the station that will be sighting on the target using the optical sight on the target plate. If needed, rotate the prisms vertically by loosening the screw knobs on the sides of the target plate and rotating the plate until the prisms are oriented towards the station. Tighten the screw knobs. After placing the target plate on the target carrier, verify the target set plumb and level.

Tests and Adjustments

The target set must be kept in correct adjustment to get accurate results. Test and adjust with the set mounted on its tripod. Set up the target set in the shade on firm ground with the head of the tripod as

level as possible. Protect the target set from the wind. When a test shows that an adjustment is needed, the operator adjusts and retests for accuracy before making the next test in sequence.

- Plate level.
- Circular bubble.
- Optical plumb.

Plate Level

This adjustment aligns the vertical axis of the target carrier to a line that is perpendicular to the geoid when the bubble of the plate level is centered in its vial.

Rotate the target carrier until the axis of the plate level is parallel with any two leveling screws. Center the bubble using those two screws. Rotate the target carrier clockwise through 1600 mils and center the bubble with the third leveling screw. Rotate the target carrier through 3200 mils. Noting the position of the bubble, use the third leveling screw to bring the bubble halfway back to its centered position.

Use an adjusting pin from the jewelers screwdriver with the T-2E theodolite to carefully turn the adjustment screw until the bubble is centered. The adjustment screw is located inside a small aperture at the base of the carrier.

Repeat these steps until the bubble remains centered within one graduation for all positions of the alidade.

Circular Bubble

This adjustment ensures that the vertical axis of the tribrach is aligned with the vertical axis of the target carrier. This is very important when taking the target carrier off the tribrach and replacing it with a T2-E theodolite.

To test, simply level the target carrier plate level to within one graduation of center. Then center or adjust the circular bubble.

On the GDF22 tribrach, two capstan screws are accessible via the side slits under the circular bubble. As either screw is loosened, the bubble runs towards it; as it is tightened the bubble runs away.

To adjust, use an adjusting pin provided in the jewelers screwdriver with the T-2E theodolite. Turn one of the two capstan screws until the bubble is located on a line between the center of the circle and the other screw.

Turn the other screw until the bubble is centered in the circle. Repeat if necessary. Do not turn the screws any more than is needed to adjust.

Optical Plumb

This adjustment makes the vertical axis of the GDF22 tribrach pass through the station mark when the target carrier is properly level and plumb.

The test requires that a target carrier be mounted in the tribrach. This is because leveling must be precise to test the optical plummet. The plate level of the target carrier must have been already adjusted to perform this test.

Set up and fine level the target set on a level tripod. Attach a plumb bob to the fixing screw.

Place a piece of paper or tape on the ground under the plumb bob. Use a fine tip pen to mark the plumb point on the paper. Rotate the plumb bob's bayonet plug and mark several positions through 6400 mils. Determine the center position of all the marks.

Remove the plumb bob. The tribrach should be optically plumb over the mark located in the center of the plumb bob marks. If not, adjust the optical plumb.

The optical plumb has two adjusting screws on the optical plumb arm under the tribrach. Look through the optical plumb. Use two jewelers screwdrivers to turn the adjustment screws in the direction shown in figure 5-15 on page 5-12 until the optical plumb is centered over the mark.

Maintenance

Clean the plate level and circular bubble with lens paper. If needed, moisten a cotton ball or swab with ether or pure alcohol. Never use liquids such as

benzene, oil or water. Do not touch the objective lenses with your fingers.

Wipe paintwork clean. If needed, use a cloth dampened with water. Never use liquids such as benzene.

Wipe a wet instrument carefully with a dry, lint-free cloth. Let the instrument dry completely before placing it in the case. Never store a wet instrument in its case.

Wipe cables clean with a damp cloth. If a connection or a cable plug is dirty, wash it in spirit and let it dry.

Keep the case clean inside and out. Keep the inside dry. If water gets in the case, wipe and leave open to dry.

Do not store the target set inside the shipping case. Remove the instrument from the case so that air can flow around it. This helps prevent mildew and fungus

in the case and instrument. Store the instrument in a low humidity, dust proof area.

Transport the target set in the foam rubber-padded transportation cases.

Test the target set quarterly. Adjustments made to a theodolite are useless if the target set is not properly adjusted.

Conduct calibration and repairs for the target set through the SICP.

To change the AA batteries in the illumination kit, unscrew the two screws on the backside of the battery box. Be careful not to pull the back off too far. A delicate cable inside the box only allows about 1-inch play.

CHAPTER 6. TRAVERSE

SECTION I. FUNDAMENTALS

Traverse is a conventional survey method that determines the position and elevation of the stations occupied by a survey team as well as the azimuth between those stations. Traverse can be used for all accuracy levels of artillery survey (fourth, fifth, and hasty). But in the chaotic and rapidly changing environment of the battlefield it may be too time consuming to perform at battalion and battery levels where accurate, timely direction is the most critical data needed to begin firing. Establishing a fourth order horizontal control by regiment surveyors is the most likely traverse operation to be conducted when other methods are not feasible. This chapter discusses fourth and fifth order survey methods. Hasty survey is discussed in chapter 10.

Traverse has several advantages over other conventional survey methods. It is well-suited for any terrain. Whether surveying in a forested area with 100-meter legs or a desert region with 12-kilometer legs, traverse is the preferred method.

Traverse allows a great deal of flexibility. If necessary, a survey plan can be easily modified while traversing. Often, a traverse can be laid out ahead of the instrument operator during the survey.

Traverse requires less planning and reconnaissance than other conventional survey methods. A traverse works similar to determining a polar plot grid from a map sheet. But instead of plotting the azimuth and distance, coordinates are plotted with plane trigonometry. See figure 6-1.

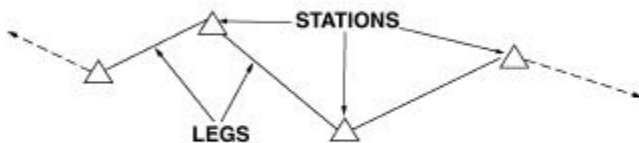

Figure 6-1. Traverse.

Open Traverse

This traverse begins at a point of known control and ends at a station whose relative position is known only by computations. It is the least desirable type of traverse because it does not check the accuracy of the control, field work or computations. Use open traverse only when time or the enemy situation does not permit closure on a known point. See figure 6-2.

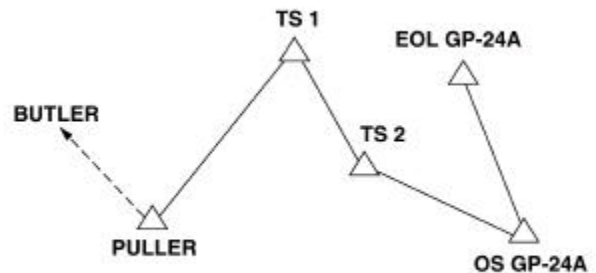

Figure 6-2. Open Traverse.

Closed Traverse

This traverse starts and ends at stations of known control. Because it provides a basis for comparison of computed data against known data, a closing accuracy can be determined.

Closed traverse on a second known point begins from a point of known control, moves through the various required unknown points, and then ends (closes) at a second point of known control, fourth order or higher.

This preferred type of traverse checks on field work, computations, and control. See figure 6-3.

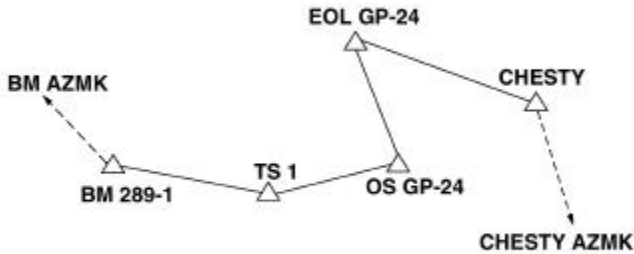

Figure 6-3. Closed Traverse on a Second Known Point.

Closed traverse on the starting point begins at a point of known control, moves through the various required unknown points, and ends (closes) at the same starting point. This type of traverse is more desirable than an open traverse but less than closing on a second known point. It checks field work and computations but does not check starting data accuracy or detect any systematic errors. See figure 6-4.

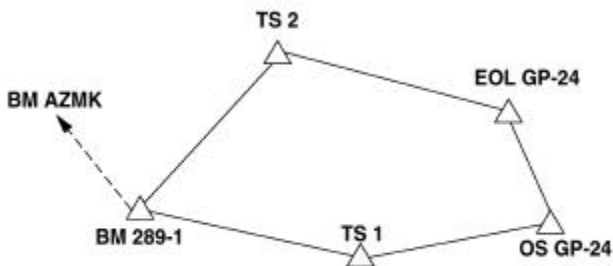

Figure 6-4. Closed Traverse on the Starting Point.

Directional Traverse

This traverse extends directional (azimuth) control only. It can be open or closed. If open, close the traverse at the earliest opportunity. Close on the starting azimuth or another known azimuth. Since direction is the most critical element of artillery survey

and time is an important consideration, sometimes lower echelons must assume battery location and extend direction only.

Sources of Control Data

Three elements of survey control must be known to start and close a traverse: the UTM grid coordinates and the elevation of a point and an azimuth from that point to a visible azimuth mark. See figure 6-5.

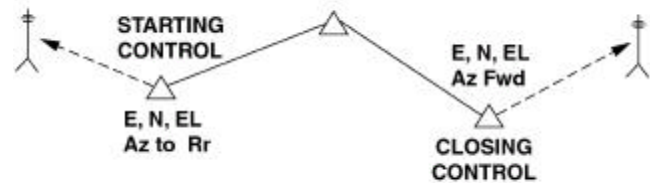

Figure 6-5. Starting and Closing Control.

Starting and closing data may be obtained from many different sources, but the two basic types of control are known and assumed.

Position and elevation may be acquired from trig lists of local or national survey agencies; e.g., NGS or NIMA or from supporting survey elements of a higher headquarters. An azimuth-to-an-azimuth mark may be determined from astronomic observation, computation from known coordinates or by reference to an existing trig list. Use an azimuth determined by a PADS two-position mark or PADS autoreflexion as a starting and closing azimuth for a fifth order traverse. An azimuth cannot be determined from computations between PADS points. PADS positions can be used for extending fifth order traverse, but the survey must be closed on the starting station.

If no known control is available, survey data may be obtained by assuming control (map spotting control through the best available resources). If any portion of starting control (coordinates, elevation, and azimuth) has to be assumed, the traverse must open and close on the same station.

Field Work

Traverse field notes are recorded in the current version of the field recorder's notebook.

Stations

In a traverse, three stations are of immediate significance: the rear, occupied, and forward. See figure 6-6.

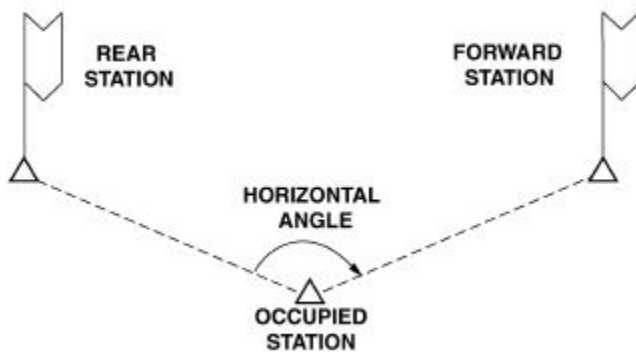

Figure 6-6. Rear, Occupied, and Forward Stations and Horizontal Angles.

The occupied station is where the theodolite is set up or occupies.

The rear station is where an azimuth from the occupied station is known or has been computed. It is the initial azimuth mark in a traverse or the occupied station during the previous angle.

The forward station is where the azimuth from the occupied station needs to be determined; it will be the next occupied station.

Measurements

At each occupied station (except the closing station) horizontal angles, vertical angles, and distance are measured. Only a horizontal angle is required at the closing station.

Horizontal angles are measured at the occupied station with a theodolite by sighting on the rear station and measuring the angle to the forward station. Horizontal angles determine the azimuth to the forward station. See figure 6-6.

Vertical angles are measured at the occupied station with a theodolite to the height of instrument at the forward station, usually a target set with a prism. Vertical angles are used primarily to determine the difference in height between the occupied and forward station. See figure 6-7.

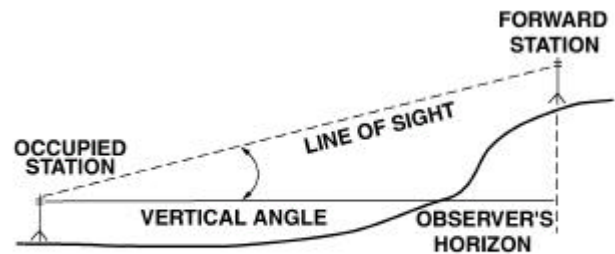

Figure 6-7. Vertical Angles.

When the distance between two successive stations in a traverse exceeds 1,000 meters, reciprocal vertical angles must be measured from each end of that particular traverse leg. This reciprocal measurement negates errors caused by the Earth's curvature and refraction. See figure 6-8.

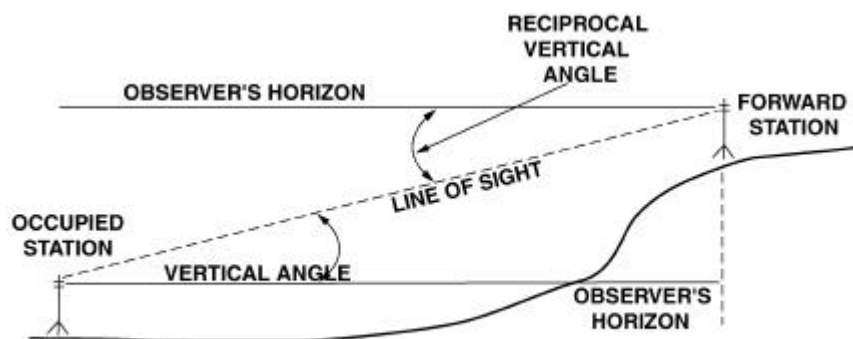

Figure 6-8. Reciprocal Vertical Angles.

The Earth curvature correction increases with distance. For example, at 1,200 meters, the correction is 0.1 meters; at 2,700 meters, 0.5 meters; and at 9,800 meters, 6.5 meters. It is easy to see that these corrections are substantial. If reciprocal vertical angles are not measured, these corrections will accumulate into very large errors.

Refraction varies depending on the Sun's altitude, temperature, and distance. It cannot be modeled like Earth curvature.

Some survey computer systems correct the vertical angle for Earth curvature if nonreciprocal vertical angles are measured, but not for refraction. A computer cannot determine its value with the data provided. Since this is only a partial correction, reciprocal vertical angles should be measured over all lines when time is available to negate the effects of refraction and Earth curvature. This is especially important during measurements in high heat shimmer conditions.

The distance between the occupied station and the forward station is measured by using electronic distance measuring equipment, horizontal taping or trig-traverse.

Distances

The distance that determines the coordinates of the forward station is not necessarily the distance measured. Slope, horizontal, and grid distances must be considered. See figure 6-9.

A slope distance is a straight-line distance between two stations that includes the effects of terrain. The straight-line distance between two stations of different elevations is longer than the distance between those same stations at equal elevations. Any distance determined by using electronic distance measuring equipment is a slope distance.

A horizontal distance is a straight-line distance between two stations, determined without the effects of terrain (the distance between the stations if they were both at the same elevation).

Any distance measured with a steel tape or determined through trigonometric computations is a horizontal distance.

A slope distance can be converted to a horizontal distance using the formula $\text{horizontal distance} = \cos(\text{vertical angle}) \times \text{slope distance}$.

The vertical angle should be the mean of the reciprocal vertical angles if the slope distance exceeds 1,000 meters. With most calculators, an angle must be in degrees to determine the trigonometric function of that angle.

A grid distance is the distance needed to compute the traverse leg. This distance is the same as a map distance. Determine a grid distance by reducing the horizontal distance to sea level. Then correct the sea level distance to grid by applying a scale factor correction.

If the horizontal distance was determined by horizontal taping, the correction for reduction to sea level is usually not applied. This type of distance is not accurate and is usually relatively short. Figure 6-10 shows that the correction for reduction to sea level increases as the elevation of the traverse lines increases.

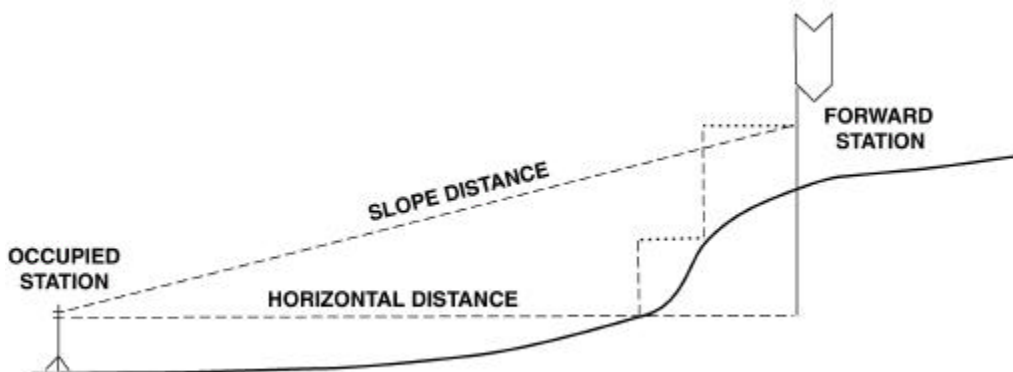

Figure 6-9. Slope and Horizontal Distances.

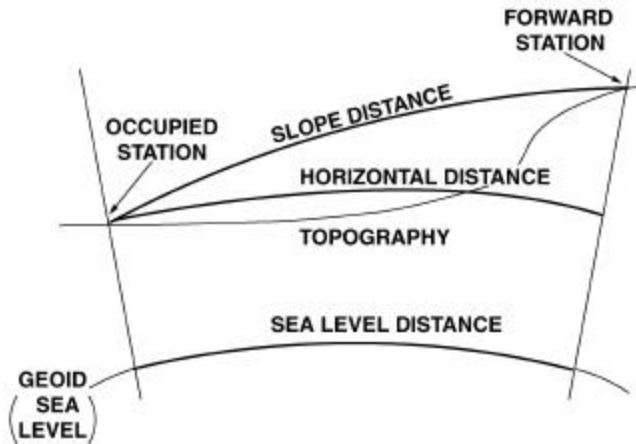

Figure 6-10. Reduction to Sea Level.

The reduction to sea level correction is negative when elevation is positive. The scale factor correction can be positive or negative depending on where the traverse line is with respect to the secant lines of the projection.

Since most survey computer systems apply the reduction to sea level correction to the horizontal distance automatically, the scale corrections (parts per million) for the DI 3000 must not include this correction.

Traverse Legs

A traverse leg is the line between two traverse stations. One end of the line is a point of known position (easting, northing, and elevation). The other end is a point requiring control. There are two types of traverse legs in artillery survey: main scheme legs and offset legs. See figure 6-11.

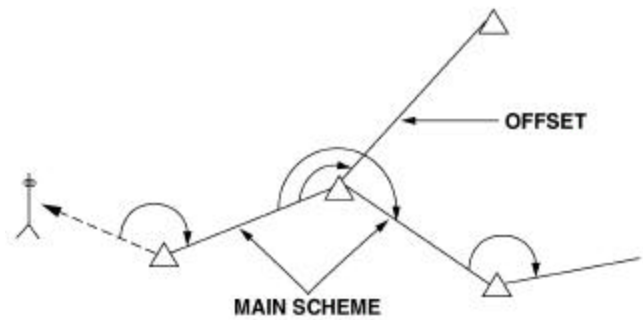

Figure 6-11. Traverse Legs.

A main scheme leg is one where both ends of the leg are an occupied station in the traverse. An offset leg is one where only the first station of the leg is occupied. The important difference is that an offset leg is left open (the coordinates and elevation determined for the offset station are not used in computations of other stations). Offset leg computations are performed before main scheme leg computations that originates from the same station.

The field data for the offset leg is measured and recorded during the same occupation as the main scheme data. The horizontal angle measured is called a multiple angle because it includes determining two horizontal angles from one set of observations. The vertical angle is determined the same way as with a main scheme leg including determining reciprocal vertical angles if the offset leg is longer than 1,000 meters.

SECTION II. FIELD NOTES

Survey Recorder Duties

The recorder's notebook is a legal document to document field notes during the course of field survey work. The recorder maintains the only

original record of field measurements and any occurrences that may affect those measurements. He must also be thoroughly trained in the requirements for all survey methods. Data recorded includes but is not limited to measurements, sketches, descriptions, and remarks.

Duties include—

- Records survey data neatly and legibly.
- Checks and means angular data.
- Records and means distances.
- Provides required data to the survey computers.

Horizontal angles, vertical angles, and distances from the instrument operator must be recorded. Sketches must be oriented with a north arrow and should be as close to scale as possible. In a long survey, the sketch may be separated over several pages.

Descriptions of stations to supplement the sketch should be written in the remarks section. Include distances from objects used to locate a station, type of marker, etc. Any changes to descriptions in a trig list should also be noted for submission to controlling agencies.

The remarks section should include any remarks that clarify survey data. Include descriptions of extreme weather phenomena and explanations of voided angles and pages. Some survey methods have required entries for the remarks section. These required entries are listed in the sections describing that method of survey. Temperature and pressure entries used as corrections for the DI 3000, instrument heights, and target heights should be included.

General Rules

Recording field notes is regulated by certain rules that apply to all methods. For the most part, these rules are designed for consistency between different recorders and to aid in the legibility and neatness.

Record all information in pencil. Keep the pencil sharpened to a fine point. Never erase in the notebook. Use only upper case letters. Do not slant letters and numbers nor strike over them. Use approved abbreviations and symbols. Use a straight edge and protractor for the sketch. Record directly into the

notebook. Never record into an extract or on paper and then transcribe recorded data to the recorder's notebook. Do not use pages of the recorder's book to perform math; use scratch paper.

Abbreviations that can be used are—

AZMK	Azimuth Mark
COP	Chief of Party
D	Direct
DIST	Distance
FWD	Forward
GN	Grid North
HI	Height of Instrument
HORZ	Horizontal
HT	Height of Target
IO	Instrument Operator
MN	Mean
OCC	Occupied
R	Reverse
RCDR	Recorder
READ	Reading
SCP	Survey Control Point
STA	Station
VERT	Vertical

Sometimes symbols need to be used, especially in the sketch. Generally, the symbols in the legend of a map sheet from the area of operations should be used. See figure 6-12.



Figure 6-12. Standard Symbols for Recording.

The first numbered page of the recorder’s book is the index. Page 1 includes the left and right sides. Heading and column blocks are set up as follows. See figure 6-13.

Fill in the designation block with the word “INDEX”.

Fill in the date block with the date the book was officially opened, usually the day the first survey in that book was performed.

Do not list any information in the heading blocks on the right side.

Label the column titles under the heading from left to right as—

1, PAGE. Identify the page number that includes a particular set of survey data.

2, DATE. List the date written in the date block of that page.

3, TITLE. List the designation written in the designation block of that page.

7, 8, and 9: Same as columns 1, 2, and 3.

Recording procedures for—

- GPS-S surveys and RTK/OTF are discussed in the 4000 MSGR job aids.
- Astronomic observations are discussed in chapter 7.
- PADS operations are discussed in chapter 8.

DESIGNATION: INDEX			DATE: 31 AUG 2000		
PAGE	DATE	TITLE			
1	-----	INDEX			
2	10 SEP 00	TRAVERSE			
3	10 SEP 00	TRAVERSE CONT			
4	5 OCT 00	TRIANGULATION			
5	5 OCT 00	TRIANGULATION CONT			
6	21 OCT 00	ARTY ASTRO			
7	6 NOV 00	3 POINT RESECTION			

Figure 6-13. Index Page.

Recording A One-Position Angle

This type of angle is used for fourth and fifth order traverse and most fifth order conventional methods and PADS autoreflection. See figure 6-14.

Heading and Column Titles

Fill in the designation block with the survey method being conducted; e.g., traverse. Fill in the date block with the date the field work was done.

Fill in column titles as—

- 1, STATION. Identify occupied, rear, and forward stations.
- 2, T. Identify the telescope position, direct (D), or reverse (R).
- 3, HORZ. Record horizontal readings measured at the occupied station and the mean horizontal angle used for computations.
- 4, MEAN. Record the mean of the direct and reverse horizontal readings at the forward and rear stations.

5, VERT READ. Record vertical readings measured by the IO.

6, VERT. \curvearrowright Record direct and reverse vertical angles calculated by the RCDR from the vertical readings and records the mean vertical angle used for computations.

7, SLOPE DIST. Record slope distances from the DI 3000. If only horizontal distances are measured, then title this column DIST.

8-12, REMARKS. Record any information about measurements and subsequent computations.

On the right side of figure 6-14, list weather conditions (left side of the top line). Use two words. The first word describes visibility; e.g., clear, sunny, cloudy; the second describes temperature.

List instrument types and serial numbers under weather conditions. This helps identify the instruments that may need adjustments due to errors.

List names of the COP, IO, and RCDR on the right side above the top line.

DESIGNATION: TRAVERSE				DATE: TODAY		CHIEF OF PARTY: SGT SMITH								
						INSTR OPR: LCPL BAKER 2								
						RCDR: CPL ADAMS								
						WEATHER: SUNNY, WARM								
						INST: T-2E #123456 DI 3000 #789123								
STATION	T	HORZ \curvearrowleft	MEAN	VERT READ	VERT \curvearrowright	SLOPE DIST	REMARKS							

Figure 6-14. Heading and Column Titles (One-Position Angle).

STA and T Columns

See figure 6-15. Fill out the T (telescope) column as shown.

Record the rear station (AzMk) name in the direct (D) mode row directly below the STA column.

Skip one line and record the occupied station name.

Skip one line and record the forward station name.

DESIGNATION: TRAVERSE				DATE: 21 DEC 2000	
STATION	T	HORZ \curvearrowleft	MEAN	VERT READ	VERT \curvearrowright
MCAS WT	D				
	R				
USMC 21	MN \curvearrowleft				
TS-1	D				
	R				

Figure 6-15. STA and T Columns.

Recording Field Data

Record field data in the columns and rows that correspond to the pointings. For example, when the instrument operator determines the initial circle setting, the T-2E is in the direct mode, pointed at the rear station. Determine the measurement from the

horizontal circle. Record the initial circle setting in the horizontal angle column in the direct mode row for the rear station. Figure 6-16 shows the standard order for measuring and recording a one-position angle. Figure 6-17 shows data recorded with means computed. Note that only data used by the computer is circled.

DESIGNATION: TRAVERSE						DATE: 21 DEC 2000						CHIEF OF PARTY: SGT SMITH					
												INSTR OPR: LCPL BAKER 2					
												WEATHER: SUNNY, WINDY					
												INST: T-2E #123456 DI 3000 #789123					
STATION	T	HORZ \curvearrowright	MEAN	VERT READ	VERT \curvearrowright	SLOPE DIST	REMARKS										
MCAS WT	D	1															
	R	6															
USMC 21	MN \curvearrowright																
TS-1	D	2		3		7											
	R	4		5		8											
						9											

Figure 6-16. Standard Order for Recording a One-Position Angle.

DESIGNATION: TRAVERSE						DATE: 21 DEC 2000						CHIEF OF PARTY: SGT SMITH					
												INSTR OPR: LCPL BAKER 2					
												WEATHER: SUNNY, WINDY					
												INST: T-2E #123456 DI 3000 #789123					
STATION	T	HORZ \curvearrowright	MEAN	VERT READ	VERT \curvearrowright	SLOPE DIST	REMARKS										
MCAS WT	D	0000.172															
	R	3200.286	0000.229														
USMC 21	MN \curvearrowright	0441.334			+55.746	347.115	OCC STA IS 2 M S OF MAIN ENTRANCE OF										
						347.109	BLDG 3040. REAR STA IS 50 M S OF SE										
TS-1	D	0441.556		1544.260	+55.740	347.120	CORNER OF BLDG 3040. FWD STA IS SW										
	R	3641.570	0441.563	4855.752	+55.752	347.115	CORNER OF PARKING SPACE.										

Figure 6-17. Example of a Completed One-Position Angle.

Recording A Two-Position Angle

This angle is required for certain fourth order methods such as triangulation and trig traverse. Use of this method for other survey methods is a matter of local SOP.

Heading and Column Titles

These are the same as for a one-position angle. See figure 6-18.

STA and T Columns

These are the same as for a one-position angle. The second angle starts two spaces below the first angle.

Recording Field Data

The first of the two measured angles is determined the same as a one-position angle. The second of the two

measured angles is the same as it is for a one-position angle except that the initial circle setting for the second angle will be 4800.000 mils (± 0.100 mils).

Vertical angles and distances are determined during the first-position angle. Determine the mean of the two-position angles by adding the two angles together; then divide that total.

When a two-position angle is observed, the two measured angles must agree within $+0.050$ mils. If they differ by more than 0.050 mils, reject and remeasure both angles.

Figure 6-18 shows data recorded with the means computed. The mean horizontal angle of each position angle is recorded in parentheses. The mean of the two position angles is circled.

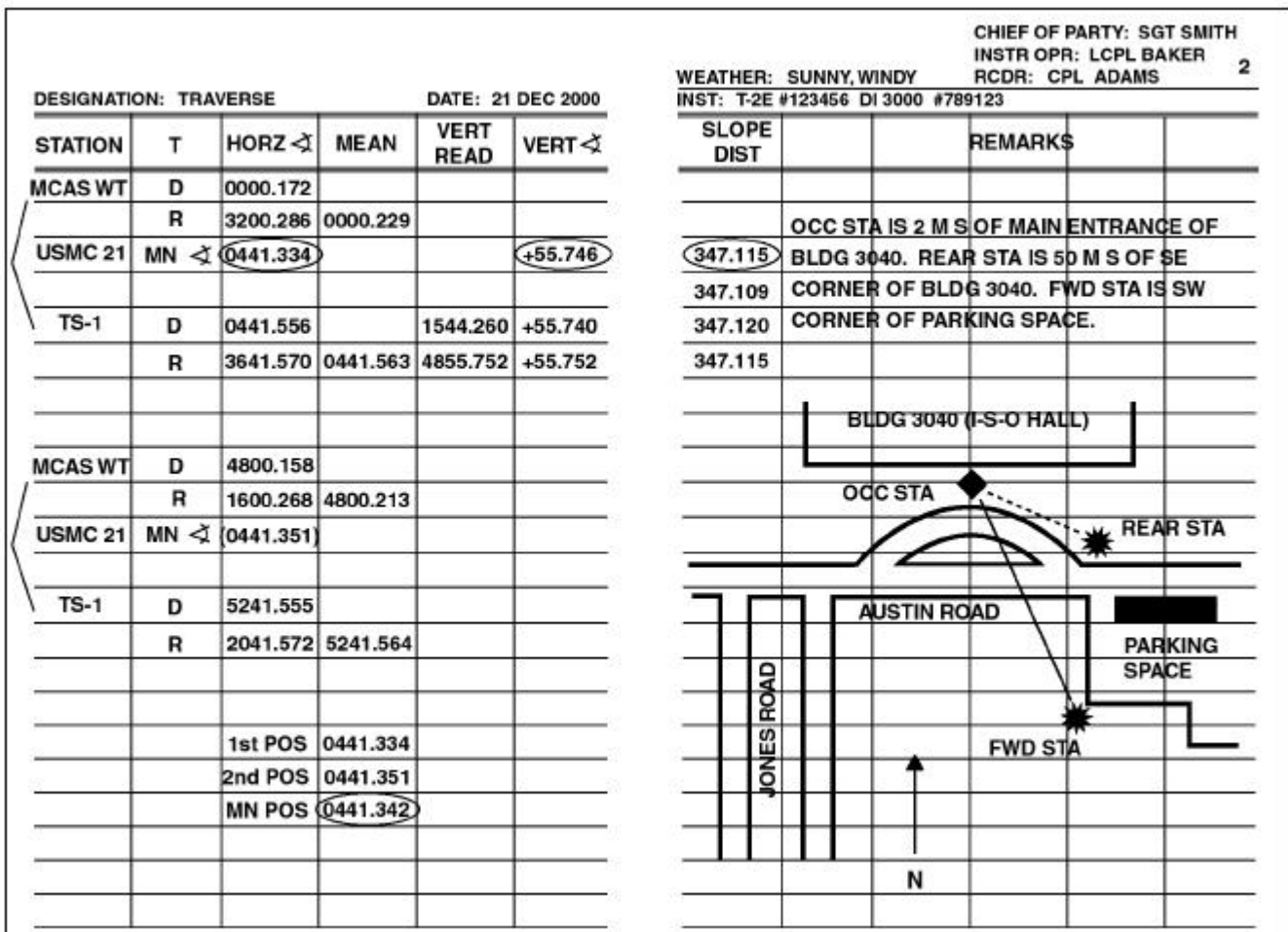

Figure 6-18. Example of a Completed Two-Position Angle.

Closing an Angle on the Horizon

See figure 6-19.

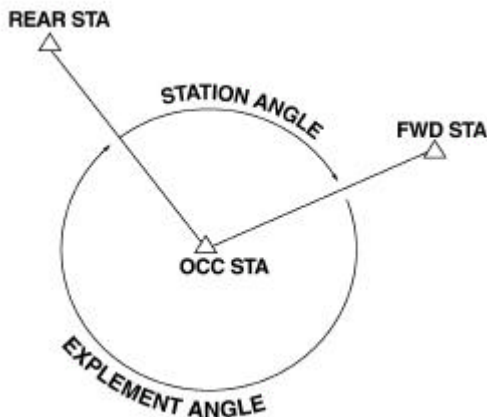

Figure 6-19. Angle Closed on the Horizon.

Use this angle when a two-position angle is required or as local SOP directs. Closing on the horizon means that the second angle measured closes a horizontal circle at 6400 mils. The first angle is the station angle; the second the explement angle.

Heading and Column Titles

These are the same as for a one-position angle.

STA and T Columns

These are the same as for a one-position angle. The explement angle starts two spaces below the position angle.

Recording Field Data

Figure 6-20 shows an example of data recorded with the means computed. Note that the mean horizontal

DESIGNATION: TRAVERSE						DATE: 21 DEC 2000					
STATION	T	HORZ	MEAN	VERT READ	VERT						
MCAS WT	D	0000.172									
	R	3200.286	0000.229								
USMC 21	MN	(0441.334)			(+55.746)						
TS-1	D	0441.556		1544.260	+55.740						
	R	3641.570	0441.563	4855.752	+55.752						
TS-1	D	0000.158									
	R	3200.268	0000.213								
USMC 21	MN	(5958.682)									
MCAS WT	D	5958.844									
	R	2758.946	5958.895								
		STA	(0441.334)								
		EXP	(5958.682)								
		SUM	6400.016								
		CIRCLE ERR	+0.016								
		POS COR	-0.008								
		COR POS	(0441.326)								

SLOPE DIST		REMARKS	
		OCC STA IS 2 M S OF MAIN ENTRANCE OF	
347.115		BLDG 3040. REAR STA IS 50 M S OF SE	
347.109		CORNER OF BLDG 3040. FWD STA IS SW	
347.120		CORNER OF PARKING SPACE.	
347.115			

Figure 6-20. Example of an Angle Closed on the Horizon.

angle of each measured angle is recorded in parentheses. The corrected station angle is circled. The station angle is determined the same as a one-position angle. The explement angle is the same as for a position angle except the rear and forward stations are reversed to measure the rest of the horizontal circle.

Determine vertical angles and distances with the station angle. Determine the mean horizontal angle by applying half of the error (from 6400 mils) to the station angle. When an angle closed on the horizon is observed, the sum of the two measured angles must be within ± 0.050 mils of 6400 mils. If the sum differs

from 6400 by more than 0.050 mils, both angles must be rejected and remeasured.

Recording Reciprocal Vertical Angles

When conducting a fourth order traverse or surveying a traverse leg of more than 1,000 meters, measuring reciprocal vertical angles is required. Heading and column titles (columns 1-6) are the same as for a one-position angle. Columns 7-12 are discussed below. See figure 6-21.

DESIGNATION: TRAVERSE						DATE: 21 DEC 2000		CHIEF OF PARTY: SGT SMITH INSTR OPR: LCPL BAKER RCDR: CPL ADAMS 2												
WEATHER: SUNNY, WINDY						INST: T-2E #123456 DI 3000 #789123														
STATION	T	HORZ \angle	MEAN	VERT READ	VERT \angle	MN RECIP VERT \angle	SLOPE DIST	REMARKS												
					(+5.657)															
USMC 21	D	0000.172		1594.365	+5.635															
	R	3200.286	0000.229	4855.752	+5.679															
TS-1	MN \angle	0441.334			+55.746															
TS-2	D	0441.556		1544.260	+55.740															
	R	3641.570	0441.563	4855.752	+55.752															
					(-55.699)															
TS-1	D	0000.158		1655.711	-55.711															
	R	3200.268	0000.213	4744.313	-55.687															
TS-2	MN \angle	4456.351			(-12.058)															
NOAH	D	4456.555		1612.090	-12.090															
	R	1256.572	4456.564	4787.974	-12.026															
					(+12.087)															
TS-2	D	0000.135		1587.901	+12.099															
	R	3200.179	0000.157	4812.075	+12.075															
NOAH	MN \angle	3438.118			(-68.257)															
MOSES	D	3438.293		1668.300	-68.300															
	R	0238.257	3438.275	4731.786	-68.214															

Figure 6-21. Example of Recording with Reciprocal Vertical Angles.

Column 7, MN RECIP VERT. Record the mean of the reciprocal vertical.

Column 8, SLOPE DIST. Record slope distances from the DI 3000. If only horizontal distances are measured, this column will be titled DIST.

Columns 9-12, REMARKS. Record any information pertinent to the measurement and subsequent computations.

STA and T Columns are labeled the same as for a one-position angle. However, if the top angle on the page includes a vertical angle to the rear station, the first row below the column titles will be skipped.

Vertical angles are measured to the rear station the same as they are to the forward station. Vertical readings are measured and recorded when the horizontal readings are made (the vertical reading to the rear station in the direct mode is made directly after the initial circle setting is recorded).

Vertical angles determined by the recorder that will be included in the mean of reciprocal vertical angles will be recorded in parentheses. The mean of the reciprocal vertical angles will be circled and recorded in column 7 in the row corresponding to the mean angle at the occupied station.

Recording Angles From an M2A2 Aiming Circle

These angles are generally used for hasty survey purposes. Hasty survey is discussed in chapter 10. As with all field notes, the first page of the notebook is the index.

Heading and Column Titles

Fill out as described below. See figure 6-22.

DESIGNATION: HASTY TRAVERSE						DATE: 11 APRIL 2000																													
STATION						R						HORZ \leftarrow						VERT \leftarrow						CORR						CORR VERT \leftarrow					
WEATHER: SUNNY, WARM												CHIEF OF PARTY: SGT JONES																							
INST: M2A2 43210												INSTR OPR: LCPL MILLER 2																							
SUBT												REMARKS																							
DIST																																			

Figure 6-22. Heading and Column Titles (M2A2 Angles).

Fill out the designation block with the survey method being conducted; i.e., hasty traverse. Other entries may be included after the method of survey.

Fill out the date block with the date the field work was performed.

Fill out the heading of the right side of the page as follows:

List weather conditions at the left side of the top line. Use two words; e.g., clear, warm.

List instrument types and serial numbers on the left side of the second line of the header.

List the COP, IO, and RCDR at the right side of the right page, above the top line.

Fill in column titles as follows:

1, STA. Identify the occupied, rear, and forward stations.

2, R. Identify the reading.

- 3, **HORZ.** Record the horizontal readings and the mean horizontal angle.
- 4, **VERT.** Record the uncorrected vertical angle to the forward station.
- 5, **CORR.** Record the vertical angle correction determined during operator tests.
- 6, **CORR VERT.** Record the corrected vertical angles and the mean corrected vertical angle.
- 7, **SUBT DIST.** Record the subtended distance as extracted from the subtense tables in FM 6-50 and the XO's handbook. This column may also be labeled for

the subtended angle or horizontal distance if taped or paced.

8-12: **REMARKS.** Record any information pertinent to the measurements and subsequent computations.

STA and R Columns

Fill out these columns as shown in figure 6-23. Record the rear station name directly below the STA column title. Record the occupied station name directly below the rear station. Record the forward station name directly below the occupied station. Record a "1" in the row directly below the "R", a "2" below the "1", and "MN" directly below the "2".

DESIGNATION: HASTY TRAVERSE						DATE: 11 APRIL 2000					
STATION	R	HORZ \angle	VERT \angle	CORR	CORR VERT						
EOL1	1	1469.5	-25.5	+0.6	-24.9						
OS1	2	2939.5	-25.0	+0.6	-24.4						
TS1	MN	1469.8			-24.6						
OS1	1	3864.0	+3.0	+0.6	+3.6						
TS1	2	1328.5	+3.0	+0.6	+3.6						
OS2	MN	3864.2			+3.6						

CHIEF OF PARTY: SGT JONES											
WEATHER: SUNNY, WARM						INSTR OPR: LCPL MILLER					
INST: M2A2 43210						RCDR: CPL CLARK					
						2					
SUBT DIST						REMARKS					
154							SUBTENDED DISTANCES DETERMINED FROM FM6-50 USING M-16A2.				
102											

Figure 6-23. Example of Recorded Data for a Hasty Traverse.

Recording Field Data

Record the horizontal, vertical, and subtended angles to the nearest 0.5 mils.

Record a subtended distance directly from FM 6-50 or the XO's handbook.

Record the mean horizontal angle to the nearest 0.1 mil.

If the second reading is greater than the first reading, compute the mean horizontal angle by dividing the second reading by 2. The mean horizontal angle is circled.

If the second reading is less than the first reading, compute the mean horizontal angle by adding 6400

mils to the second reading, then divide by 2. The mean horizontal angle is circled.

The mean horizontal angle must match the first reading within + 0.5 mils. If not, void the angle and remeasure.

Recording Intersection Method

The intersection method is the preferred way to determine target location when the target cannot be occupied. Follow the procedures below when computation of the target location is performed with azimuths measured to the target vice horizontal angles.

Fill out the heading and column titles as described below. See figure 6-24.

Fill out the designation block with the survey method.

Fill out the date block with the date the field work was performed. Fill out the heading of the right side of the page as follows:

List weather conditions at the left side of the top line. Use two words. The first word describes visibility; e.g., clear, sunny or cloudy. The second is a description of temperature.

List the instrument types and serial numbers on the left side of the second line of the header.

List the COP, IO, and RCDR at the right side of the right page, above the top line.

Fill in column titles as follows. See figure 6-25.

1, OCC STA. Identify the occupied stations.

2, AZ TO AZMK. Record the computed azimuth to the rear station. This is the azimuth set on the horizontal scale of the aiming circle.

3-5, TARGET DESCRIPTION. Identify the target and fwd station.

6, AZ TO TGT. Record the measured azimuth to the target.

7, VERT. Record the vertical angle to the target.

8-12, REMARKS. Record any information pertinent to the measurements and subsequent computations.

Record the azimuth to the azimuth mark to the nearest 0.5 mils. Record the azimuths and vertical angles to the targets to the nearest 0.5 mils. The target description should be adequate for another observer to identify that particular target.

DESIGNATION: INTERSECTION				DATE: 21 DEC 2000				CHIEF OF PARTY: SGT JONES			
								INSTR OPR: LCPL MILLER 2			
								WEATHER: SUNNY, WARM			
								INST: M2A2 43210			
OCC STATION	AZ TO AZMIK	TARGET DESCRIPTION			AZ TO TGT			VERT \angle	REMARKS		

Figure 6-24. Heading and Column Titles (Intersection).

DESIGNATION: INTERSECTION				DATE: 21 DEC 2000				CHIEF OF PARTY: SGT JONES			
								INSTR OPR: LCPL MILLER 2			
								WEATHER: SUNNY, WARM			
								INST: M2A2 43210			
OCC STATION	AZ TO AZMIK	TARGET DESCRIPTION			AZ TO TGT			VERT \angle	REMARKS		
OP 15	1825.5	TANK W/ TURRET FACING SO			4676.0			-12.5			
		APC ON E-W RIDGE FACING NO			4785.5			-5.0			
		POL SITE			4521.0			+3.0			
		RUNWAY W/ ATTITUDE 2800 MILS			3987.0			-9.5	CENTER OF RUNWAY		

Figure 6-25. Example of Completed Intersection Method (M2A2).

Correcting Errors and Voiding

The recorder must make entries small enough that if an error is made in the data, there is enough room left in the block to write the correct data. When a value is recorded incorrectly, the value is lined out with a single straight line and the correct value written above. Do not erase errors in the notebook.

A partial void voids an area of a recorder's page. This is usually done over a single angle. Include the reason for the partial void in the remarks section. A partial void is performed by sketching an "X" over the area to be voided, using a straight edge, and writing "VOID" over the "X". See figure 6-26.

A full-page void voids every entry made on a recorder's page. This is usually done when voiding

two-position angles, angles closed on the horizon, and astronomic observations. These methods all require the use of the entire page. Include the reason for the void in the remarks section. A full-page void is performed by sketching an "X" over each page, using a straight edge, and writing "VOID" over the "X" on each page. See figure 6-27.

Security

The notebook could provide the enemy with a large amount of valuable information should it fall into his hands (firing positions, radar sites, met sites, OPs, etc.). It could also provide names of personnel, equipment types, locations of survey control points, and other information that can be used for intelligence purposes.

DESIGNATION: TRAVERSE						DATE: 21 DEC 2000					
STATION	T	HORZ	MEAN	VERT READ	VERT						
MCAS WT	D	0000.172									
	R	3200.286	0000.229								
USMC 21	MN	0441.334			+55.746						
TS-1	D	0441.556		1544.260	+55.740						
	R	3641.570	0441.563	4855.752	+55.752						
VOID											
MCAS WT	D	0000.152									
	R	3200.354									
USMC 21	MN				+55.746						
TS-1	D	595		1544.260	+55.740						
	R	5841.570	2641.563	4855.752	+55.752						

SLOPE DIST		REMARKS			
		OCC STA IS 2 M S OF MAIN ENTRANCE OF			
347.115		BLDG 3040. REAR STA IS 50 M S OF SE			
347.109		CORNER OF BLDG 3040. FWD STA IS SW			
347.120		CORNER OF PARKING SPACE.			
347.115					
		SECOND ANGLE VOIDED DUE TO			
		EXCESSIVE ANGLE CLOSURE.			

Figure 6-26. Example of a Partial Void.

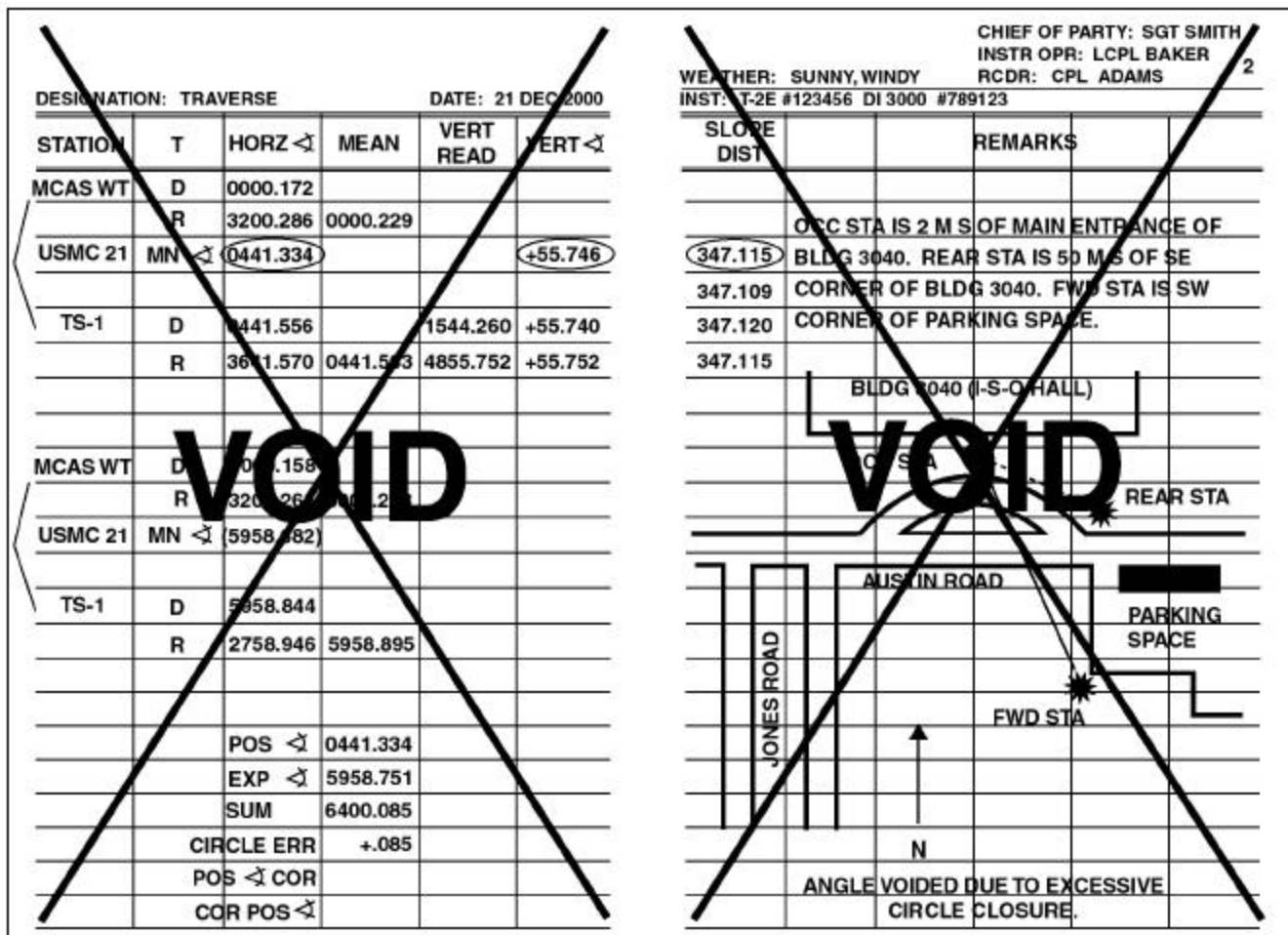

Figure 6-27. Example of a Full-Page Void.

In a contingency situation, the notebook must be safeguarded from the enemy. Some information could be classified; e.g., OS or survey control point coordinates. Therefore, the book becomes classified. When the threat of capture becomes imminent, a decision must be made as to the disposition of the notebook. If the capture cannot be avoided, destroy the notebook.

Storing the Recorder's Book

Use the notebook until filled. Then properly store it to eliminate damage. The storage area must be dry and safe from accidental damage such as spills. Maintain

the notebook for at least the minimum times as discussed below.

Notebooks with information used in establishing permanent control must be maintained for at least as long as those control points are in tact or until they are resurveyed.

Notebooks with information used in establishing nonpermanent control must be maintained for at least the same amount of time as position safety, per local SOP.

Notebooks may be maintained for archive purposes. If a unit establishes survey control (permanent or nonpermanent) in an area that is not used very often or not used before, the notebook could include information for planning future operations in that area.

SECTION III. TRIGONOMETRY

Extending Azimuth

An azimuth is the clockwise angle from a known reference line to a second line. For artillery survey purposes, the reference line is grid north and the second line is the traverse line to the forward station. Every line has a forward azimuth and a back azimuth. In artillery survey, we consider the Earth to be a flat surface. A forward azimuth and back azimuth differ exactly 3200 mils. See figure 6-28.

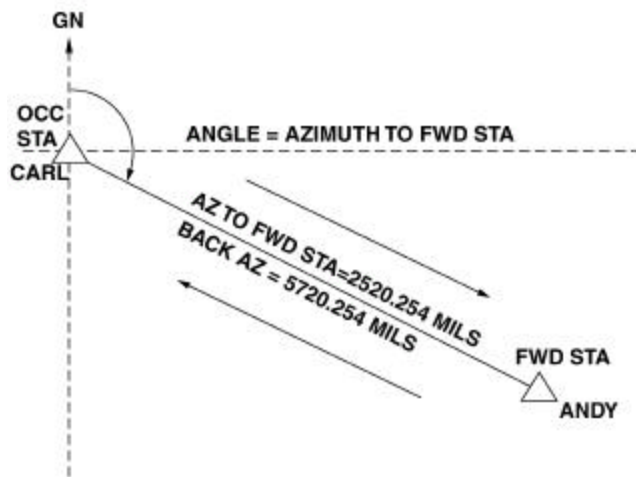

Figure 6-28. Azimuth.

Azimuth-Angle Relationship

When traverse computations begin, the only known azimuth is the azimuth from the occupied station to the rear station. To determine the azimuth to the forward station, add the horizontal angle measured at the occupied station to the azimuth to the rear station. See figure 6-29.

Sometimes the sum of the azimuth to rear and the horizontal angle produces an azimuth larger than 6400 mils. Subtract 6400 mils from that sum to determine the azimuth necessary for computations.

Azimuth to the Rear

Once the azimuth to the forward station is determined, the computations necessary to determine the coordinates of the forward station can be made. The extension of the survey beyond that point requires that the azimuth to the rear be determined from the azimuth to the forward station, as determined above. To do this, apply 3200 mils to the forward azimuth as shown in the following example:

Az to Fwd Sta (Carl to Andy):	2520.254 mils
<u>+3200 mils</u>	<u>3200.000 mils</u>
Az to Rear (Andy to Carl)	5720.254 mils

The azimuth to the forward station (Andy) from Carl is 2520.254 mils. This azimuth is used to compute the coordinates of Andy. To determine the coordinates of the forward station when Andy is occupied, the azimuth from Andy to the rear station (Carl) must be known. In the example it is 5720.254 mils.

Solutions of Right Triangles

Simple plane trigonometry can be used to compute a survey. The solution of two right triangles is necessary to determine differences in coordinates and elevation.

Forming the Coordinate Triangle

The distance and azimuth between two points can be used to form a right triangle. The grid distance between the traverse stations is the hypotenuse of the right triangle. The other two sides of the triangle are the easting and northing coordinate differences between the stations. The difference easting (dE) and difference northing (dN) are the unknowns that are determined by solving the right triangle. See figure 6-30.

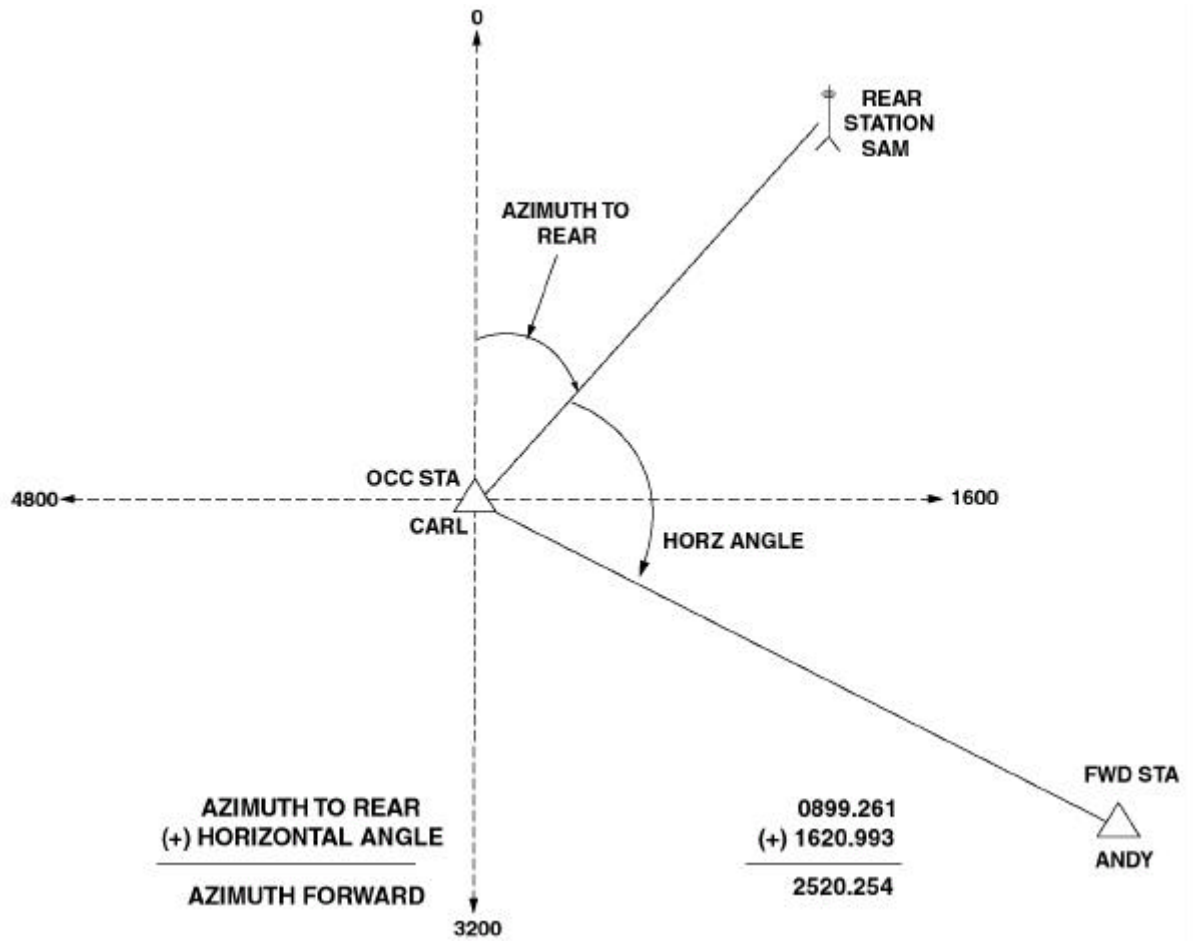

Figure 6-29. Azimuth-Angle Relationship.

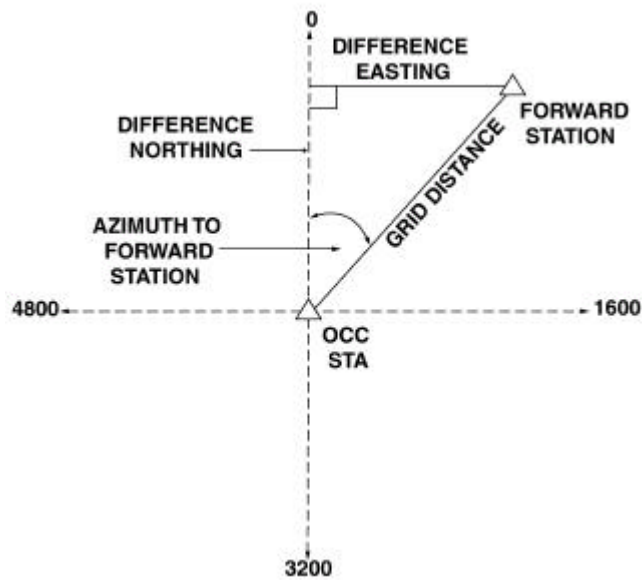

Figure 6-30. Coordinate Triangle.

Forming the Elevation Triangle

The distance and vertical angle between two points can be used to form a right triangle. The sides of the triangle forming the right angle are the grid distance

and the elevation difference between the stations (dH). The vertical angle is the angle formed by the grid distance and the line of sight (the hypotenuse). It is opposite the vertical interval. See figure 6-31.

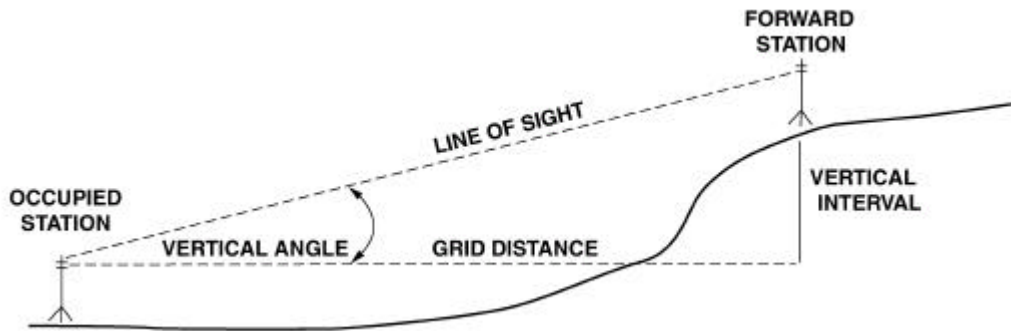

Figure 6-31. Elevation Triangle.

Trigonometric Functions To Compute a Traverse

Sine (sin) and cosine (cos) compute the differences in easting and northing coordinates. Tangent (tan) computes the difference in height.

The values of sin and cos are the distances corresponding to an angle formed at the center of a circle whose radius is one. Figure 6-32 shows that in a

circle of radius 1, the length of side dE is the sin of 849 mils (47.75625°) and the length of side dN is the cos of 849 mils. If you were to use a scientific calculator to determine the sin of 47.75625°, the answer would be 0.74029 and the cos would be 0.67229.

The value of tan equals the value of sin divided by the value of cos.

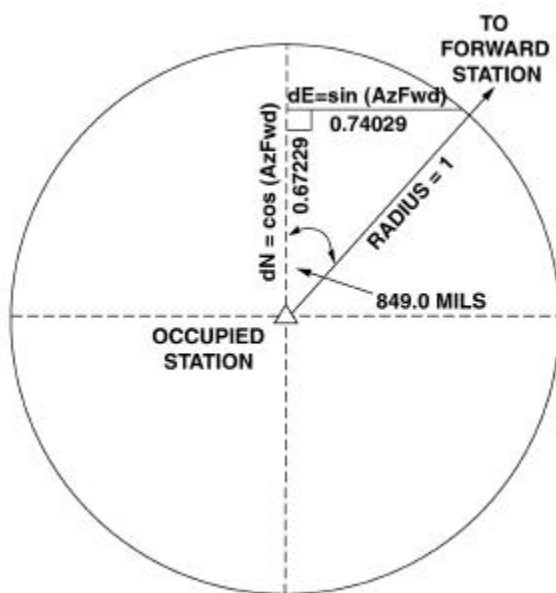

Figure 6-32. Value of Trigonometric Functions of Angles.

Determining Coordinate and Elevation Differences

See figure 6-33. The formulas for solving a right triangle are generally written as—

$$\sin (\text{angle}) = \frac{O}{H}$$

$$\cos (\text{angle}) = \frac{A}{H}$$

$$\tan (\text{angle}) = \frac{O}{A}$$

whereas: O is the side opposite the angle

A is the side adjacent the angle

H is the hypotenuse

and: Angles are converted to degrees from mils using the formula degrees = mils \times (0.05625).

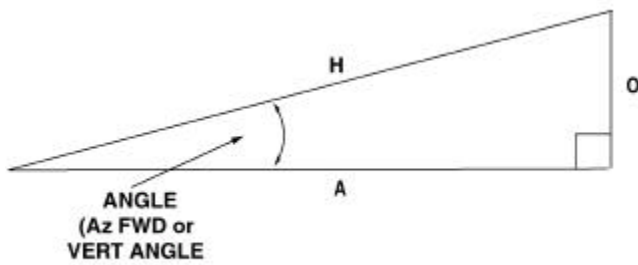

Figure 6-33. Right Triangle.

For computations of the coordinate and elevation triangles, it is easier to understand if we substitute the O, A, and H with the actual values used:

$$\sin (AzFwd \times 0.05625) = \frac{dE}{Grid\ Dist}$$

$$\cos (AzFwd \times 0.05625) = \frac{dN}{Grid\ Dist}$$

$$\tan (AzFwd \times 0.05625) = \frac{dH}{Grid\ Dist}$$

The formulas listed immediately above can also be written as—

$$dE = \sin (Az\ Fwd \times 0.05625) \times Grid\ Dist$$

$$dN = \cos (Az\ Fwd \times 0.05625) \times Grid\ Dist$$

$$dH = \tan (Vert\ Angle \times Grid\ Dist)$$

The previous example produced an azimuth forward (Carl to Andy) of 2520.254 mils. If the grid distance from Carl to Andy is 524.876 meters and the vertical angle is +27.821 mils, the dE, dN, and dH can be determined by substituting those values into the formulas immediately above.

$$dE = \sin (2520.254 \times 0.05625) \times 524.876$$

$$dE = 324.84\ \text{meters}$$

$$dN = \cos (2520.254 \times 0.05625) \times 524.876$$

$$dN = 412.28\ \text{meters}$$

$$dH = \tan (27.821 \times 0.05625) \times 524.876$$

$$dH = 14.34\ \text{meters}$$

The coordinates of Carl are E: 5 40666.21, N: 34

Determining the Coordinates and Elevation of the Forward Station

Determine the coordinates by algebraically adding the dE and dN to the coordinates of the occupied station. To algebraically add means to add or subtract depending on the sign (+ or -) of the subject value.

Determine the sign of the dE and dN by plotting the azimuth to the forward station. See figure 6-34.

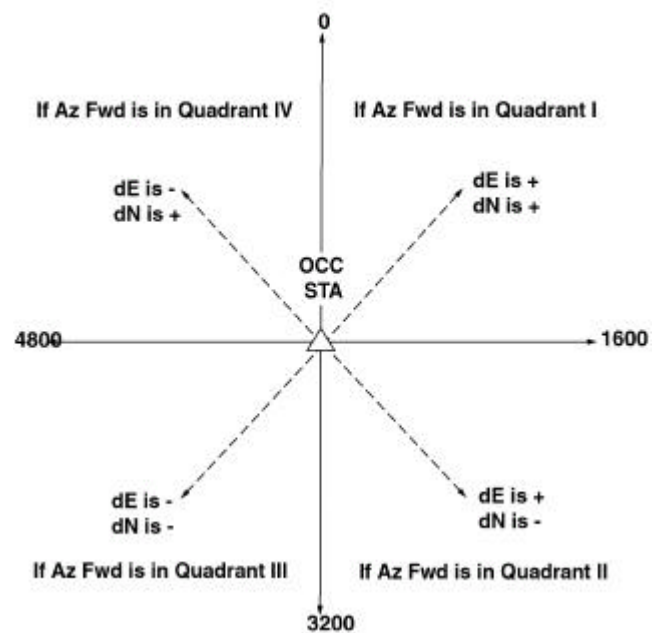

Figure 6-34. Determining the Sign of dE and dN.

The dE and dN with the proper sign are then algebraically added to the coordinates of the occupied station.

Determine the elevation by algebraically adding the dH to the elevation of the occupied station. The sign of the dH is the same as the sign of the vertical angle.

The examples shown produced an azimuth forward (Carl to Andy) of 2520.254 mils and produced a dE of 324.84 meters, a dN of 412.28 meters, and a dH of 14.34 meters.

13666.78, El (m): 666.34

The azimuth from Carl to Andy is 2520.254 mils which plots in quadrant II in figure 6-34. So, the dE is positive, the dN is negative. The coordinates of Andy are determined as—

Carl	5 40666.21	34 13666.78	666.34
dE, N, H	<u>+324.84</u>	<u>-412.28</u>	<u>+14.34</u>
Andy	5 40991.05	34 13254.50	680.68

Computing the Traverse

After computation of a main scheme leg, the station that was the forward station now becomes the occupied station. The data determined for that station determines the coordinates and elevation of the next forward station.

Figure 6-35 shows a traverse with only main scheme legs. It can be seen that the coordinates and elevation of Andy are used to compute the coordinates of John.

A traverse cannot continue from an offset station because the offset station is not occupied. Its coordinates and elevation are not used to compute another forward station. The next forward station is computed from the same station as the offset.

Figure 6-36 shows a traverse with an offset leg from Carl to Andy. The main scheme portion of the traverse runs from Carl to John, then to Jim. The coordinates and elevation of Andy will not be used to compute the

coordinates and elevation of John. The coordinates and elevation of John must be computed using the data from Carl.

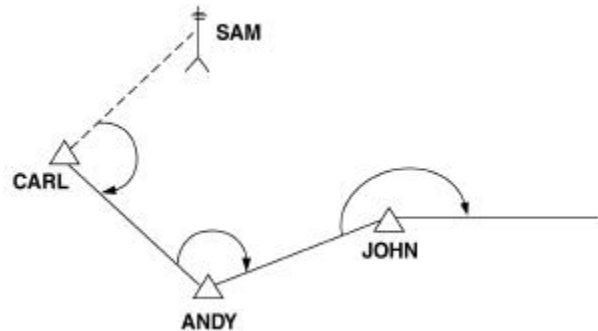

Figure 6-35. Main Scheme Legs.

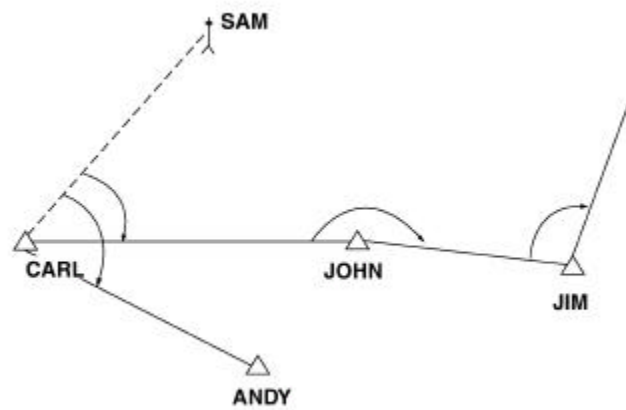

Figure 6-36. Offset Legs.

SECTION IV. CLOSURE

Traverse closure is performed by comparing the computed data for the closing station to the known data for the closing station. These comparisons produce errors that must meet certain specifications for the order of traverse being performed.

Three comparisons must be made to determine if a traverse meets closure specifications: coordinate comparison, elevation comparison, and an azimuth comparison. Closing data for a traverse consists of

radial error (RE) of closure, elevation error, azimuth error, and accuracy ratio. See figure 6-37.

Radial Error

A comparison between known and computed coordinates of the closing station is performed to produce an RE of closure. The RE is the distance from

the known coordinates to the computed coordinates. See figure 6-38.

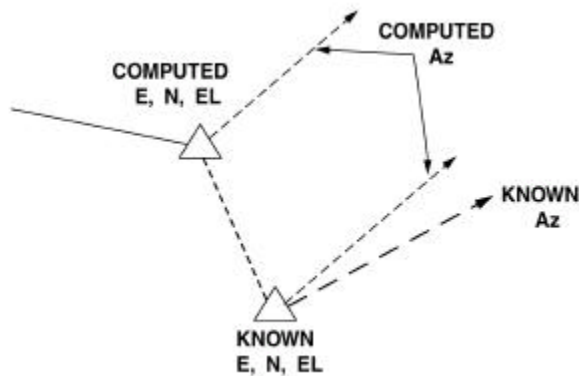

Figure 6-37. Traverse Closing Data Comparison.

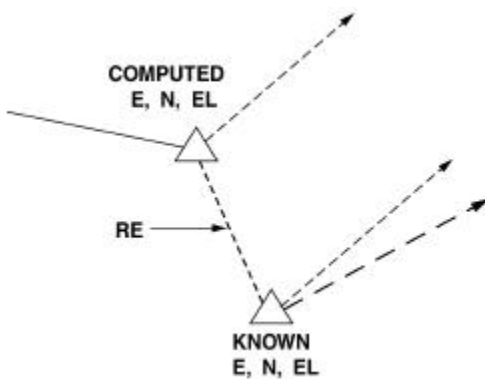

Figure 6-38. Radial Error of Closure.

Computing Radial Error

There are several ways to determine the RE. If the traverse was computed on a survey computer system, the RE is computed automatically. But it should be computed using the azimuth and distance programs in those systems or with the Pythagorean Theorem manually.

RE can be determined by performing the azimuth and distance computations available in survey computer programs. Data should be entered from the known coordinates to the computed coordinates. This is because the azimuth provided by these computations is the azimuth of the error that may be necessary to

determine the location of traverse errors should the survey not meet specifications.

The Pythagorean Theorem considers the RE as the hypotenuse of a right triangle and as sides of the triangle. See figure 6-39.

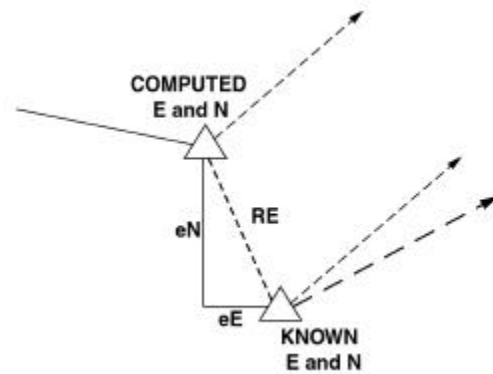

Figure 6-39. Pythagorean Theorem.

The Pythagorean Theorem states that in a right triangle, the square of the hypotenuse is equal to the sum of the squares of the sides. That formula can be expressed as—

$$C = \sqrt{A^2+B^2}$$

where C is the hypotenuse, and A and B are the sides of the triangle.

The eE, eN, and RE can be substituted into the formula as

$$RE = \sqrt{eE^2 + eN^2}$$

The eE is the difference between the known and computed easting. If the known easting value is a larger number than the computed easting value, the eE is negative. If the known easting value is a smaller number than the computed, the eE is positive.

The eN is the difference between the known and computed northing. If the known northing value is a larger number than the computed, the eN is negative; if the known northing value is a smaller number than the computed, the eN is positive.

The following example uses the Pythagorean Theorem to compute RE.

Determine eE and eN:

Known	E: 5 17265.98	N: 38 27648.32
Computed	E: 5 17265.54	N: 38 27649.02
Error (meters)	dE-0.44	dN+0.70

Determine RE:

$$RE = \sqrt{0.44^2 + 0.70^2} = 0.83 \text{ meters}$$

Allowable Radial Error

The allowable position closure (RE) for a traverse depends on the order of survey and the total traverse length (TTL).

If a fourth order traverse length is less than 9 kilometers, the allowable RE in closure is 1:3000 or 1 meter of RE for each 3,000 meters of traverse. Determine the allowable RE by dividing the total traverse length by 3,000. For example, if the traverse length of a fourth order survey is 3,469.910 meters, the allowable RE is 1.16 meters (3,469.910/3,000 = 1.1566).

If a fourth order traverse length is greater than 9 kilometers, the accuracy achieved may be better than 1:3000, yet the RE may be excessive. Determine the allowable RE by the following formula: square root of K whereas K equals the TTL in kilometers. If the TTL is 10,983.760 meters, then K equals 10.983760. In this example, allowable RE equals 3.314175613935 or 3.31 meters. If the TTL were divided by 3,000, the allowable RE would be 3.66 meters, 0.35 meters more than with the square root of K .

The allowable RE for a fifth order traverse is 1:1000 or 1 meter of RE for each 1,000 meters of traverse. Determine the allowable RE by dividing the total traverse length by 1,000. For example, if the traverse length of a fifth order survey is 2,986.321 meters, the allowable RE is 2.99 meters (2,986.321/1,000 = 2.986321). Allowable RE for a fifth order traverse equals K (TTL in kilometers).

Excessive Radial Error

If the RE of a traverse exceeds the specifications listed above for allowable RE, the traverse has “busted.” The traverse error location must be determined and corrected.

Elevation Error

A comparison between known and computed elevations of the closing station is performed to produce an elevation error (eH). The eH is the vertical distance from the known elevation to the computed elevation. See figure 6-40.

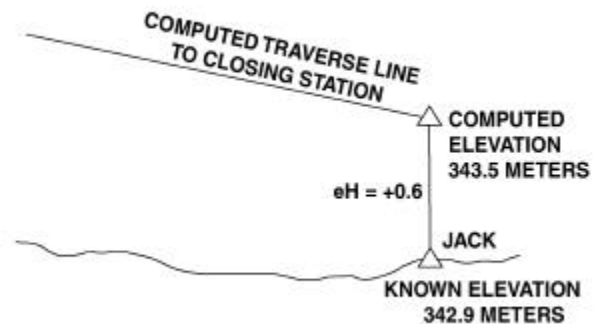

Figure 6-40. Elevation Error.

If the known elevation is a larger number than the computed, the eH is negative. If the known elevation is a smaller number than the computed, the eH is positive. Figure 6-40 shows station Jack with a known elevation of 342.9 meters and a computed elevation of 343.5 meters. The difference between the two values is 0.6 meters. Since the computed elevation is higher than the known, the sign is positive. The eH is written as +0.6 meters.

The eH is computed automatically by survey computer systems. Sometimes the value displayed by the program is the elevation correction. Elevation correction is the same value as eH with the opposite sign and is used for traverse adjustments.

The allowable eH for a traverse depends on the order of survey and the TTL. For fourth order, the allowable eH equals the \sqrt{K} when K is the TTL in kilometers. For example, if the total traverse length of a fourth

order survey equals 7643.765 meters, K is equal to 7.643765. Allowable eH in this example equals 2.764735972928 or 2.8 meters.

The allowable eH for a fifth order traverse whose TTL is less than 4,000 meters is ± 2 meters. As long as the computed elevation is within 2 meters of the known, the elevation closes.

The allowable eH for a fifth order traverse whose TTL is equal to or greater than 4,000 meters is determined from the formula—

$$1.2 \times \sqrt{K}$$

when K is the TTL in kilometers. For example, if the TTL is 6843.874 meters, K is equal to 6.843874. Allowable elevation error in this example is equal to 3.139 or 3.14 meters.

If the eH of a traverse exceeds the specifications listed above for allowable eH, the traverse has “busted.” Determine the eH location and correct.

Azimuth Error

A comparison between known and computed azimuths at the closing station is performed to produce an azimuth error (eAz). The azimuth error is the angular difference between the known azimuth and the computed azimuth from the closing station to the azimuth mark. See figure 6-41.

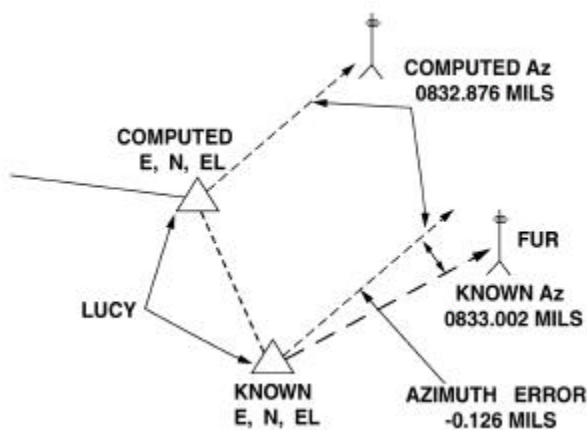

Figure 6-41. Azimuth Error.

If the known azimuth is a larger value than the computed, the eAz is negative. If the known azimuth is a smaller number than the computed, the eAz is positive. Figure 6-41 shows a known azimuth of 0833.002 mils and a computed azimuth of 0832.876 mils. The difference between the two values is 0.126 mils. Since the computed azimuth is lower than the known, the sign is negative. The eAz is written as -0.126 mils.

The eAz is computed automatically by survey computer programs. Sometimes the value displayed by the computer system is the azimuth correction. Azimuth correction is the same value as azimuth error with the opposite sign and is used for traverse adjustments.

The allowable eAz for a traverse depends on the order of survey and the number of main scheme angles, including the closing angle, in the traverse.

Fourth Order

The allowable eAz for a fourth order traverse with six or fewer main scheme angles is determined from the formula allowable eAz = $0.04 \text{ mils} \times N$; when N equals the number of main scheme angles, including the closing angle. For example, if a fourth order traverse contains 5 main scheme angles, the allowable eAz = $0.04 \text{ mils} \times 5 = 0.200$ mils.

The allowable eAz for a fourth order traverse with seven or more main scheme angles is determined from the formula $0.1 \times \sqrt{N}$ when N equals the number of main scheme angles, including the closing angle. For example, if a fourth order traverse contains 8 main scheme angles, the allowable eAz = 0.283 mils.

Fifth Order

The allowable eAz for a fifth order traverse is determined using the formula allowable eAz = $0.1 \text{ mils} \times N$; when N equals the number of main scheme angles, including the closing angle. For example, if a fifth order traverse contains 12 main scheme angles, the allowable eAz equals 1.2 mils.

If the eAz of a traverse exceeds the specifications listed above for allowable eAz, the traverse has “busted.” Location of the traverse error must be determined and corrected.

Accuracy Ratio

Certain minimum position accuracy requirements are prescribed for survey field work and computations. To determine whether this position requirement has been met for a closed traverse, an accuracy ratio (AR) is computed.

An AR is the ratio of position error to TTL. TTL is sum of the main scheme grid distances used to compute the traverse. AR is computed by dividing the TTL by the RE. For example, if the TTL of a traverse is 9843.785 meters and the RE is 2.01 meters, then $AR = 9843.785/2.01 = 4897.405472637$.

AR may be expressed as either a fraction with a numerator of one (i.e., 1/3000) or as a ratio (i.e., 1:3000). An AR ratio is read as one to the computed value; e.g., one to three thousand.

After the AR has been computed, the denominator of the fraction is always reduced to the next lower hundred; e.g., 1/4897 is recorded as 1/4800.

The minimum accepted value for an AR depends on the order of survey being performed. A traverse performed to fifth order specifications must produce an AR equal to or higher than 1/1000. A traverse performed to fourth order specifications must produce an AR ratio equal to or higher than 1/3000. However, if the TTL exceeds 9 kilometers, the RE must be within specifications.

If the computed accuracy ratio of a traverse does not meet the specifications listed above for minimum AR, the traverse has “busted.” The traverse error location must be determined and corrected.

Specifications

To verify that a traverse closes, compare computed errors to the following specifications:

REQUIREMENT	FOURTH ORDER	FIFTH ORDER
Adjusted	Yes	No
Position Closure If traverse length is— less than 9,000 meters more than 9,000 meters	1:3,000 \sqrt{K}	1:1,000 1:1,000
Height Closure If traverse length is— less than 4,000 meters more than 4,000 meters	\sqrt{K} \sqrt{K}	± 2 meters $1.2 * \sqrt{K}$
Azimuth Closure Six or fewer stations Seven or more stations Azimuth carried to Number of stations between azimuth checks	0.04 * N 0.1 * \sqrt{N} 0.001 mil 20	0.1 * N 0.1 * N 0.1 mil 25
Horizontal Angles Measured as Recorded to	One-position 0.001 mil	One-position 0.001 mil
Vertical Angles Measured as Recorded to Used in computations Reciprocals measured when	1 D/R 0.001 mil 0.001 mil Always	1 D/R 0.001 mil 0.001 mil Legs greater than 1,000 meters
Distance Measured electronically (slope distance)	Mean of 3 measurements after rejection limit of 0.01 from the mean	Mean of 3 measurements after rejection limit of 0.01 from the mean

SECTION V. ADJUSTMENT

An adjusted traverse is one where errors have been distributed systematically so that the computed closing station coincides with the known closing station. In artillery survey, only fourth order traverses are adjusted.

There is no way to determine the true magnitude of errors in the angle and distance measurements that occur throughout a traverse. A traverse adjustment is based on the assumption that errors have accumulated gradually and corrections are made accordingly. A traverse adjustment is also based on the assumption that all errors causing misclosure in the traverse are from field measurements (no errors are brought into the closure from previous adjustments or a lack of commonality).

Three adjustments must be made when adjusting a traverse: azimuth, coordinates, and elevation. These adjustments eliminate the effects of systematic (accumulative) errors assuming they have been constant in magnitude and direction over each traverse leg. Traverse adjustment cannot compensate for blunders such as improperly recorded data or misread angles.

A traverse that does not meet the closure specifications listed in section IV is not adjusted. It is checked and corrected using the traverse error location procedures in section VI.

Usually a traverse will close within specifications, but because some error sources cannot always be accounted for, closure will not be absolute. There will always be some measure of position, elevation, and azimuth error.

Most errors causing survey misclosure are cumulative. A cumulative error will generally be of the same magnitude, in the same direction, and occur in every measurement of that type; e.g., errors introduced by instruments that are not properly adjusted.

Random errors are those errors that cannot be accounted for. They vary in magnitude and direction and do not occur in all measurements; e.g., plumbing, leveling, and sighting errors.

Survey computer systems automatically adjust the main scheme portion of a traverse if so prompted.

Azimuth

Determining Azimuth Correction

The difference in easting and northing between two stations is determined by multiplying the grid distance by the sin and cos of the azimuth to the forward station. When adjusting a traverse, the azimuths used to compute those easting and northing differences are adjusted first. The total amount of azimuth adjustment is the azimuth correction. Determined by computing the eAz. The azimuth correction is the eAz with the proper sign affixed so that the computed azimuth with the azimuth correction applied equals the known azimuth. The azimuth correction is the same value as the eAz with the opposite sign.

Applying Azimuth Correction

The azimuth correction is distributed equally among the main scheme angles of the traverse with any remainder distributed to the larger angles. For example, assume a traverse has five main scheme angles, including the closing angle and the eAz for the traverse equals +0.966 mils. The azimuth correction equals -0.966 mils and is divided by the number of angles in the traverse. In this case, -0.966 mils/5 equals -0.193 mils per angle with a remainder of 0.001 mil. Each of the five angles will be adjusted by -0.193 mils and the largest angle will be adjusted by an additional 0.001 mil each to compensate for the remainder. See figure 6-42.

Occupied Station	Horizontal Angle	Azimuth Correction	Adjusted Angle
Carl	2520.254	-0.193	2520.061
Andy	1895.364	-0.193	1895.171
John	3725.468	-0.194	3725.274
Jim	1564.258	-0.193	1564.065
Jack	2635.842	-0.193	2635.649

Figure 6-42. Azimuth Adjustment.

Recomputing with Adjusted Angles

After the main scheme angles have been adjusted, the entire traverse is recomputed using the adjusted

angles. This produces new coordinates and closing data for the traverse with an azimuth error of zero mils. There will be no change in eH or TTL. It is now assumed that all eAz has been eliminated. Any remaining error is assumed to be a distance error.

Coordinate

Determining Total Coordinate Corrections

The total easting and northing corrections (tcE, tcN) for the traverse are determined by algebraically subtracting the coordinates of the closing station (after azimuth adjustment computations) from the known coordinates of the closing station. Use the following example to determine easting and northing corrections:

	<u>Easting</u>	<u>Northing</u>
Known	5 21874.98	34 87698.23
– Computed	<u>5 21874.71</u>	<u>34 87698.68</u>
Correction	(tcE) +0.27	(tcN) –0.45

Determining Station Corrections

The easting and northing corrections determined above are for the entire traverse. It is assumed that errors causing coordinate misclosure are accumulated proportionately throughout the traverse. The corrections must be distributed proportionately throughout the traverse. The amount of coordinate correction to be applied to each main scheme station (cE, cN) is determined by multiplying the total easting or northing correction (tcE, tcN) by the partial traverse length (PTL = sum of the traverse legs up to that station), then dividing by the TTL.

As an example, for a traverse with a TTL of 6734.973 meters and total coordinate corrections as determined above, the cE and cN for station Jack whose PTL is 3974.652 meters is determined as—

$$cE = +0.16 \text{ meters} \quad cN = -0.27 \text{ meters}$$

Determining Adjusted Coordinates

Adjusted coordinates for a main scheme station in a traverse are determined by algebraically adding the

easting and northing coordinate corrections (cE, cN) to the coordinates of the stations that were determined by the azimuth adjustment computations.

The following example shows how to determine adjusted coordinates using the coordinate corrections determined above:

	<u>Easting</u>	<u>Northing</u>
Jack (Az Adj)	5 24987.56	34 85673.87
Correction	<u>+0.16</u>	<u>–0.27</u>
Jack (Adjusted)	5 24987.72	34 85673.60

Offset Legs

There is no requirement to adjust offset legs. Even so, the computations performed for azimuth adjustment produced a new set of coordinates for the occupied station to determine the offset station coordinates. To ensure relativity, adjust offset legs by recomputing a single traverse leg using the adjusted coordinates of the occupied station and the adjusted azimuth from the occupied station to the rear station.

Elevation

Because elevation is the least important of the three elements of survey, it can be assumed that elevation closure error is accumulated in equal amounts at each traverse station.

Determining Elevation Correction

Compare the computed elevation of the closing station with the known elevation of the closing station and apply a sign (\pm) that causes the established height to equal the known height. The elevation correction is the same value as the elevation error with the opposite sign.

For example, if the known elevation for station Jack is 342.9 meters and the computed elevation is 343.5 meters, the elevation correction is -0.6 meters ($342.9 - 343.5 = -0.6$). For the elevation determined by traverse to equal the correct elevation, subtract 0.6 meters from the elevation of the computed closing station.

Determining Adjusted Elevation

The elevation correction is distributed equally among the stations of the traverse with any remainder distributed to those stations computed from the longest legs. Assume that the traverse for the elevation correction consists of five stations. To distribute the elevation correction throughout the traverse, divide the elevation correction by the total number of stations in the traverse excluding the starting station (a known height), in this case four, if the elevation correction is -0.6 meters. The elevation correction is determined from the formula $-0.6/4$ equals 0.1 with a remainder of $.2$ meters.

The adjustment is an accumulation of the correction since the correction applies to the differences in elevation between the stations and not directly applied to their elevations.

Discretion Adjustment

There will be times in the field when a surveyor will rely on judgment alone. Error/correction may be distributed arbitrarily in accordance with the surveyor's estimation of field conditions. It is reasonable to assume that heat waves will introduce larger errors over long lines than over short lines. Larger angular errors would be expected when lines of sight are steep and visibility is poor than when observing conditions are relatively favorable. Surveyors should not use this method of adjustment unless experienced and have a keen knowledge of where errors are most likely to occur and of their effect on the overall survey. In any event, the field notebook should contain a detailed account of any unfavorable survey conditions so that it may be used to substantiate any arbitrary adjustments.

SECTION VI. LOCATING TRAVERSE ERRORS

The artillery surveyor must isolate errors and determine their causes. Often, a critical analysis of the field work and the computations of a survey in error will result in timely delivery of the surveyed data to the firing unit.

Sources of Error

Many error sources exist that can cause a survey to bust. When trying to locate a traverse error it is assumed that only one error exists and that the error exists in the field work or computations. Trig lists from higher or adjacent echelon survey sections may sometimes contain errors. These errors are usually a misprint in the trig list and must be reported to the publishing agency as soon as possible.

Coordinate

When a trig list includes a misprint of a station's coordinates, it is usually a typographical error in either easting or northing, but not both. Sometimes the error

may be due to several sets of coordinates being established over the same point from different surveys or different survey agencies and the wrong set of coordinates being published. The SIC must determine the most accurate with respect to commonality.

A coordinate error will slide the entire traverse if closed on the same known station. The survey will appear to close but an unknown amount of position error will exist at each station.

A coordinate will appear as if a distance error is present in the survey if the traverse is closed on a second known point.

Elevation

When a trig list includes a misprint of a station's elevation, it is generally a typographical error. Sometimes, as with coordinates, more than one elevation may exist for the same station. The SIC must determine the most accurate with respect to commonality.

An elevation error will raise or lower an entire traverse if closed on the same station. The survey will appear to

close but an unknown amount of elevation error will exist at each station.

Elevation error will appear as if a vertical angle error exists in the traverse if the traverse is closed on a second known station. The survey will close for coordinates and azimuth but not for elevation.

Azimuth

When a trig list includes a misprint of an azimuth between two stations, it is usually a typographical error of a computed or astronomic azimuth. Sometimes the azimuth may have been computed correctly but the stations were not common or as with some coordinate errors, the wrong station coordinates were used when more than one set of values were available. Always perform your own computation of an azimuth when using a computed azimuth from a trig list.

An azimuth error will swing the traverse around the starting point if closed on the same station. The traverse will appear to close but it will contain an unknown amount of coordinate and azimuth errors.

An azimuth error list will appear as if an angle error exists in the traverse if the traverse is closed on a second station.

Field Work

Errors from field work will generally be of four types: distance, horizontal angle, vertical angle, and computational. The largest errors will be found in computations and recording. For the most part, field measurements made with the proper procedures will not include errors large enough to cause a survey to bust, especially with the precision available in current instrumentation. Most errors can generally be attributed to a lack of precise actions (attention to detail) on the part of the surveyors. Proper training, planning, organization, and field procedures will eliminate most errors. If field work and computations are done properly, the cause of position, azimuth, and elevation errors will be primarily due to the level of relativity of the survey control. In most cases, this will not bust a survey. The following are examples of errors caused by that lack of precise action.

All instrument readings must be clearly read to the recorder, then read back to the instrument operator. The IO must be viewing the scales when the values are read back, not turning to the next station or measuring the next distance. Improper instrument readings can result in distance, horizontal angle, and vertical angle errors.

Recording errors are generally found in the meaning of the recorded data. When possible and practical, the IO or team chief should verify those means before march ordering the equipment. The recorder must record the entire reading from the IO then read back what he has written, not what he heard. The recorder must listen for the command "bubble level", indicating the use of the automatic index by the IO, before recording vertical readings. Improper recording procedures can result in distance, horizontal angle, and vertical angle errors.

Computer errors are generally attributed to improper computation and check computation procedures. Computations and check computations must be performed independently.

Pointing errors can be located by measuring a direct and reverse reading over each station. Especially when a station is hard to pinpoint due to long distance or heat waves, a pointing error will result in horizontal or vertical angle errors that create a measure of azimuth and/or elevation error at closure. Very small distance errors are introduced in a survey that includes vertical angle errors and slope distances. This is because the vertical angle converts the slope distance to a horizontal distance.

Plumb and leveling errors can account for small amounts of distance and horizontal angle errors. If a target set and/or a theodolite is not properly plumb and level over their respective control points, the azimuth line being occupied is not the same azimuth line used in computations. This creates an azimuth/angle error.

Forward stations must be properly plumb and level. The forward station is the next occupied station. When the theodolite is set up over that station in the same tribrach as the target set, it must be already plumb and level, except for minor adjustments. If large plumb and level adjustments are made, the angle and distance

measurements from that station will be made from a different position than they were made to on the previous angle. This introduces small angle and distance errors.

Locating A Traverse Error

Procedures for locating an error in a traverse will isolate a suspect station (horizontal or vertical angle) or leg (distance). These procedures assume that only one error is present that is large enough to cause the excessive misclosure. They also assume the error is not in the control. Location of traverse error procedures may designate a suspected station or leg even when multiple errors are present.

Locating and correcting traverse errors can be performed in five steps:

- Step 1.** Close the traverse.
- Step 2.** Determine the eAz, RE, and eH.
- Step 3.** Determine the type of error indicated.
- Step 4.** Isolate the suspect station or leg.
- Step 5.** Check the field recorder’s notebook and computations for math errors. If no error is found, return to the field and remeasure the necessary segments of the traverse.

Traverse Error Indicators

Figure 6-43 shows the indicated traverse error based on the type of traverse and the status of the azimuth and coordinate misclosure.

		Close On Starting Station	Close On Second Station
Azimuth	Coordinates	Error Indication	
Good	Good	Good Traverse	Good Traverse
Good	Bust	Distance Error	Distance Error
Bust	Good	Opening or Closing Angle	Closing Angle
Bust	Bust	Angle Error	Opening or Station Angle

Figure 6-43. Error Indicators.

Azimuth Good, Coordinates Good

Obviously, if both azimuth and coordinates close, the traverse is good.

Azimuth Good, Coordinates Bust

Whether closing on the starting point or on a second point, if azimuth meets specifications but coordinates do not, the indicated error is a distance error. If an angle in the survey were bad, azimuth would bust also.

Azimuth Bust, Coordinates Good

When closing on the starting point, if azimuth busts and the coordinates are good, the error must be in the starting (opening) or closing angle. If an angle other than the opening or closing were in error or if a distance error were present, coordinates would not have closed.

When closing on a second known point, if azimuth busts and the coordinates are good, the error must be in the closing angle. An angular or distance error anywhere else in the traverse would create a coordinate misclosure.

Azimuth Bust, Coordinates Bust

When closing on the starting point, if azimuth and coordinates bust, the error must be an angle other than the opening or closing angle. A distance is not the indicated error. If it were, the azimuth would be good.

When closing on a second known point, if azimuth and coordinates bust, the error must be in the starting angle or a station angle, not the closing angle. The closing angle is not the indicated error, as the coordinates would have closed.

Elevation Busts

If coordinates close and azimuth close but height busts, see next paragraph.

Isolation of Distance Errors

A distance error is indicated when the azimuth for a traverse closes within tolerance but coordinate closure (RE) exceeds allowable specifications for that level of

accuracy. Two methods of isolating a distance error can be used: the parallel line method and the computation of azimuth of RE. Both methods work on the assumption that the azimuth of the RE is the same as the azimuth of the line with the distance error, whether the error is short or long.

Use the parallel line method to determine which line in a traverse contains a distance error. It identifies the indicated line by creating a line that lies along the same azimuth or parallel to the error.

Plot the traverse on a 1/25,000 grid sheet using the largest scale possible to make small errors easier to see. Label the stations, including known and computed closing stations. See figure 6-44.

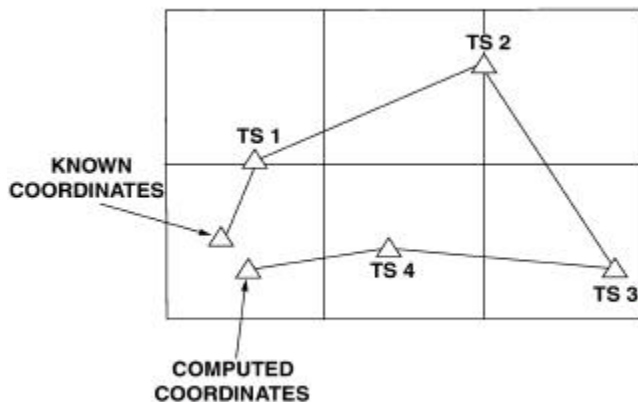

Figure 6-44. Plotting the Traverse.

Using a straight edge, trace a line between the known and computed closing stations. Allow this line to extend beyond the plotted points. See figure 6-45.

Identify the leg containing the error. The leg containing the error lies roughly parallel to the line traced above. Figure 6-45 shows the leg between TS-2 and TS-3 contains the distance error.

Another way to locate a distance error in a traverse is to compute the azimuth of the RE. Compute from the known closing coordinates to the computed closing coordinates with the handheld computer system (HCS).

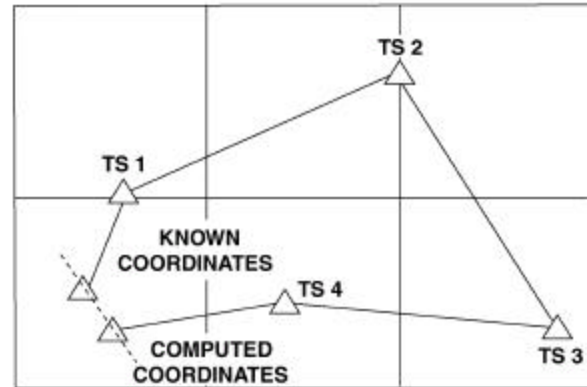

Figure 6-45. Determining the Error Leg - Parallel Line Method.

On the traverse form or the printout find an azimuth to rear that roughly matches the azimuth of the RE. The suspect leg is the leg with an azimuth or back azimuth closest to the computed azimuth.

In analyzing an error like this, some tolerance and judgment must be used to determine the traverse leg in error. In angular and distance measurements, minor errors occur that have a large affect on the overall accuracy but are small enough to make error analysis difficult. In some traverses, several legs with azimuths nearly parallel to the azimuth of the RE could be indicated as the leg with the error. Check the recorded data first, then the computations for each suspected leg. If there is no error in recorded data or computations, then each suspected leg must be remeasured until the leg containing the error is found.

Isolation of Angle Errors

An angle error is indicated when the azimuth does not meet allowable closure specifications for that level of survey. Sometimes an angle error, depending on its location, will result in coordinate error exceeding allowable RE. Two ways of isolating an angle error can be used: the perpendicular bisector method and the mil relation formula (WeRM rule).

Perpendicular Bisector Method

To determine which station in a traverse contains an angle error, use the perpendicular bisector by creating a line that passes over or near the station.

Step 1. Plot the traverse on a 1/25,000 grid sheet using the largest scale possible to make small errors easier to see. Label the stations, including the known and computed closing stations. See figure 6-46.

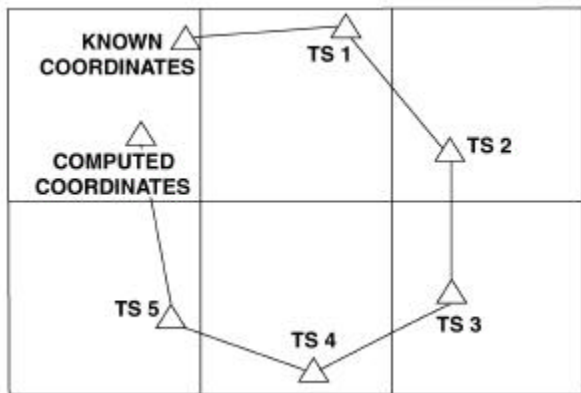

Figure 6-46. Plotting the Traverse.

Step 2. Using a straight edge, trace a line between the known and computed closing stations. Allow this line to extend beyond the plotted points. Place a dot on the line midway between the known and computed station. If the RE is large enough, divide it by 2 and measure the distance to ensure the dot is halfway between the points.

Step 3. Using a protractor, trace a line perpendicular to the RE line, extending into the survey.

Step 4. Identify the station containing the error. The line traced in step 3 will pass through or near the station with the angle error. The example in figure 6-47 indicates that station TS-3 contains the angle error.

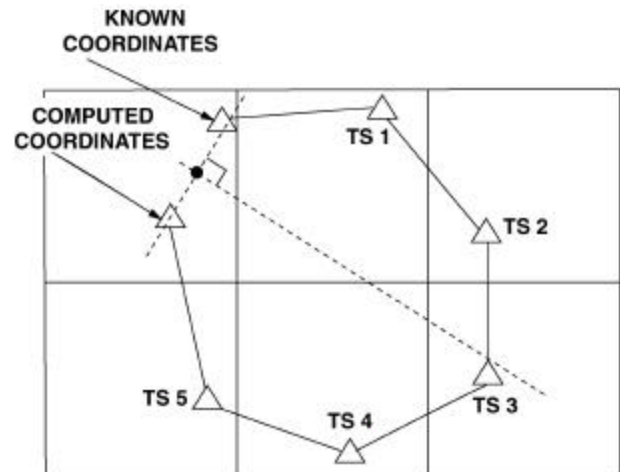

Figure 6-47. Determining the Error Station.

Mil Relation Formula (WeRM Rule)

Especially when closed on a second station or when the traverse follows a linear path, more than one suspect station could be identified by the perpendicular bisector method. The WeRM rule is a very good tool to isolate the error station.

The mil relation formula states that 1 mil of angle over a 1 kilometer distance will cause a 1-meter shift at the other end. See figure 6-48.

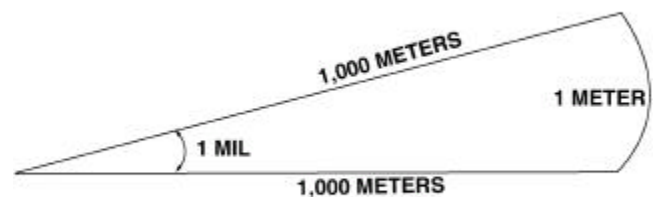

Figure 6-48. Mil Relation Formula.

The WeRM rule uses this relationship between angle and distance to determine a distance to a station containing an angle error that corresponds to the RE. The distance in kilometers to the station containing the angle error is computed by dividing the RE by the azimuth error. Determine—

$$R = W/m \text{ when—}$$

R is the range in kilometers

W is the radial error of closure

m is the azimuth error

Once the distance in kilometers is computed, locate a station that is that distance from the known station on the grid sheet used to plot the perpendicular bisector. The station in error should lie close to the distance.

Using a busted traverse that follows a linear path along a highway, the team chief has determined that an angle error exists. He isolates three possible stations that may contain the error using the perpendicular bisector method. The RE of closure is 66.32 meters, the azimuth error is 10.178 mils. Using the WeRM rule, the distance to the suspect station is determined as—

$$R = 66.32/10.178$$

$$R = 6.516 \text{ kilometers (6,516 meters)}$$

Analyzing Errors

In analyzing an error of this nature, some tolerance and judgment must be used to determine the traverse station in error. In angular and distance measurements, minor errors occur that have a large affect on the overall accuracy but are small enough to make error analysis difficult. In some traverses, several stations

could be indicated as the one containing the error. Check the recorded data first, then the computations for each suspected station. If there is no error in recorded data or computations, then each suspected angle must be remeasured until the station containing the error is found.

Isolation of Multiple Errors

Multiple errors are errors in azimuth and distance or more than one error in either azimuth or distance. When multiple errors in a traverse indications are the same as for an azimuth error. It is possible that using the procedure for azimuth error determination definite suspect stations will be located but an analysis will not reveal the error. The entire traverse should be performed again to locate the errors that were made.

Isolation of Elevation Errors

Vertical angle errors cause elevation errors. When a traverse does not meet allowable elevation error specifications, the suspect station can usually be isolated by comparing computed elevations and map spot elevations. At some point in the comparison, the elevation difference between computed and map spot elevations will change indicating a vertical angle error at the prior station. Check the recorded data and the computations at that station to locate the error. If the error cannot be located in the recorded data or the computations, return to the field and remeasure.

CHAPTER 7. ASTRONOMY

SECTION I. BASIC ASTRONOMY

The Tilted Polar Axis and Movement of the Earth

The Earth can best be visualized as an ellipsoid. The line connecting the flattened ends or the shorter axis is the Earth's rotating axis. The points on the Earth where this axis intersects the surface are the north and south poles; therefore, the rotating axis is also referred to as the polar axis. If the Earth's polar axis were perpendicular to its orbit around the Sun, there would be no change in seasons; the Sun's rays would always be directed at the Equator. Because the Earth's axis is tilted at an angle of approximately $23^{\circ} 30'$ (417.78 mils), the Sun's rays are directed at different portions of the Earth as it orbits the Sun. See figure 7-1.

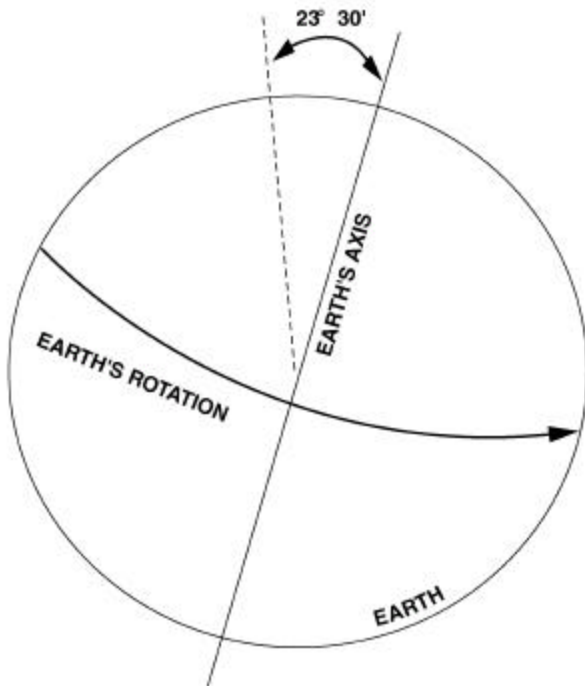

Figure 7-1. Earth's Rotational Axis.

The Earth and its motions are of primary interest to the artillery surveyor. These motions form a complex pattern, all of which affect the Earth's relationship to the stars and other planets.

The Earth's axis has a cone-shaped motion (or precession) making one turn in 25,800 solar years or one platonian year (great year). This is caused by torque imposed on the Earth mostly by the Moon and Sun. Visualize it as a spinning top. As the spinning slows, the top begins to wobble creating a cone-shaped motion in its rotating axis.

The Earth makes one 360° rotation on its axis every 23 hours 56 minutes 04.09 seconds. Rotation is from west to east. Because of revolution, the Earth must rotate more than 360° for the same point to face directly at the Sun on subsequent days.

The Earth revolves around the Sun approximately once every 365 days over a 600 million mile orbit at a rate of 18.5 miles per second. The counterclockwise orbit is elliptical with an average distance to the Sun of about 93 million miles. Other types of motion affect the Earth. The North and South poles are not stationary; they vary through rough circles approximately 40 feet in diameter. There is solar motion of 12 miles per second, while the Earth's portion of the galaxy is moving through space at approximately 170 miles per second.

Celestial Sphere

For purposes of practical astronomy, we assume that the Earth is at the center of the Universe and that everything else (the Sun, stars, planets, etc.) falls on the surface of a sphere of infinite radius referred to as the celestial sphere. We also assume that the Earth is stationary and that the celestial sphere rotates around the Earth from east to west. This is because the Earth

rotates west to east (counterclockwise), so the apparent motion of celestial bodies is the opposite direction. See figure 7-2.

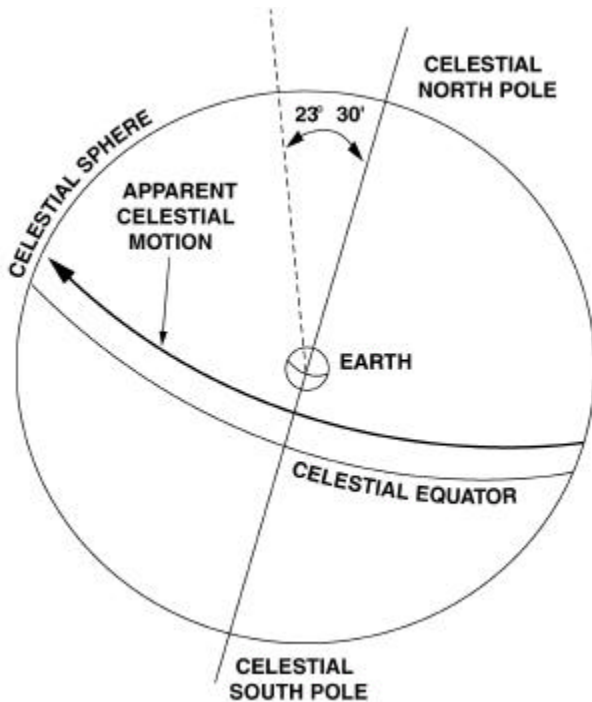

Figure 7-2. Celestial Sphere.

The celestial sphere rotates around the stationary Earth on an axis that coincides with the polar axis of the Earth. Locations of the celestial poles are at the point in the sphere where the Earth's polar axis would intersect the sphere if they were extended into space. If the plane of the Earth's Equator was extended into space, the point where that plane intersects the celestial sphere is the celestial Equator.

Celestial Coordinates

Computations of astronomic observations are performed in part using the celestial coordinates of points on the celestial sphere. Since these coordinates are located on the surface of a sphere, they are referred to as spherical coordinates. Generally, there are two systems of spherical coordinates: the horizon system and the Equator system. For artillery survey methods, the Equator system is used.

Any circle on the surface of the celestial sphere whose plane passes through the center of the celestial sphere is called a great circle. For example, the celestial Equator is a great circle. When that plane is set perpendicular to the celestial Equator it is referred to as an hour circle and includes both poles of the celestial sphere.

The observer's meridian is an hour circle that includes the plane of the observer's longitude. The upper transit of the observer's meridian is that part that includes the observer's longitude and the observer's zenith (the observer's plumb line extended upward to the celestial sphere). The lower transit of the observer's meridian is 180° from the upper transit and includes the observer's nadir (the observer's plumb line extended downward to the celestial sphere).

The position of the observer on the surface of the Earth is located by latitude and longitude. When the observer's plumb line is extended upward to the celestial sphere, a point referred to as the observer's zenith or the zenith position is established. The zenith position is also located by latitude and longitude and provides a fixed position of the observer's instrument on the celestial sphere. The zenith latitude is the arc distance from the celestial Equator to the observer's zenith. The zenith longitude is the arc distance along the celestial Equator from the plane of the prime meridian (Greenwich Meridian) to the plane of the observer's meridian extended to intersect the celestial sphere. Zenith longitude is also the angle between those two planes as measured at the celestial poles. See figure 7-3.

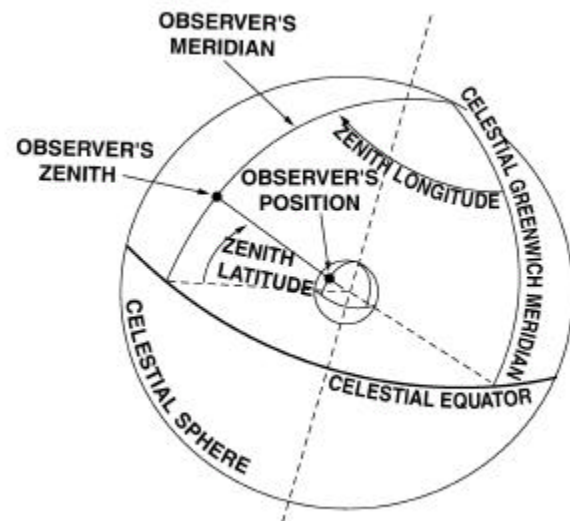

Figure 7-3. Zenith Position.

The prime vertical for the position of an observer is a great circle on the celestial sphere that is perpendicular to the observer's meridian at the zenith and intersects the observer's horizon at points due east and west of the observer.

The position of a star on the celestial sphere is defined in terms of right ascension (RA) and declination (dec).

As the Sun moves across the celestial sphere it traces a path referred to as the ecliptic. The ecliptic is tilted approximately $23^{\circ} 30'$ (417.78 mils) from the celestial Equator due to the tilt of the celestial sphere on its axis. It crosses the celestial Equator at two points along its path. The point where the ecliptic crosses the celestial Equator from the southern hemisphere to the Northern Hemisphere is the vernal equinox, the first day of spring usually around March 21. See figure 7-4.

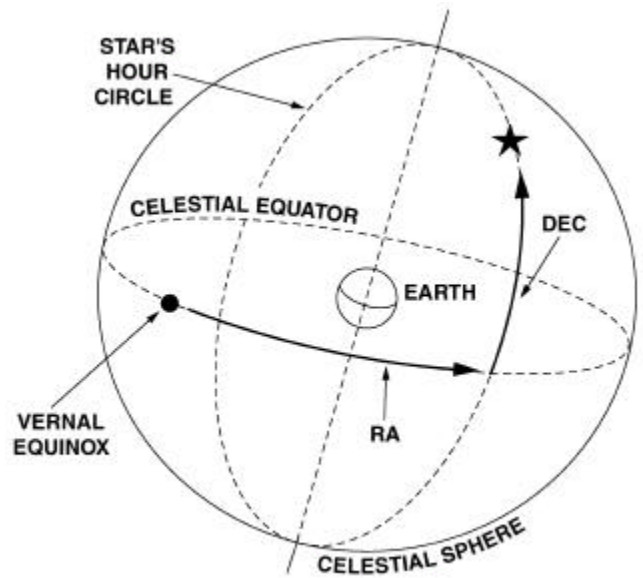

Figure 7-5. Right Ascension and Declination.

the hour circle of the star. It can be north (+) or south (-) of the celestial Equator and is usually expressed in terms of degrees ($^{\circ}$), minutes ($'$), and seconds ($''$). It can be expressed in terms of mils. Dec can vary from 0° to 90° north or south of the celestial Equator.

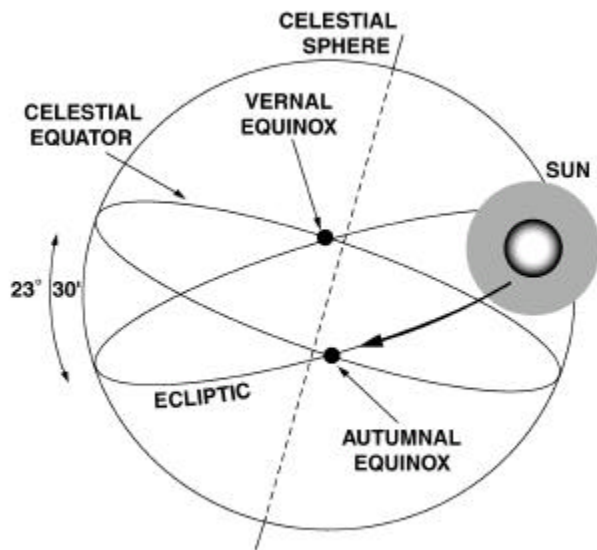

Figure 7-4. Ecliptic and Vernal Equinox.

See figure 7-5. RA is the arc distance eastward along the celestial Equator measured from the vernal equinox to the hour circle of a celestial body. In most cases, RA is expressed in terms of arc time; i.e., hours: h, minutes: m, and seconds: s. It can vary from 0h to 24h east of the vernal equinox. Dec is the arc distance measured from the celestial Equator to the body along

Astronomic Triangle (PZS Triangle)

Determining an astronomic azimuth requires on the solution of a spherical triangle located on the surface of the celestial sphere. This triangle is referred to as the PZS triangle. The PZS triangle has vertices at the celestial North Pole, at the observer's zenith, and at the star (or Sun). These vertices are the intersections of great circles that include the triangle's sides. See figure 7-6 on page 7-4. The method of astronomic observation determines the sides and vertices of the triangle to be solved.

The sides of the PZS triangle are segments of great circles passing through any two of the vertices. Sides are arcs and as such are measured with angular values. The three sides of the triangle are the polar distance, the coaltitude, and the colatitude.

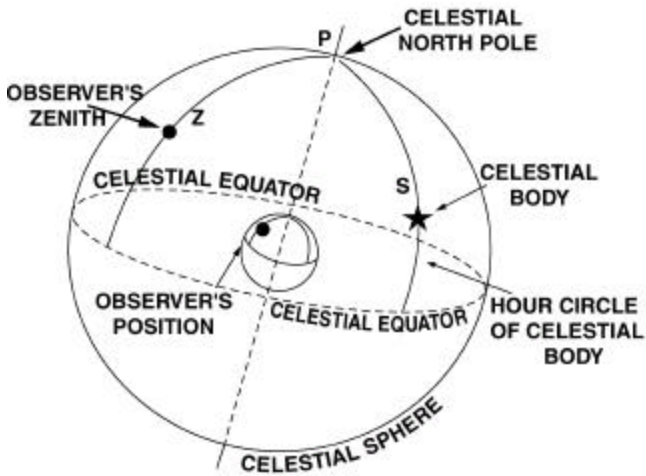

Figure 7-6. Vertices of the PZS Triangle.

Polar Distance

Polar distance is a segment of the hour circle of the celestial body. It is the arc length of the side of the PZS triangle from the celestial North Pole to the celestial body (the PS side). It is determined by applying the celestial body's declination to 90°. In other words, if the declination is north (+), the polar distance equals 90° minus the declination; if the declination is south (-), the polar distance equals 90° plus the declination. See figure 7-7.

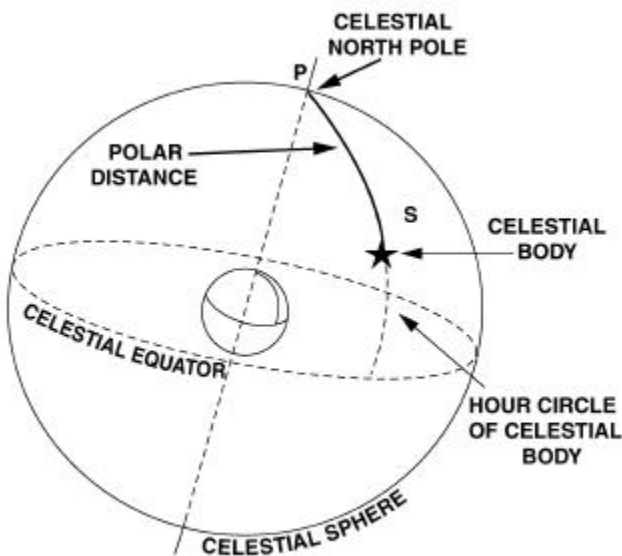

Figure 7-7. Polar Distance.

Coaltitude

Coaltitude is the arc length of the side of the PZS triangle from the celestial body to the observer's zenith. The observer's horizon is a plane that is tangent to the surface of the Earth at the observer's position. It is also perpendicular to the observer's zenith. See figure 7-8.

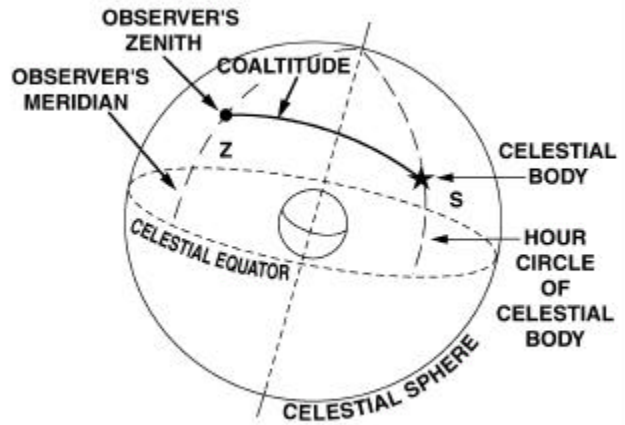

Figure 7-8. Coaltitude.

Determine coaltitude by subtracting the vertical angle (altitude) of the celestial body from 90° (1600 mils). This vertical angle must be corrected for refraction and parallax for sun observations and corrected for refraction for star observations. The resultant angle is side ZS of the PZS triangle and is referred to as the zenith angle of the celestial body. See figure 7-9.

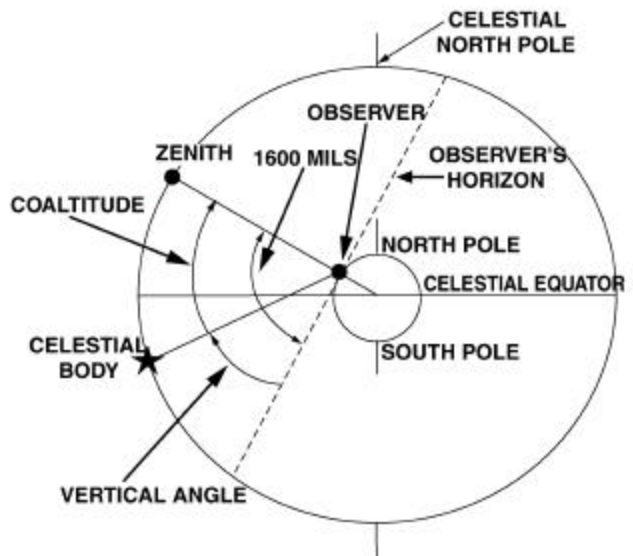

Figure 7-9. Determining Coaltitude.

Parallax can be defined as the apparent displacement of a body on the celestial sphere caused by a change in position of the observer. In other words, the observed altitude, or vertical angle, of a celestial body must be corrected for the error introduced by the observer's location on the *surface* of the Earth vice the *center* of the Earth. The nearest star is 26×10^{12} miles from Earth; the Sun is only 93×10^6 miles from Earth; because the stars are so distant, the apparent displacement of the stars is nearly immeasurable. For this reason, parallax corrections are used for observations on the Sun only. Parallax on the Sun varies from +9" when it is on the observer's horizon (vertical angle 0 mils) to 0" when it is on the observer's meridian. For artillery survey, a constant value of +7" (0.04 mils) is used. See figure 7-10.

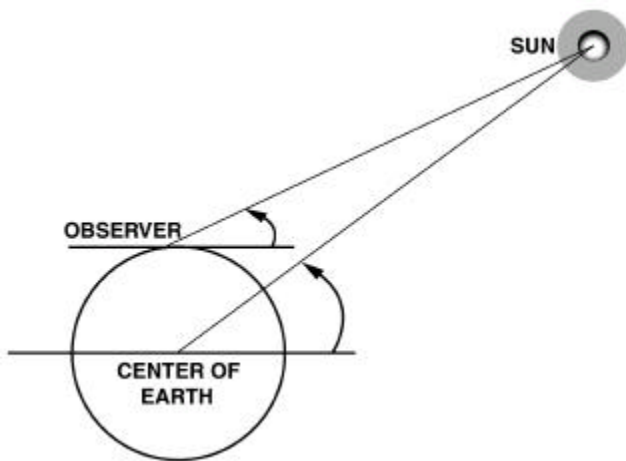

Figure 7-10. Parallax.

Refraction can be defined as the apparent displacement of a body on the celestial sphere caused by the deflection of light rays as those rays pass through the Earth's atmosphere. A ray of light passing through the Earth's atmosphere at a large angle of incidence, (the angle formed by the line of the light ray and a line which is perpendicular to the atmosphere), will have a larger refraction correction than a ray of light passing through an area close to the observer's zenith. Refraction of a body varies according to the altitude (vertical angle) of the body above the horizon and the temperature. For example, refraction of a celestial body located on the observer's horizon (0 mils) at a temperature of 70° is 10.26 mils; refraction of a body located on the observer's zenith is 0 mils. Refraction increases with an increase in barometric pressure and a decrease in temperature. Refraction corrections are always negative. See figure 7-11.

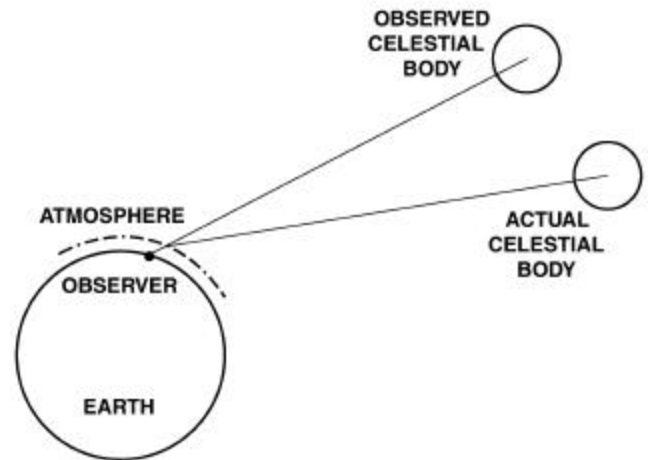

Figure 7-11. Refraction.

Colatitude

Colatitude is a segment of an hour circle known as the observer's meridian. It is the arc length of the side of the PZS triangle from the celestial North Pole to the observer's zenith (the PZ side). It is determined by applying the observer's latitude to 90°. If the observer's latitude is north (+), the colatitude equals 90° minus the observer's latitude. If the observer's latitude is south (-), the colatitude equals 90° plus the observer's latitude. See figure 7-12.

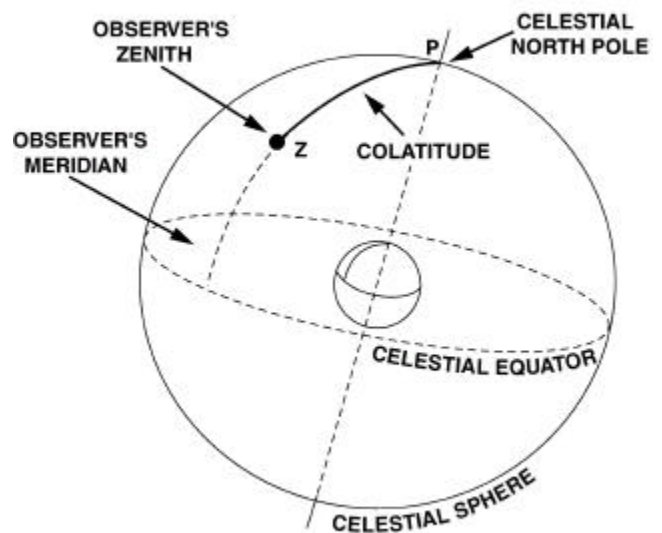

Figure 7-12. Colatitude.

Angles

The three angles formed by the intersection of the three sides of the PZS triangle are the parallactic angle, the hour angle (time angle), and the zenith angle.

The interior angle at the celestial body formed by the intersection of the polar distance side (PS side) and the coaltitude side (ZS side) is the parallactic angle. It is used in determining astronomic azimuths but is canceled out during the computations. See figure 7-13.

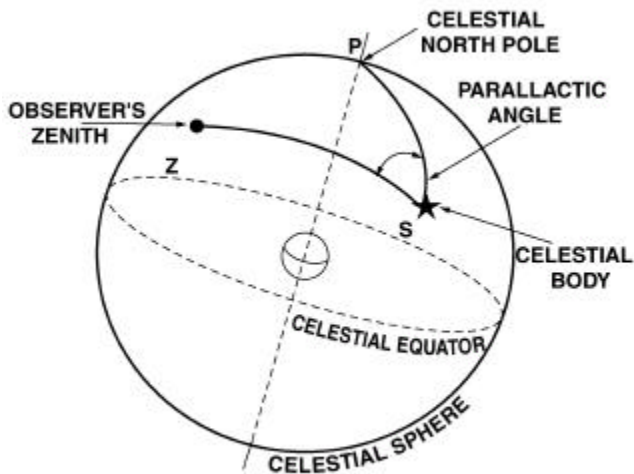

Figure 7-13. Parallactic Angle.

The interior angle at the celestial North Pole formed by the intersection of the polar distance side (PS side) and the colatitude side (PZ side) is the hour angle. The letter "t" designates the hour angle. The local hour angle represents the elapsed time since the celestial body crossed the observer's meridian. See figure 7-14.

The interior angle at the zenith formed by the intersection of the coaltitude side (ZS side) and the colatitude side (PZ side) is the azimuth angle or zenith angle. This angle is the product of computations and is the angle used to compute the true azimuth from the observer to the celestial body. When the celestial body is east of the observer's meridian, the true azimuth is equal to the azimuth angle. When the celestial body is west of the observer's meridian, the true azimuth is equal to 360° (6400 mils) minus the azimuth angle. See figure 7-15.

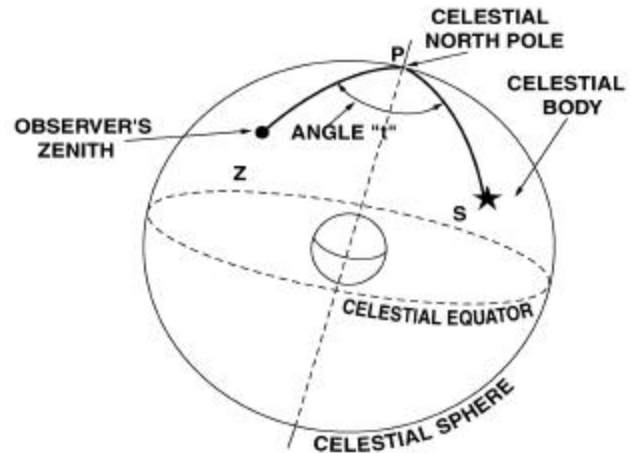

Figure 7-14. Hour Angle (Time Angle or Angle t).

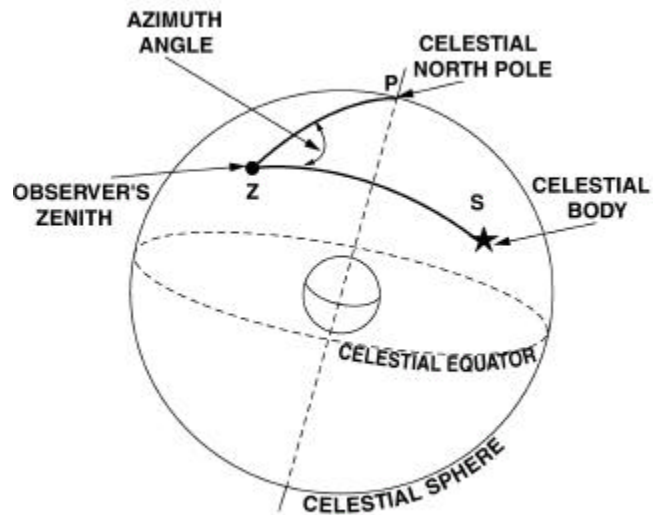

Figure 7-15. Azimuth Angle.

If any three elements of the PZS triangle are known, the other three elements of the PZS triangle can be determined by spherical trigonometry. In the end, the element that must be solved is the azimuth angle. This angle is necessary to establish a true azimuth on the ground. Figure 7-16 depicts the complete PZS triangle.

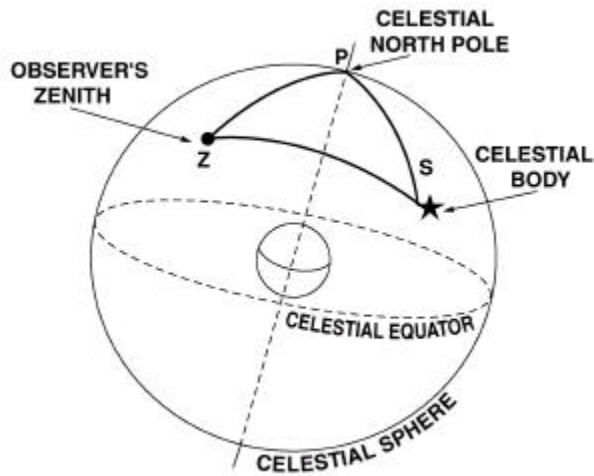

Figure 7-16. PZS Triangle.

The Relationship between Solar Time and Sidereal Time

Since the celestial bodies are in constant motion with the apparent rotation of the celestial sphere, the PZS triangle for each body is constantly changing. In order

to compute an astronomic azimuth, the precise moment of each observation must be fixed in time as to fix the position of the observer with respect to the position of the vertices of the PZS triangle. Because the rotation of the Earth is extremely constant, it is an excellent timekeeper. In the field of practical astronomy two classes of time are used; solar time and sidereal time.

Both classes of time are based on one rotation of the Earth with respect to a reference point. The reference point is the difference between the two time classes. Solar time is referenced to the Sun and a solar day is the amount of time necessary for two successive passes of the sun over a meridian of longitude. Sidereal time is referenced to the stars and a sidereal day is the amount of time necessary for two successive passes of the vernal equinox over a meridian of longitude.

See figure 7-17. Since there are approximately 365 days in a year, it can be said that the Earth moves nearly 1° of its 360° orbit around the Sun in 1 day. Note that the Earth must rotate nearly a full degree more for a successive pass of a meridian in a solar day than it has to in a sidereal day. This creates an apparent motion of the Sun among the stars of nearly 1° . In practical astronomy, with the Earth fixed and the celestial sphere rotating about the Earth, intervals

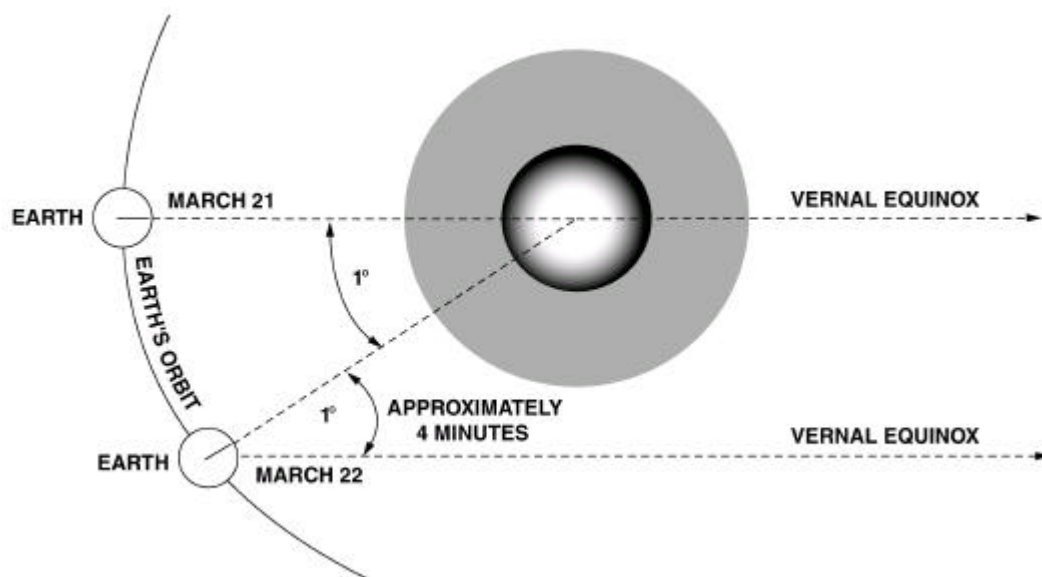

Figure 7-17. Relationship between Solar Time and Sidereal Time.

between transits of the Sun over the observer's meridian are nearly 4 minutes longer than transits of the vernal equinox over the observer's meridian. In other words, one 24-hour sidereal day equals 23 hours 56 minutes 04.091 seconds of a solar day.

One apparent rotation of the celestial sphere is completed in a sidereal day. A star rises at nearly the same sidereal time throughout the year. On solar time, it rises about 4 minutes earlier from night to night or 2 hours earlier each month. At the same hour, day-by-day, the star moves slowly westward across the sky as the year lengthens.

The solar day is considered the most natural unit of time for ordinary purposes. The solar day begins at solar midnight or the point when the Sun crosses the observer's lower transit. Solar noon is when the Sun crosses the observer's upper transit.

Apparent Solar Time

Time indicated by the position of the actual Sun is called apparent solar time. Apparent solar time for any point is the amount of time that has elapsed since the apparent Sun last crossed the meridian at that point.

Greenwich Apparent Time (GAT) is the amount of time that has elapsed since the apparent sun last crossed the lower transit of the Greenwich Meridian (180° long.). Local apparent time (LAT) is the amount of time that has elapsed since the apparent Sun last crossed the lower transit of the observer's meridian (solar midnight). Since the calendar day begins at solar midnight, the apparent solar time at any instant is equal to the hour angle of the Sun plus or minus 12 hours. See figure 7-18.

Apparent solar time is not usually considered accurate enough for most modern applications. For several reasons the length of an apparent solar day varies from season to season. Movement of the Sun is along the ecliptic and not the celestial sphere. The rate of this movement is not uniform. The Earth's orbit is elliptical and not circular. Thus, December 25 is 50 seconds longer than September 13 and days in January average 15 seconds longer than days in July.

Mean Solar Time

Because a more consistent measure of time is needed, a fictitious sun moving at a uniform rate along the celestial Equator was computed from the average

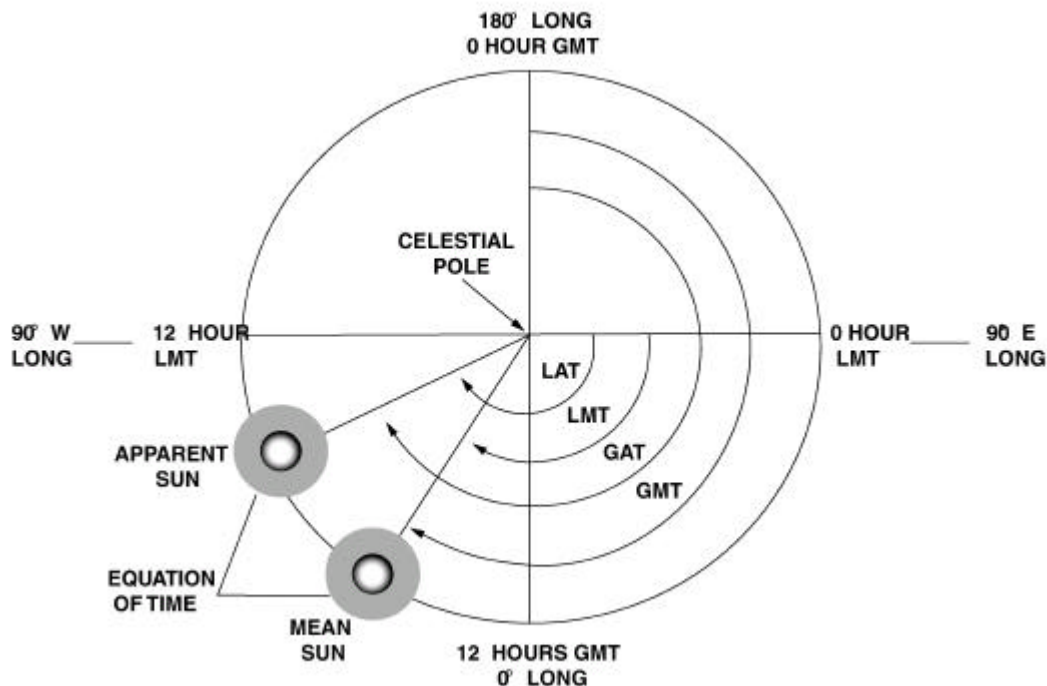

Figure 7-18. Concepts of Solar Time.

apparent solar time. Time measured by the position of the mean sun is referred to as mean solar time. Mean solar time is numbered from 0–24 uniform hours; each hour consists of 15° of arc or longitude ($360^\circ \times 24 \text{ hours} = 15^\circ$ per hour). Solar noon occurs when the mean sun crosses the observer's meridian.

Mean solar time for any point is the amount of time that has elapsed since the mean sun last crossed the meridian at that point. GMT is the amount of time that has elapsed since the mean sun last crossed the lower transit of the Greenwich Meridian (180° long.). Local mean time (LMT) is the amount of time that has elapsed since the mean sun last crossed the lower transit of the observer's meridian (solar midnight).

Equation of Time

The difference between apparent solar time and mean solar time is called the equation of time. This value can vary from +16 minutes (mean sun slow) to -14 minutes (mean sun fast), depending on the season.

Solar Year

A year can be defined as one complete revolution of the Earth around the Sun. A solar year is defined by 365.2422 mean solar days and can be referred to as a tropical year.

Concepts of Sidereal Time

The sidereal day begins when the vernal equinox crosses the observer's meridian at the upper transit (sidereal Noon). Sidereal time for any point is the amount of time that has elapsed since the vernal equinox last passed the meridian at that point. Local sidereal time (LST) is the amount of time that has elapsed since the vernal equinox last passed the observer's meridian; Greenwich Sidereal Time (GST) is the amount of time that has elapsed since the vernal equinox last passed the Greenwich meridian. See figure 7-19.

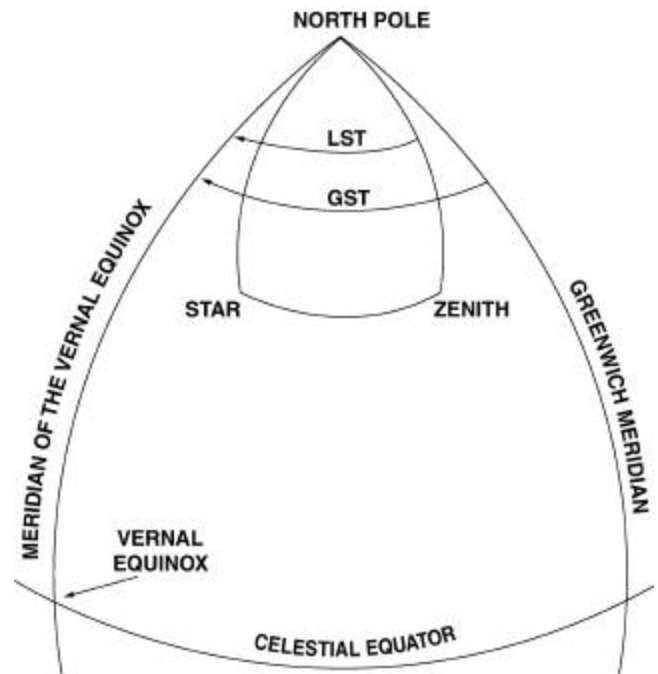

Figure 7-19. Concepts of Sidereal Time.

The annual apparent motion of the Sun along the ecliptic is opposite in direction to its daily path. Consequently, the relationship between solar time and sidereal time is variable. For example, on September 21 at the instant the vernal equinox crosses the observer's meridian, the mean sun is crossing the lower transit of the observer's meridian. At this instant, the sidereal clock of the observer will read 0h 0m 0s and a solar (civil) clock will read 0h 0m 0s. Twenty-four sidereal hours later, the vernal equinox will again cross the observer's meridian, but the mean sun will not yet have crossed the lower transit of the meridian. From this, we observe the solar clock reads 23h 56m 04.091s which shows the sidereal clock gains on the solar clock about 4m per sidereal day. This interval is accumulated throughout the tropical year so that while a solar year contains 365.2422 mean solar days, a sidereal year contains 366.2422 days.

Time Zones

The mean sun revolves around the Earth once every 24 mean solar hours (one mean solar day) and each hour the mean sun travels along an arc that is 15° wide. Each of these 15° arcs is referred to as a time zone.

The prime meridian is used as a basis of reference for time zones. Time at a point lying 15° west of the prime meridian is 1 hour earlier than at the prime meridian because the Sun has not yet crossed 15° W longitude. The opposite is true for a point lying 15° east of the prime meridian. Time is 1 hour later since the Sun has already crossed 15° E longitude. The difference in local time between two places equals the difference in longitude between the two places. See figure 7-20.

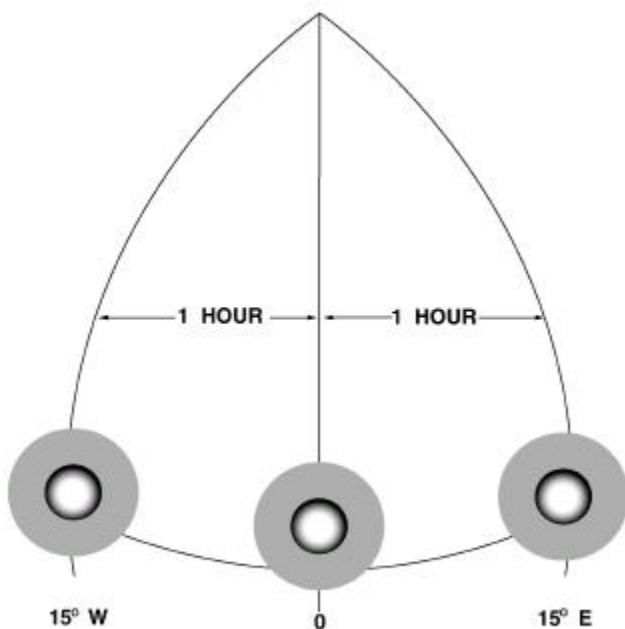

Figure 7-20. Time and Apparent Motion of the Sun.

Each 15° meridian east and west of the prime meridian is referred to as a standard meridian. Each zone extends 7.5° east and west of the standard meridian. The time zone including the prime meridian extends

from 7.5° E longitude to 7.5° W longitude; the time zone with a standard meridian at 90° W longitude extends from 97.5° W to 82.5° W. Four of these meridians (75° , 90° , 105° , and 120°) cross the United States. See figure 7-21.

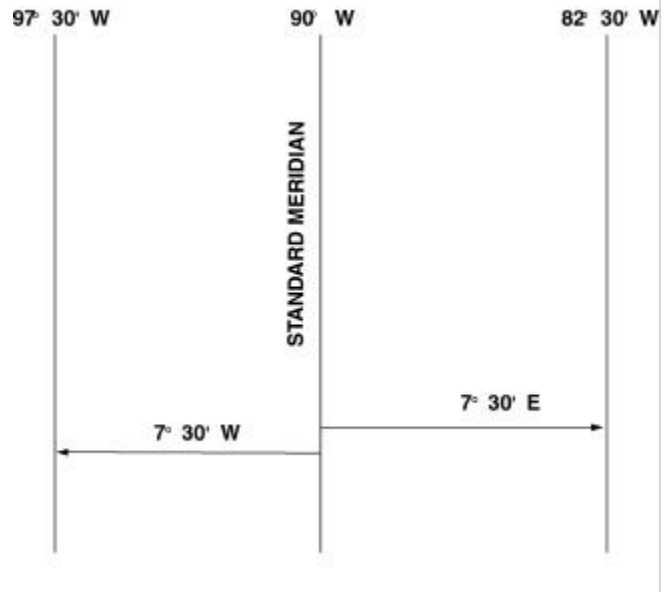

Figure 7-21. Time Zone Boundaries.

Standard time zone boundaries are often irregular, especially over land areas. Time zones generally follow the 7.5° boundary rule except when those boundaries are shifted to conform to geographical or political boundaries. For example, Ft. Sill, Oklahoma lies closer to the 105° W standard meridian, but for political boundary purposes, all of Oklahoma is located in the time zone using the 90° W standard meridian. Artillery surveyors use the term LMT in referring to standard time or local time in a referenced locale. The time used by the local inhabitants is local mean time unless a nonstandard time is in use. See figure 7-22.

Each of the 24 time zones is designated by a letter A-Z (J omitted). To preclude the problem of compiling and publishing time data for each of the 24 time zones, data was computed pertaining to one standard time zone. Standard time zone Z, which uses the Greenwich Meridian as a Standard Meridian, was chosen. Greenwich standard time (Zulu time), also known as



Figure 7-22. Political Time Zones in the U.S.

GMT or Universal Time, is defined as the length of time since the mean sun last crossed the 180th meridian (lower transit of the Greenwich Meridian) or solar midnight. This time can be expressed as the reading of the standard 24-hour clock at the Greenwich observatory at the moment an observation is made on a celestial body. Hence, it is the same time throughout the world. Since the observer's clock is usually set to standard (local) time, that time (LMT) must be converted to GMT. See figure 7-23 on page 7-12.

Daylight Saving Time

Daylight saving time is clock time advanced by 1 hour from standard time. Effective 1987, federal

law required that daylight saving time be observed from the first Sunday in April until the last Sunday in October. However, individual states may exempt themselves. During World War II, a double daylight saving time (2-hour advance) was observed nationwide and was called wartime.

Converting Local Mean Time to Greenwich Mean Time

LMT can easily be converted to GMT by applying a time zone correction.

Standard Meridian	Letter	Time Zone Correction	Standard Meridian	Letter	Time Zone Correction
0°	Z	0	0°	Z	0
15° E	A	-1	15° W	N	+1
30° E	B	-2	30° W	O	+2
45° E	C	-3	45° W	P	+3
60° E	D	-4	60° W	Q	+4
75° E	E	-5	75° W	R	+5
90° E	F	-6	90° W	S	+6
105° E	G	-7	105° W	T	+7
120° E	H	-8	120° W	U	+8
135° E	I	-9	135° W	V	+9
150° E	K	-10	150° W	W	+10
165° E	L	-11	165° W	X	+11
180° E	M	-12	180° W	Y	+12

**Figure 7-23. Time Zone Letter Designations and Corrections:
Local to Greenwich Mean Time.**

For the Western Hemisphere, divide the value of the standard meridian of the local time zone by 15°. The result is the time zone correction in hours. Add this correction to the LMT to determine GMT. If this result is greater than 24 hours, subtract 24 hours and add 1 day to obtain the Greenwich time and date.

For the Eastern Hemisphere, divide the value of the standard meridian of the local time zone by 15°. The result is the time zone correction in hours. Subtract this correction from the LMT to determine the GMT.

Converting Greenwich Apparent Time to Greenwich Mean Time

When the surveyor observes the Sun, he actually observes the apparent sun on the celestial sphere and not the mean sun on which his clock is based.

Consequently, the surveyor must convert his GAT to GMT. This correction is contained within the arty astro (hour angle) program and need not be determined manually.

Determining the Local Hour Angle and Angle t

When the position of the apparent sun at the time of observation has been determined and related to the Greenwich meridian, the time is referred to as GAT. By adding or subtracting 12 hours to or from the GAT, the surveyor determines the value of the Greenwich hour angle (GHA). GHA is the time that has elapsed since the Sun last crossed the Greenwich upper meridian (upper transit). To determine the local hour angle (LHA) in mils of arc, the GHA and the observer's longitude must be converted to mils of

arc. In the Western Hemisphere, determine the LHA by subtracting the observer's longitude (mils of arc) from the GHA in mils. In the Eastern Hemisphere, determine the LHA by adding the observer's longitude (mils of arc) to the GHA in mils.

Angle t is the angle in the PZS triangle at the polar vertex. If the LHA is greater than 3200 mils, angle t equals 6400 mils minus the LHA. If the local hour angle is less than 3200 mils, angle t equals the LHA.

SECTION II. ARTILLERY ASTRO METHOD

The primary astronomic method Marine artillery surveyors use is the artillery (arty) astro. Arty astro is based on the hour angle method and can be used with the Sun or stars. With the advent of the PLGR and SINCGARS, accurate time is now readily available to surveyors, making arty astro the preferred method. At the battery level the hasty astro method of observation will be used. See chapter 10.

See figure 7-24. Using two sides and the included angle solves the azimuth angle of the PZS triangle. The sides are the polar distance and the colatitude; the

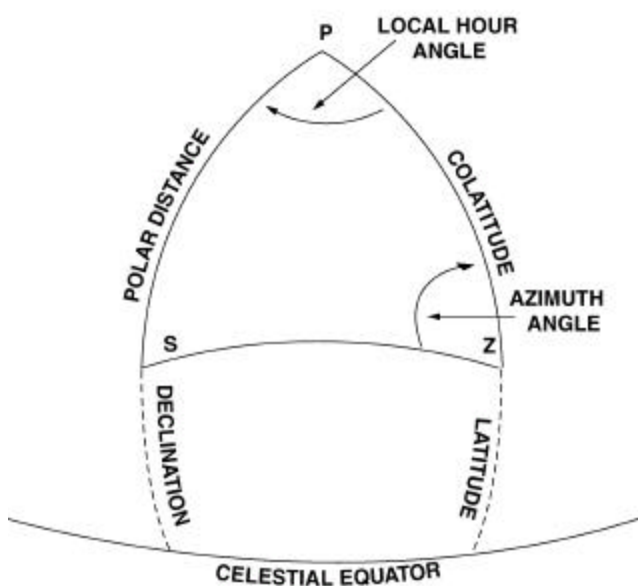

Figure 7-24. Solving the Arty Astro Method.

Appendices

Appendices A through C are critical tools for conducting astronomic observations. Appendix D gives conversions that may be required in unusual circumstances. Appendix E is a detailed glossary of acronyms, abbreviations, survey terms and definitions surveyors must understand. Appendix F lists references and related publications surveyors need to do their job.

angle is the local hour angle (angle t). In addition to the horizontal angle from an azimuth mark to the observed body, three elements must be determined:

- Latitude of the observer to determine the side colatitude.
- Declination of the observed body to determine the side polar distance.
- Accurate time of the observation to determine the LHA.

Arty Astro Method (Sun)

The arty astro method may be used to determine azimuths from Sun observations. The arty astro method does not require measuring a vertical angle or temperature and computations do not include a refraction or parallax correction. This method was once referred to as the hour angle method because the solution of the PZS triangle depends on solving the LHA.

Position of the Sun

For the Sun to be suitable for use with the arty astro method, it must not be within 1 hour of the observer's meridian. It must be between 175 mils and 1300 mils (preferably between 175 and 800) above the observer's meridian. An experienced IO may observe the Sun above 800 mils with an elbow telescope.

Time

In the arty astro method (Sun), time is critical to accurately determine local hour angle. Time must be accurate to 1 second. Accurate time is available through radio time signals and GPS receivers; i.e., PLGR, MSGR, and SINCGARS.

Solving the PZS Triangle

The formula for solving the PZS triangle has been arranged to require only determining the LHA. The two sides are stated in the formula in terms of declination of the Sun and latitude, thus eliminating the need for the computations of polar distance and colatitude.

For the hour angle solution, the element of the PZS triangle that is necessary is the LHA. Determine this angle by using the time of the observation. Generally, the LHA is determined by converting the local mean time (watch time) to Greenwich mean time (GMT), to Greenwich apparent time (GAT), to GHA, and finally to the LHA.

Local Mean Time

+time zone correction
=Greenwich mean time
 \pm equation of time for 0h
 \pm daily change for portion of day
=Greenwich apparent time
 \pm 12 hours
=Greenwich hour angle
 \pm longitude
=local hour angle

Greenwich Mean Time

The watch time of the observation is referred to as local mean time. This watch time is standard time for the area of operation. By applying a time zone correction the GMT (Zulu time) is obtained. This step can be skipped if the watch is set to Zulu time.

Greenwich Apparent Time

GAT is the time that has elapsed since the last passage of the apparent sun over the lower transit of the Greenwich meridian. GAT is obtained by applying the

equation of time and the proportionate part of the daily change in the equation of time to the GMT.

Greenwich Hour Angle

GHA is the amount of time that has elapsed since the sun last crossed the Greenwich meridian. Therefore, GAT is always ± 12 hours from the GHA. To determine the GHA, add or subtract 12 hours to or from the GAT. Remember: the result must be between 0 and 24 hours.

Local Hour Angle

The LHA of a celestial body is the time that has elapsed since that celestial body last crossed the observer's meridian. The formula to determine the LHA depends on the hemisphere (east or west) of the observer. In the Western Hemisphere, longitude and GHA are measured west from the Greenwich meridian. The LHA equals the GHA minus longitude ($LHA = GHA - Long$). In the Eastern Hemisphere, longitude is measured to the east; the GHA is still measured to the west. The LHA in the Eastern Hemisphere equals the sum of the GHA and the longitude minus 360° ($LHA = (GHA + Long) - 360^\circ$).

Several formulas can be derived for the solution of the spherical triangle when two sides and an included angle are known. The following formula was selected for use in artillery survey because of its simplicity:

$$\tan \frac{1}{2} (A + q) = \frac{\cos \frac{1}{2}(\text{Lat} - \text{Dec}) \cot \frac{1}{2}t}{\sin \frac{1}{2}(\text{Lat} + \text{Dec})}$$

$$\tan \frac{1}{2} (A - q) = \frac{\sin \frac{1}{2}(\text{Lat} - \text{Dec}) \cot \frac{1}{2}t}{\cos \frac{1}{2}(\text{Lat} + \text{Dec})}$$

Where: A is the astronomic azimuth (true) of the Sun measured east or west of the meridian.
 q is the parallactic angle (cancels out in computations).

Lat is the latitude of the station.

Dec is the apparent declination of the Sun.

t is the local hour angle (less than 12 hours) of the Sun.

Computations

Survey computer systems contain the arty astro program that easily computes an azimuth from the astronomic observations performed. The required ephemeris data and time calculations are completed within the program and do not require any manual computation.

Arty Astro Method (Star)

The arty astro method may be used to determine azimuths from observations on any of the 73 survey stars. Observations of the stars are generally considered to be preferred over those of the Sun due to more accurate sighting. The preferred star for this method in the Northern Hemisphere is Polaris. It displays the least apparent motion being a circumpolar star. In the Southern Hemisphere the preferred star is Alpha Acrux.

Position of the Stars

Polaris may be observed any time it is visible, but best results are obtained when it is 175 mils or higher above the observer's horizon. East-west stars can be selected by using the star ID program. The 175-mil restriction minimizes the effects of refraction.

Time

In the arty astro method (star), time is critical to the accurate determination of the local hour angle. Time must be accurate to 10 seconds for observations on Polaris and 1 second for observations on east-west stars.

Solving the PZS Triangle

The formula for solving the PZS triangle with star observations is the same as for the Sun. The only difference in the computations is sidereal time determines the LHA. See below:

Local mean time

+time zone correction
 =Greenwich mean time
 ±sidereal time for 0h GMT
 ±correction for GMT
 =Greenwich sidereal time
 –right ascension of the star
 =Greenwich hour angle
 ±longitude
 =local hour angle

Azimuth Specifications

The arty astro method can determine fourth or fifth order azimuth. For Marine artillery surveyors, a T2-E theodolite is used in each echelon of survey.

At least three sets of observations must be made on the celestial body. For fifth order, mean the three sets and reject any set that varies from the mean by more than 0.3 mils. For fourth order, mean the three sets and reject any set that varies from the mean by more than 0.15 mils. At least two sets must remain to determine the final azimuth for fourth and fifth order. The considered accuracy for a fifth order astronomic azimuth is ± 0.3 mils and ± 0.15 mils for a fourth order azimuth.

Selecting Methods of Observation

Surveyors must consider—

- Day or night, North or South latitude.
- Accuracy of the watch time.
- Positions of celestial bodies at specific times.
- Degree of accuracy required.
- Observer's position accuracy. This is more important for the computation of UTM grid convergence (true azimuth to grid azimuth) than for the actual observation computations.
- The experience of the instrument operator.

Observation and Tracking Procedures for Sun and Stars (Arty Astro)

While tracking procedures are virtually the same for the Sun and Star methods, observation is slightly different. Tracking a star is much more accurate than tracking the Sun due to the enormous distances involved. Stars appear as pinpoints of light even through the telescope, and offer a more defined target than the large fiery mass of the Sun.

Stars

When observing a star to determine astronomic azimuth the most difficult part is locating the desired celestial body. The instrument operator, with the telescope in the direct position, sights in on the azimuth mark to the desired direction. The initial circle setting is placed on the scales and recorded in the recorder's book. The instrument operator turns to the constellation containing the desired star and locates the star in the telescope. It is important to observe the movement of the star momentarily to determine its path in the telescope.

Once the stars' direction and rate of movement are determined, tracking begins. The instrument operator announces "tracking." The recorder keeps time while the instrument operator repeatedly announces "tracking" until he has the star centered in the cross hairs of the telescope. He announces "TIP" (meaning target in position). Immediately at TIP, the recorder notes and records the time of observation. The instrument operator reads the horizontal circle reading to the recorder who reads it back. Three direct readings are taken this way. Only after the third direct reading does the instrument operator plunge the scope and take three reverse readings using the same procedures, as required.

The Sun

When observing the Sun, the instrument operator, with the telescope in the direct position, sights in on the

azimuth mark to which direction is desired. The initial circle setting is placed on the scales, and recorded in the recorder's book. The instrument operator then places the sun filter on the telescope and turns to the Sun. The Sun must never be viewed through the telescope without a sun filter. Inspect the filter before use to ensure that the coated surface is free from any scratches or other defects. Serious eye damage will result if proper precautions are not taken. The Sun should also be observed momentarily to determine its path and rate of movement before tracking is announced.

The preferred position of the Sun in the telescope is centered in the solar circle as opposed to using the leading or trailing edge of the Sun. The instrument operator announces "tracking" repeatedly until the Sun appears in the center of the reticle. He then announces "TIP." The time is immediately noted and recorded in the recorder's book. The instrument operator reads the horizontal circle reading to the recorder who reads it back. Three direct readings are taken this way. Only after the third direct reading does the instrument operator plunge the scope and take three reverse readings using the same procedures, if required.

Direct and Reverse Readings

Reverse readings are required for fourth order azimuths only. Three direct readings may be taken consecutively, and as stated above, the telescope is plunged and the three reverse readings are taken.

SECTION III. STAR SELECTION—POLARIS

There are important advantages to using stars rather than the Sun as a source for astronomic azimuths. Stars appear as pinpoints of light in the telescope and are easier to track. At least one of the 73 survey stars can be found in a position that allows for astronomic observation, regardless of the observer's location or the time of night.

Polaris should *always* be used when it is visible. It is the most desirable star to observe because it is usually easy to locate and its slow apparent motion makes it easy to track. Because of weather

conditions, ambient light, line of sight barriers, or the observer's latitude, Polaris may not always be available. In this case, an east-west star must be used. East-west stars must be selected based on their position relative to the observer.

Orbit of Polaris

Polaris appears to move in a small, elliptical, counterclockwise orbit about the celestial North Pole.

The size of this apparent orbit varies slightly with the observer's latitude; at 35° N latitude, its minor diameter is about 45 mils. Because Polaris stays so close to the celestial North Pole, it is visible throughout the night in most of the Northern Hemisphere. When the Polaris LHA is 0 or 12 hours, the star is said to be in its upper or lower culmination, respectively. When the Polaris LHA is 6 or 18 hours, it is said to be in its western or eastern elongation. The small orbit of Polaris results in a very slow apparent motion, so the star may be observed at any point in its orbit. The least chance of error will occur when Polaris is in elongation. See figure 7-25.

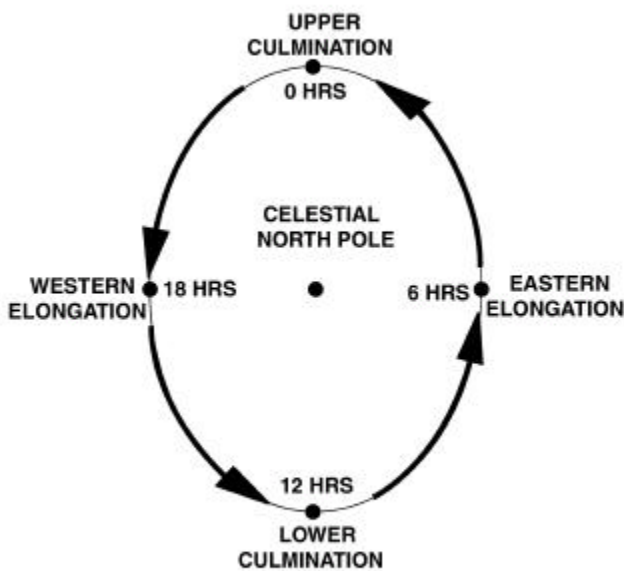

Figure 7-25. Orbit of Polaris.

Identifying Polaris

Polaris is the brightest star in the constellation Ursa Minor (Little Dipper), which is near the constellations Ursa Major (Big Dipper) and Cassiopeia (Lazy W). Polaris is the anchor (end) star of the handle of the Little Dipper.

Polaris can be identified by its relative position to Ursa Major. The two stars forming the side of the bowl farthest from the handle of the Big Dipper are called the pointer stars. An imaginary line extended through the pointer stars towards Cassiopeia nearly passes through the celestial North Pole. Polaris is approximately five times the distance between the pointer stars along the imaginary line from the Big Dipper. See figure 7-26.

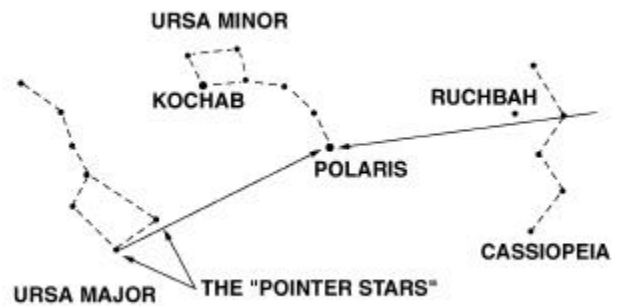

Figure 7-26. Identifying Polaris.

Polaris can also be identified by its relative position to Cassiopeia. Since Cassiopeia is on the same side of the celestial North Pole as Polaris, its position relative to the pole is approximately the same as Polaris'. Therefore, Cassiopeia can be used to determine whether Polaris is in elongation or culmination. A line drawn from the star Ruchbah, bisecting the shallow side of Cassiopeia, will pass closely by Polaris.

The vertical angle to the celestial North Pole equals the observer's latitude. Therefore, the vertical angle to Polaris is approximately equal to the observer's latitude. See figure 7-27 on page 7-18. Because the celestial sphere (and therefore the celestial North Pole) is an infinite distance from the Earth, the line to the celestial North Pole from the observer can be considered the same as the line of the rotational axis of the Earth (and celestial sphere). Angle A represents the observer's latitude; angle B the vertical angle to the celestial North Pole. The laws of geometry prove that since the observer's zenith is perpendicular to the observer's horizon and since the line to the celestial

north pole is perpendicular to the plane of the celestial Equator, angles A and B must be equal.

When the observer's latitude in mils is subtracted from 1600 mils, the result is the vertical reading to the celestial north pole, angle C in figure 7-27. When that vertical reading is set on the vertical scale of the theodolite in the direct mode, Polaris will appear in the field of view. If the star is at elongation, its vertical angle is equal to the observer's latitude. When Polaris is moving from eastern to western elongation, its vertical angle is greater than the observer's latitude; when Polaris is moving from western to eastern elongation, its vertical angle is less than the observer's latitude.

When a pointing is made on Polaris, the observer will see two other stars nearby which are not visible to the naked eye. However, when the reticle pattern in the telescope is illuminated, Polaris will be the only visible star.

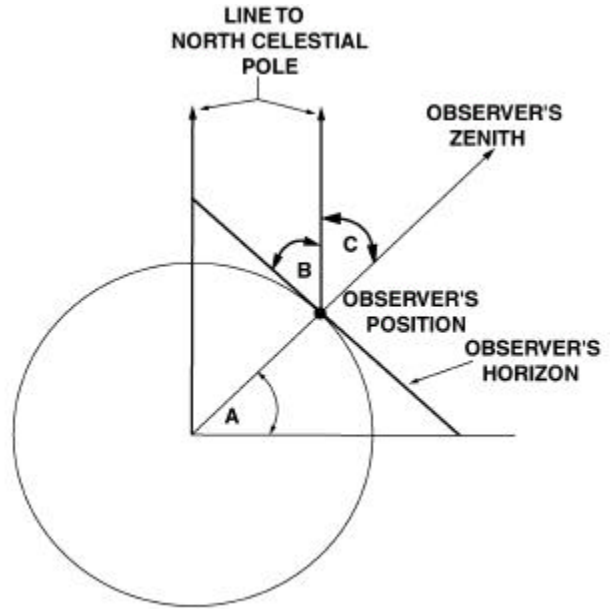

Figure 7-27. Relationship between the Observer's Latitude and the Vertical Angle to the Celestial North Pole.

SECTION IV. RECORDING ASTRONOMIC OBSERVATIONS

Arty Astro Method Field Notes (Fifth Order)

Heading and Column Titles

See figure 7-28.

Fill in the designation block with ARTY ASTRO (Sun) or (Star).

Fill in the date block with *the date the field work was performed*. This will be the date used in the computations.

DESIGNATION: ARTILLERY ASTRO (SUN) DATE: 4 DEC 2000					CHIEF OF PARTY: LCPL SMITH INSTR OPR: LCPL BAKER RCDR: LCPL ADAMS					
WEATHER: CLEAR, WARM INST: T-2E #123456					2					
STATION	T	h	TIME m	s	HORZ ↙	REMARKS				

Figure 7-28. Heading and Column Titles (Fifth Order Arty Astro).

Fill out the heading of the right side of the page the same as with traverse. Include the weather description, instrument number, COP name, IO name, and RCDR name.

Label column titles under the heading (from left to right) as follows:

1, STA. Identify the occupied, rear, and forward stations. The forward station star name will be listed.

2, T. Identify the telescope position (direct {D} or reverse ({R})).

3 and 4: TIME (h m s). This column designates the exact time the IO announced TIP during the observations. "TIME" is split between the columns in the top half of the blocks. Hours (h) are listed in the lower left corner of column 3, minutes (m) centered between the columns, and seconds (s) in the lower right corner of column 4.

5, HORZ. Record horizontal readings to the azimuth mark and to the celestial body.

7-12, REMARKS. Use this side of the page to record information pertinent to these observations. Include required entries and some optional information that may be needed by the computer or for future reference. See figure 7-29.

- Required entries are—
- Easting and northing of the occupied station.
- UTM grid zone.
- Horizontal datum/ellipsoid.
- Source of the position information.
- Center, leading or trailing edge if using the Sun.
- Time zone letter. If using local time, indicate daylight saving or standard times.
- Sketch (as close to scale as possible).

- Optional entries are—
- Location of occupied and rear stations.
- Route to these locations from a known point.
- Changes to data in trig list on the stations.
- Weather phenomena not covered in header information.
- RCDR, IO, COP initial blocks.
- Approximate azimuth to AzMk.

WEATHER: CLEAR, WARM		CHIEF OF PARTY: LCPL SMITH	
INST: T-2E #123456		INSTR OPR: LCPL BAKER 2	
		RCDR: LCPL ADAMS	
REMARKS			
OS is a wooden hub, 14 meters south of the centerline of the dirt trail south of GP 2. The EOL is 102 meters west of the OS.			
KNOWN DATA IS FROM PADS OPERATIONS DTD 29 JAN 2000:			
EASTING 554010.6			
WGS-84 NORTHING: 3834962.1			
GRID ZONE: 14			
All observations made to the center of the sun.			
!!!! ALL TIMES RECORDED ARE ZULU TIMES !!!!			
		RCDR I.O. COP	

Figure 7-29. Remarks for Arty Astro.

Recording Field Data

Record field data in the columns and rows corresponding to the pointing. Record the initial circle setting in the horizontal angle column in the rear station/direct reading row. See figure 7-30.

DESIGNATION ARTILLERY ASTRO					DATE: 4 DEC	
STATION	T	TIME			HORZ- α	
		h	m	s		
OCS WT	D				0000.191	
	R				3200.124	
ABLE 2						4282.014
SUN	D	20	50	48	5970.202	
	D	20	51	49	5974.008	
	D	20	52	39	5977.221	

Figure 7-30. Field Data (Fifth Order Arty Astro).

Fill out the “T” (telescope) column as shown in figure 7-30. The rear station (AzMk) name will be recorded in the direct (D) mode row directly below the STA column title. Skip one line to record the occupied station name. Skip one line to record the forward station (celestial body) name to the left of the first direct pointing on the body. If the celestial body is a star, record its name.

Record time (seconds, minutes, and then hours {24-hour format}).

To record angles, record the entire number then read the value back to the IO.

Record the closing angle and verify that the horizontal collimation error is within specifications (± 0.150 mils).

If the azimuth is being computed in the field using the computer’s internal clock, the solution is part of the field work. It must be included in the field notes. Record the solution in column 6 in the row listing the occupied station and circle it.

Arty Astro Method Field Notes (Fourth Order)

Two sets of observations are made: one with the telescope in the direct position, the second in the reverse. This method minimizes the effects of small pointing errors on the observed stations.

Heading and Column Titles

Titles will remain the same as fifth order recording except for the addition of column 6, MEAN.

See figure 7-31.

Fill in the designation block with ARTY ASTRO (Sun) or (Star).

Fill in the date block with the date the field work was performed. This will be the date used in the computations.

Fill out the heading of the right side of the page the same as with traverse. Include the weather description, instrument serial number, COP name, IO name, and RCDR name.

Label column titles under the heading from left to right as follows:

1, STA. Identify the occupied, rear, and forward stations. If the forward station is a star, list its name.

2, T. Identify the telescope position, direct (D) or reverse (R).

3 and 4, TIME (h m s). This column designates the exact time the instrument operator announced TIP during the observations. “TIME” is split between the columns in the top half of the blocks. Hours (h) are listed in the lower left corner of column 3, minutes (m) centered between the columns, and seconds (s) in the lower right corner of column 4.

DESIGNATION: ARTILLERY ASTRO (SUN)						DATE: 4 DEC 2000	CHIEF OF PARTY: LCPL SMITH			
							INSTR OPR: LCPL BAKER			
							RCDR: LCPL ADAMS			
							WEATHER: CLEAR, WARM			
							INST: T-2E #123456			
STATION	T	h	TIME m	s	HORZ ↺	MEAN	REMARKS			

Figure 7-31. Heading and Column Titles (Fourth Order Arty Astro).

5, HORZ. Record horizontal readings to the azimuth mark and to the celestial body.

6, MEAN. Record the solutions for the direct and reverse sets and the mean solution of the sets.

7-12, REMARKS. Use this side of the page to record information pertinent to the observations. Include required entries and some optional information that may be needed by the computer or for future reference as with fifth order observations.

Recording Field Data

Record the first set as the procedures listed for fifth order except that the solution is not circled. See figure 7-32.

DESIGNATION: ARTILLERY ASTRO (SUN)		DATE: 4 DEC 2000				
STATION	T	h	TIME m	s	HORZ \rightarrow	MEAN
OCS WT	D				0000.191	
	R				3200.124	
ABLE 2						
SUN	D	20	50	48	5970.202	
	D	20	51	49	5974.008	
	D	20	52	39	5977.221	
OCS WT	R				3200.124	
	D					
ABLE 2						
SUN	R					
	R					
	R					

Figure 7-32. Field Data (Fourth Order Arty Astro First Set).

Fill out the "T" (telescope) column as shown in figure 7-33. Allow three spaces between the last direct reading in the first set and the initial circle setting ("R" reverse reading) in the second set.

DESIGNATION: ARTILLERY ASTRO (SUN)		DATE: 4 DEC 2000				
STATION	T	h	TIME m	s	HORZ \rightarrow	MEAN
OCS WT	D				0000.191	
	R				3200.124	
ABLE 2						(4282.014)
SUN	D	20	50	48	5970.202	
	D	20	51	49	5974.008	
	D	20	52	39	5977.221	
						(4282.002)
OCS WT	R				3200.124	
	D				0000.196	
ABLE 2						(4281.990)
SUN	R	20	55	32	2787.911	
	R	20	56	16	2970.707	
	R	20	57	01	2793.403	

Figure 7-33. Field Data (Fourth Order Arty Astro).

When recording the second set, record the rear station (AzMk) name in the reverse (R) mode row. Skip one line to record the occupied station name. Skip one line to record the forward station (celestial body) name to the left of the first reverse pointing on the body. If the celestial body is a star, record its name.

When the field work is completed for the first set, the IO has a pointing on the rear station in the reverse position. This is the closing angle for the first set. The recorder will enter that closing angle as the initial circle setting for the second set. The IO needs only to observe the celestial body in the reverse position and close the angle in the direct mode to complete the second set.

Record seconds, minutes, and then hours (24-hour format).

When recording angles, record the entire number then read the value back to the instrument operator.

Record the closing angle and verify that the horizontal collimation error is within specifications (± 0.150 mils).

If the azimuth is being computed in the field using the computer's internal clock, the solution is part of the field work. Include it in the field notes. Record the solution in column 6 (MEAN) in the row listing the occupied station and place in parentheses. The azimuth determined from the

direct readings must equal the azimuth from the reverse readings, ± 0.150 mils. After the second set is computed, the solutions for the two sets are meaned. The mean azimuth is recorded in column 6 (MEAN) in the center row of the three spaces between the two sets.

CHAPTER 8. POSITION AND AZIMUTH DETERMINING SYSTEM OPERATIONS

Capabilities and Limitations

The Position and Azimuth Determining System (PADS) is a self-contained inertial surveying system that rapidly determines accurate position, elevation, and azimuth. It can be used with or apart from other assets available to the survey section, such as conventional assets and GPS receivers.

The PADS performs surveys faster than a conventional survey party. It provides coordinates, azimuth, and elevation to any point located where the vehicle can be placed or within 16 meters of the PADS. The PADS requires fewer personnel than a conventional survey party and less time for reconnaissance and planning. It provides data that meets accuracy requirements of most artillery systems and accurate azimuth when coordinates are assumed. The PADS—

- Limitations are mostly software-driven. The current PADS use a solid-state memory with Version 4 software.
- Has a continuous mission time if the system is updated at least every 7 hours or within a 55-kilometer radius, whichever comes first.
- Is limited to surveying between the latitudes of 75° N and 75° S.
- Is limited to operations between -150 meters to 4500 meters in elevation.
- Has ambient temperature operational limits of -50°F to 125°F.
- Requires the vehicle's electrical system to include at least a 100 amp alternator (200 amp preferable).
- Requires an initialization/alignment time of 30 to 45 minutes.
- Is limited to 12 programmed ellipsoids and 2 user defined options.
- Can only store 50 positions as update and mark stations.

Vehicles

The PADS can be mounted in any military vehicle as long as the correct lever arm information (plumb bob position) is known. The current PADS software (Version 4) is programmed with seven lever arms for six vehicles. It also stores up to three nondefined vehicles. Any vehicle used with the PADS must have an available 24-volt system. The following ground and air vehicles are programmed in the PADS with their corresponding lever arm.

The high mobility multipurpose wheeled vehicle (HMMWV) with the plumb bob mounted on the driver's door uses the PADS cue HUM for its lever arm.

The first lever arm for the M151 1/4 ton utility vehicle (Jeep) is located at the pintle hook with a PADS cue of M151. The second lever arm is the PADS plumb bob arm with a cue of PLMB.

The plumb bob is mounted on the commercial utility cargo vehicle's (CUCV's) pintle hook. The PADS cue is CUCV. The plumb bob for the small unit support vehicle (SUSV) is mounted on the driver's side mount. The PADS cue is SUSV.

When mounted on the UH-1 (Huey), the PADS plumb bob arm is used with a PADS cue of UH-1.

As with the Huey, the plumb bob arm for the OH-58 light observation helicopter is used. The PADS cue is OH-58.

The PADS can be transferred from a ground vehicle to a Blackhawk (UH-60) equipped with an AC to DC converter.

Accuracy: Zero-Velocity Corrections

Accuracy obtained from the PADS depends on how frequently Zero-Velocity Corrections (Z-Vels) are used during the survey mission. Z-Vels are performed

automatically by the PADS during all marks and updates. They must be performed by the operator at other times en route between stations. This operation allows the PADS to correct itself based on the large amount of data it has collected while moving from one position to another. A 10-minute Z-Vel is sufficient for most artillery survey operations. For some missions, a 5-minute Z-Vel is required; e.g., Q-37 radar sites and declination stations. Z-Vels are necessary for accurate computation of survey data. The PADS automatically performs Z-Vels during a 30-day bias, initialization, and all marks and updates. The operator must perform all Z-Vels during the mission between stations.

The PADS cues the operator 30 seconds before the scheduled Z-Vel by flashing the STOP and GO status indicators and by sounding alarm DS3. The driver stops the vehicle, places the transmission in neutral, sets the parking brake, and releases the foot brake. Once the vehicle stops, the operator presses the STOP key to start the Z-Vel. The PADS flashes GO when the Z-Vel is complete. Failure to perform the scheduled Z-Vel will degrade the accuracy of the survey data.

The operator changes the scheduled Z-Vel by performing the following keystrokes:

10 minutes: MON, ID, 4, 6, ENT, MON, 1, 0, 0, ENT.
5 minutes: MON, ID, 4, 6, ENT, MON, 5, 0, ENT.

The PADS defaults to the last Z-Vel time that was entered. Also see below.

10-Minute Z-Vel Accuracy

<u>Latitude</u>	<u>0°–65° N/S</u>	<u>65°–75° N/S</u>
Horizontal Position (CEP)	7.0 meters	10.0 meters
Vertical Position (PE)	3.0 meters	3.0 meters
Azimuth (PE)	0.4 mils	0.6 mils

5-Minute Z-Vel Accuracy

<u>Latitude</u>	<u>0°–65° N/S</u>	<u>65°–75° N/S</u>
Horizontal Position (CEP)	4.0 meters	7.0 meters
Vertical Position (PE)	2.0 meters	2.0 meters
Azimuth (PE)	0.4 mils	0.6 mils

Primary and Secondary Pallets

The PADS is contained in the primary and secondary pallets. When unpacked for the first time, the system will contain these pallets plus the mounting base (subfloor). The primary pallet is named for the metal-framed housing where the components are mounted. It has four major components.

Inertial Measurement Unit

The inertial measurement unit (IMU) contains three accelerometer sensors, two gyroscopes, and the associated electronics that maintain the survey coordinate frame and measure distances traveled to each coordinate axis. The accelerometers sense the movement and the gyroscopes give the accelerometers a reference point that detects actual movement. See figure 8-1.

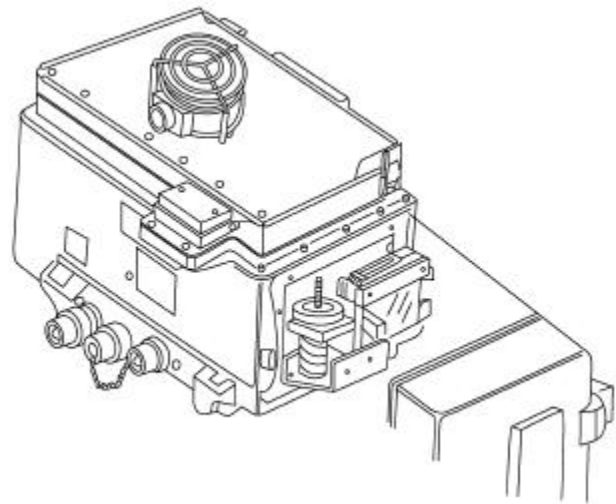

Figure 8-1. Inertial Measurement Unit.

A gyroscope is a spinning wheel that maintains a fixed orientation in space. It is also designed to act as a gyrocompass that finds true north by sensing the Earth's rotation. One gyroscope is oriented to true north while the other is aligned horizontal and perpendicular to the spin axis of the other gyroscope. This allows the PADS to provide a three-dimensional reference point to the accelerometers.

An accelerometer measures acceleration (the time *rate* of velocity). (If a car is going 50 miles per hour and

accelerates to 70 miles per hour, the actual acceleration time *rate* is 20 miles per hour.) The PADS uses three accelerometers. One measures north-south direction, one measures east-west direction, and one measures vertical direction.

Computer

The computer consists of a general-purpose digital computer and interface circuitry. It processes IMU data, computes survey data, and provides system control functions. The computer receives three signals from the accelerometers. These signals integrate with time to produce velocity signals. Velocity signals once again integrate with time to produce the distance traveled in each cardinal and vertical direction. Error signals are also produced for calculations for Earth rotation rates and keeping gyroscopes level during survey operations. See figure 8-2.

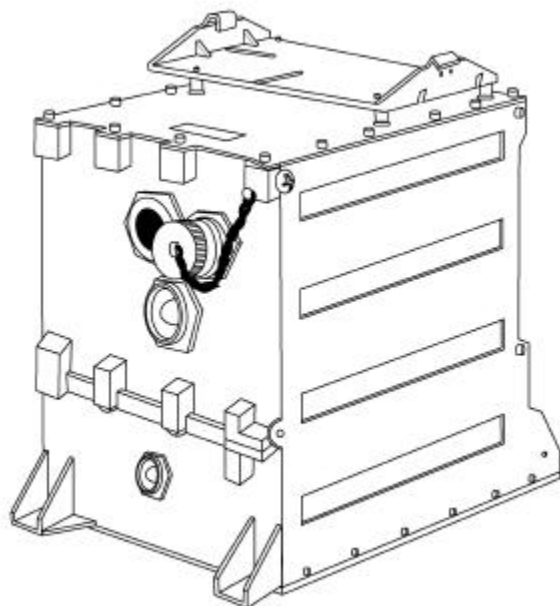

Figure 8-2. Computer.

Control and Display Unit

The control and display unit (CDU) is the operator's interface with the PADS. It is a keyboard and an alphanumeric display for operator entry and display of survey data and system commands. The CDU is the input/output device for the PADS computer. It is the

only portion of the PADS that must be accessible during a survey mission. See figure 8-3.

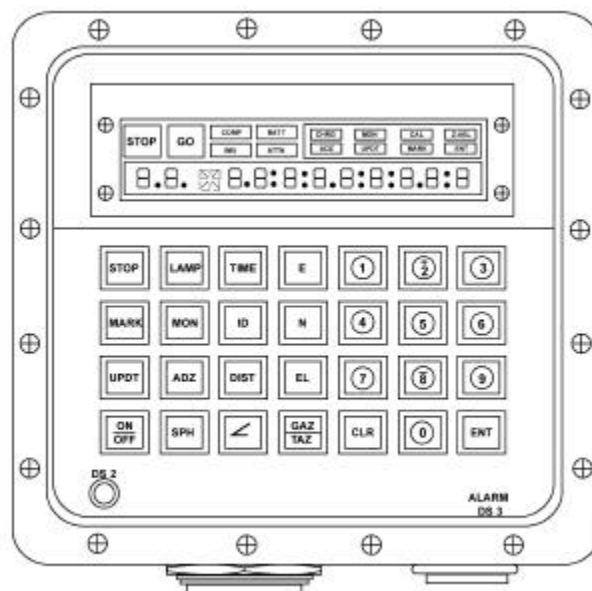

Figure 8-3. Control and Display Unit.

Power Supply

The power supply receives unregulated power from the vehicle or the PADS batteries and sends power out to the other PADS components. It supplies, controls, and regulates the amperage to the IMU, CDU, and computer, and charges the PADS auxiliary batteries. The computer also has a power supply. It receives the input power from the PADS power supply and regulates the amperage for the computer. See figure 8-4.

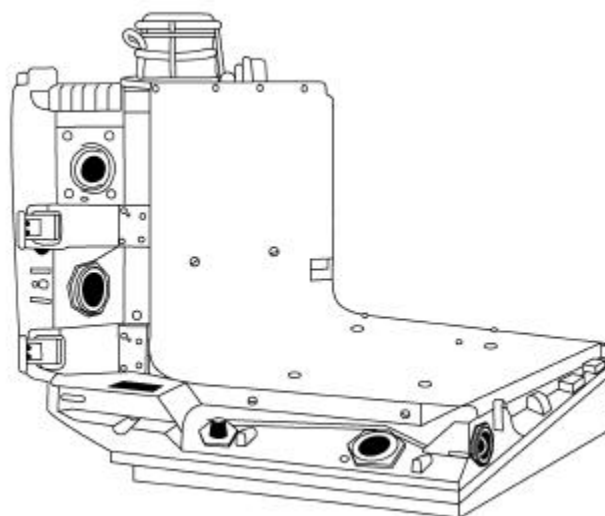

Figure 8-4. Power Supply.

The secondary pallet is the battery box. It contains two 12-volt DC batteries connected in series to provide 24 volts for back-up power. The battery box continues survey operations while the PADS is transferred between a ground vehicle and a helicopter. It provides additional power for initialization and back-up power if that vehicle power fails, and is a transport case that houses cables, tools, small hardware, spare lamps, modules, reference manuals, etc. See figure 8-5.

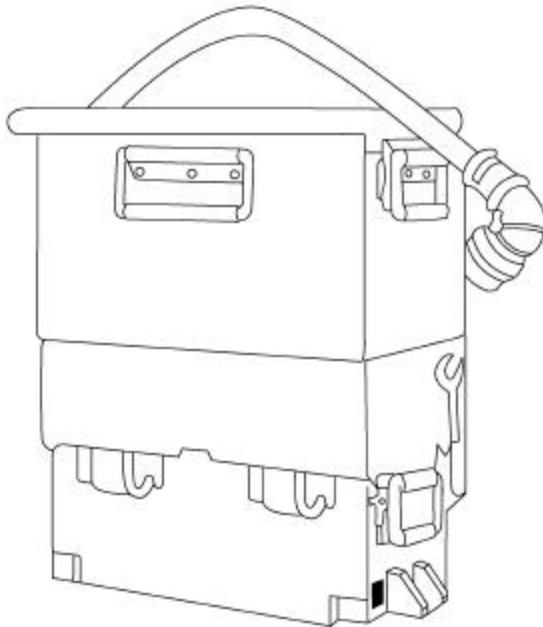

Figure 8-5. Secondary Pallet (Battery Box).

Control and Display Unit Operator Controls

Most of the operator controls are on the CDU. It has a keyboard and display for status/fault indicators. Status indicators usually appear as orange/yellow lights. The DS2 fault indicator shows white.

Status Indicators

The status indicators below with their functions are located on the top half of the CDU display. These lights prompt the operator to perform a task or indicate a possible malfunction. See figure 8-6.

COMP. Possible computer failure.

IMU. Possible IMU failure.

BATT. A steady BATT means the vehicle or PADS battery is not connected, the PADS battery is being discharged or one of the PS circuit breakers are off. A flashing BATT means the input voltage is too low and the PADS may turn itself off unless the problem is corrected.

ATTN. Operator error.

STOP. A flashing STOP tells the operator to stop for Z-Vel. A steady STOP tells the operator to remain stopped.

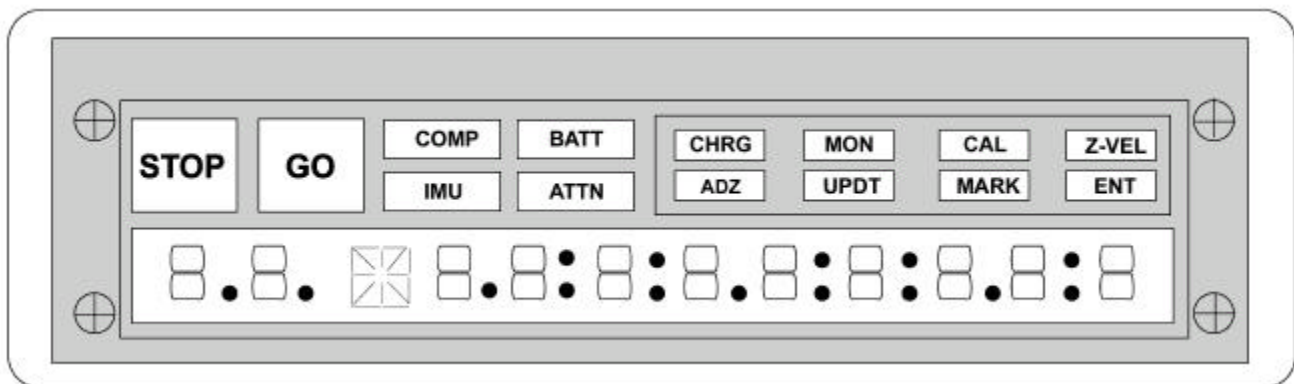

Figure 8-6. Status Indicators.

GO. A flashing GO tells the operator the vehicle can be moved. A steady GO means the vehicle has been moved since the last Z-Vel.

CHRG. Batteries are charging.

ADZ. Entry and display of position data are in the adjacent UTM grid zone.

MON. CDU displays user requested data in the monitor table.

UPDT. The system is ready to accept update data.

CAL. Lights during initialization and 30-day bias. Lighting during an update indicates the operator entered incorrect data or the system is out of calibration.

MARK. The system is recording marked survey data.

Z-VEL. PADS is performing Z-Vel.

ENT. Computer is ready to accept data from the keyboard.

Operator Commands

The CDU keyboard allows the operator to enter system commands and data.

STOP. Starts Z-Vel, lights STOP indicator, turns off audible alarm (IF ALARM IS ON), and illuminates the ATTN status indicator if pressed while vehicle is moving.

MARK. Initiates position mark procedures. Lights MARK indicator. Pressing MARK twice cancels a position-mark procedure.

UPDT. Initiates position and/or elevation update procedure. Lights UPDT indicator. Pressing UPDT twice cancels an update procedure.

ON/OFF. If the system is off, pressing ON/OFF applies power. If the system is on, pressing ON/OFF causes the CDU to display commands for shutdown procedures.

LAMP. Tests all CDU status indicators, alphanumeric display lamps, and system fault indicators. When held down varies lamp intensity and sounds DS3 ALARM.

MON. Selects the monitor mode. Lights MON status indicator.

ADZ. Directs the system to enter or display the adjacent UTM grid zone. Lights the ADZ indicator.

SPH. Allows the entry and display of spheroid (ellipsoid) options. Allows the option for performing a 30-day bias or for entering geographic coordinates.

TIME. During 30-day bias, initialization and Z-Vel, displays elapsed time since turned on. When the vehicle is moving, it displays time to the next Z-Vel. Silences ALARM DS3 for 30 seconds.

ID. When pressed, followed by an ID number, followed by ENT, cues PADS to provide mark data for the ID number entered. ID, 0, ENT indicates current data display. Pressing ID twice selects PAE display.

DIST. Allows entry and display of the distance between the porro prism and a theodolite for an optical position mark. Displays the distance between points on a two-position azimuth mark.

<. > Allows entry and display of a horizontal angle measured by a theodolite.

E. Allows entry and display of the UTM grid zone and easting.

N. Allows entry and display of a northing coordinate; when pressed twice, indicates Southern Hemisphere by displaying "S". Only during the initial entry of data may the change in selection of hemisphere from northern to southern be made.

EL. Allows entry and display of elevation.

GAZ/TAZ. Displays grid azimuth. When pressed twice, displays true azimuth, clear or enter (TA C-E). Operator may display true azimuth by pressing ENT. If CLR is pressed, grid azimuth is displayed.

1,2,3,4,5,6,7,8,9,0. Enters numerical data as selected.

When elevation has been selected for entry of data, the first pressing of the 2 or 8 will enter a + or -, respectively. Thereafter, the 2 and 8 revert to normal number functions. Advances (+) and decreases (-) through ID and monitor numbers.

ENT. Causes displayed data or function to be entered into the computer or executed.

CLR. Clears display and mode selection.

DS Alerts

The CDU has two DS alerts that indicate a specific task needs to be performed or that a malfunction has occurred. ALARM DS3 warns the operator to stop for a Z-Vel or may sound if there is excessive motion during initialization. Fault indicator DS2 indicates the CDU is functioning (black) or malfunctioning (white).

Power Supply Operator Controls

CB1 controls battery power from the PADS battery box to the power supply. CB2 controls vehicle power from the prime mover to the power supply.

The BATT FAIL fault indicator DS1 turns from black to white when the PADS batteries lack sufficient power to maintain standalone system operations. The PS FAIL fault indicator DS2 indicates if the power supply is functioning (black) or malfunctioning (white).

The M1 (elapsed time indicator) displays the total power supply operating time.

Computer Operator Controls

The M1 (elapsed time indicator) displays the total computer operating time. The fault indicator DS1 indicates whether the computer is functioning (black) or malfunctioning (white).

IMU Operator Controls

The elapsed time indicator displays the total IMU operating time.

The porro prism controls align the theodolite to the IMU during optical measurements (offset). See figure 8-7.

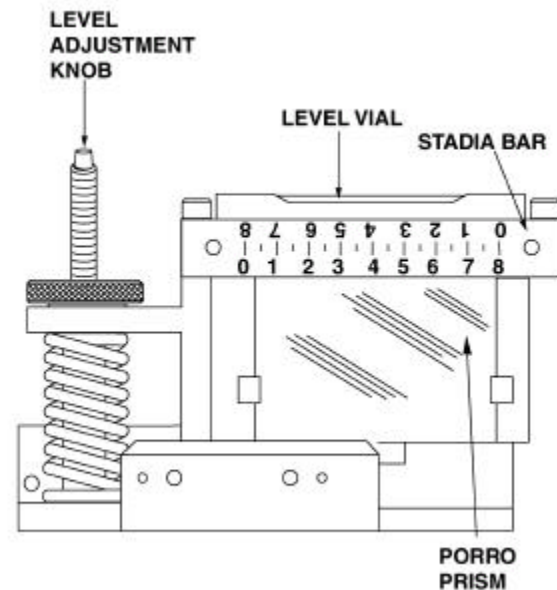

Figure 8-7. Porro Prism Components.

The level adjustment knob levels the porro prism. The level vial indicates the level of the porro prism.

Use the stadia scale with the theodolite stadia lines to indicate the distance between the porro prism and the theodolite to the nearest 0.1 meter.

Use the plumb bob arm assembly for marks and updates when mounted in a vehicle that uses the standard plumb bob position (M151, OH-58).

Recording the PADS Field Notes

The PADS survey data is recorded in the current version of the field recorder's notebook. As with all field notes, the first page of the recorder's book is

the index. Heading and column titles for normal PADS missions will be filled out as described below. See figure 8-8.

Fill out the designation block with PADS SURVEY.

Fill in the date block with the date the field work was performed.

In the heading of the following page, include the PADS serial number (taken from the primary pallet), ellipsoid, and datum. At the right side of that page, list the names of the operator and assistant operator and the interval that Z-Vels were made.

Label the column titles under the heading from left to right as follows:

1, STA. Identify the update or marked stations.

2, ID #. Identify the storage position in the PADS computer for update and marked positions. The PADS Version 4 stores 50 positions; Core Memory systems loaded with Version 3 stores 30.

3, PAE. Identify the operation performed at each position.

4, U/A. Identify unadjusted and adjusted data.

5 and 6, EASTING. Identify the UTM grid zone and UTM easting of the position.

7 and 8, NORTHING. Identify the UTM northing of the position.

9, EL. Identify the elevation of the position.

10, GRID AZ. Identify the UTM grid azimuth between two marked points or to an optically sighted azimuth mark. The PADS with Version 4 software will adjust the azimuth;. Use only the unadjusted azimuth. If the azimuth recorded is true, then record TRUE in the block with the azimuth.

11, DIST. Identify the distance (in meters) between two marked stations or to identify the distance measured by an autoreflection.

12, REM. Identify any system malfunctions, magnetic azimuth checks, etc.

Recording the information obtained from the optical azimuth method is performed in the same manner as recording a one-position horizontal angle. Other

DESIGNATION: PADS SURVEY					DATE: 10 OCT 2000					
STATION	ID #	PAE	U	A	EASTING					
MORGAN	1	U - U			17	652	352.5			
CC001 EOL	2	2 - 2	U		17	653	341.4			
			A		17	653	341.0			
CC001 OS	3	222	U		17	653	302.4			
			A		17	653	301.9			
RADAR OS	4	111	U		17	653	834.1			
			A		17	653	833.1			
SCP KNOX	5	U - U	U		17	654	294.9			

PADS SER #: #0198		PADS OPR: SGT JONES		9
ELLIPSOID: CLARKE 1866		ASST OPR: PFC SMITH		
DATUM: NAD27		Z-VEL TIME: 10 MIN		
NORTHING	EL	GRID AZ	DIST	REM
38 90	516.4	114.3		
38 89	365.1	134.1		
38 89	365.4	133.7		
38 89	258.1	134.8	3556.66	113.2
38 89	258.5	134.2		
38 88	068.8	113.2	3074.90	14.4
38 88	069.8	112.0		
38 84	227.8	107.8		7.3

Figure 8-8. The PADS Recording Procedures.

The PADS must be within 100 meters of the initialization site. Elevation should be within 10 meters. Initialization can be done using a GPS position when no survey control is available. This procedure cannot be performed with a theodolite.

The PADS should be level to $\pm 5^\circ$. The PADS can be initialized on slopes greater than 5° but with a possible decrease in alignment accuracy. LEVEL will display on the CDU. The operator should shut down the PADS, wait 2 minutes, move to a more level position, and reinitialize. If this is not possible, the PADS will continue to initialize until it reaches mode 8. LEVEL will go off and the GO light will flash.

Once the PADS is turned on it must not be moved for at least 1 minute or damage may result. Face the vehicle into the wind and allow it to set without moving for about 30 to 45 minutes. Once the PADS reaches mode 8, the GO indicator flashes informing the operator it can be moved.

Updating

This procedure tells the PADS exactly where it is. Perform it before marking a position. If adjusted data is needed it must be performed after marking positions. All updates are stored as ID numbers in the PADS memory.

Updating the PADS should be done while plumb over a fourth order or higher survey control point. However, a GPS position can update if no survey control is available. The PADS will not adjust stations that were marked before or after a GPS update. If you update over a survey control point, then mark stations and update with a GPS position, the stations marked between the two updates will not be updated.

The PADS can be updated with the programmed lever arm or with a theodolite (autoreflexion). If autoreflexion is used, the PADS must be within 16 meters of the station.

The position and elevation can be updated together or separately depending on what survey data is available. Azimuth cannot be updated.

Mark

This procedure obtains the position and elevation of a point; e.g., OS, EOL or OP. It also obtains an azimuth

between two marked stations (two-position mark) or between a marked station and an offset station (optical azimuth method). All marked positions are stored as ID numbers in the PADS memory.

When performing a two-position mark, the first position mark is performed the same as a regular mark with the PADS lever arm or the theodolite. The second position must be marked with the PADS vehicle. The PADS will not allow the second position to be marked with a theodolite. The distance between the two stations must be between 100 and 1,000 meters. Otherwise an error (E) will appear in the PAE portion of the mark. For more information on PADS procedures, see Marine Corps TM 08837A-12/1A/ Army TM 5-6675-308-12.

PAE Codes

Each time a station is marked or the PADS is updated, that station occupies one of 50 ID numbers stored in the mark portion of the PADS memory. Part of that ID number is the PAE, which tells the operator the method used to mark or update and whether or not that procedure was performed without error.

A separate code is assigned to each part of the PAE. These codes are displayed on the CDU after the mark is completed or after the update is accepted by the PADS. The display appears on the CDU as "ID #PAE XYZ where X represents the code assigned to Position, Y to Azimuth, and Z to Elevation." The three codes can be the same, different or any combination. See figure 8-10.

PAE CODE	MEANS
U	Position and/or elevation updated using a plumb bob or a theodolite over a control point.
g	Position and/or elevation updated using GPS only.
d	Position and/or elevation updated using Diff GPS.
1	Theodolite marked PAE.
2	Plumb bob marked PAE.
E	Error may exist in position, azimuth, and/or elevation.
-	PAE not updated or not marked.

Figure 8-10. PAE Codes.

A g or d with a 1 or 2; e.g., g1, d2 may appear in one of the PAE positions. This indicates that a mark has been affected by using a GPS or Diff GPS method. A g or d with a 1 indicates a GPS or Diff GPS association

with a theodolite mark. A g or d with a 2 indicates an association with a plumb bob mark.

Figure 8-11 shows examples of PAE readings the operator may see.

DISPLAY	MEANS
PAE U-U	Position and elevation updated.
PAE U--	Position only updated.
PAE --U	Elevation only updated.
PAE g-g	Position and elevation updated using GPS only.
PAE g--	Position only was updated by GPS.
PAE d-d	Position and elevation updated with Diff GPS.
PAE d--	Position only updated with Diff GPS.
PAE --d	Elevation only updated with Diff GPS.
PAE 1-1	Position and elevation marked using a theodolite.
PAE 111	PAE marked using a theodolite. Azimuth obtained by optical azimuth method.
PAE 2-2	Position and elevation marked with a plumb bob.
PAE 222	PAE marked with a plumb bob. Azimuth obtained by a two-position mark.
PAE 2E2	Position and elevation marked but the azimuth may be in error. This normally occurs when the distance between two stations in a two-position mark is less than 100 meters or too much time was used to travel between stations.
PAE g1-g1	GPS-influenced position and elevation marked with a theodolite. This will occur when the last update was performed with a GPS position.
PAE g2-2	GPS-influenced position from a plumb bob marked with a standard control elevation mark. This may occur if the last position update was performed with GPS and the elevation was updated separately over a survey control point.

Figure 8-11. Example of PAE Readings.

CHAPTER 9. GLOBAL POSITIONING SYSTEM

SECTION I. CONFIGURATION, SIGNALS, AND CODE

The Navigation Satellite Timing and Ranging (NAVSTAR) GPS is configured into space, control, and user segments. Each segment depends upon the other. See figure 9-1.

Originally, the complete space segment was to consist of 24 Block II satellites. Block I satellites were considered developmental. Block IIR (Replacement) satellites are being developed to provide system operations through

the year 2025. More than 24 satellites are currently in orbit. They are arranged into six orbital planes, each inclined 55° from the Equator. Each orbital plane contains at least four unevenly spaced satellites orbiting the Earth twice a day at an altitude of 10,898 miles. Satellites move continuously through their orbit in the same direction as the Earth's rotation. They orbit the earth twice in 23 hours, 56 minutes, and 04.091 seconds solar time or 1 24-hour sidereal day.

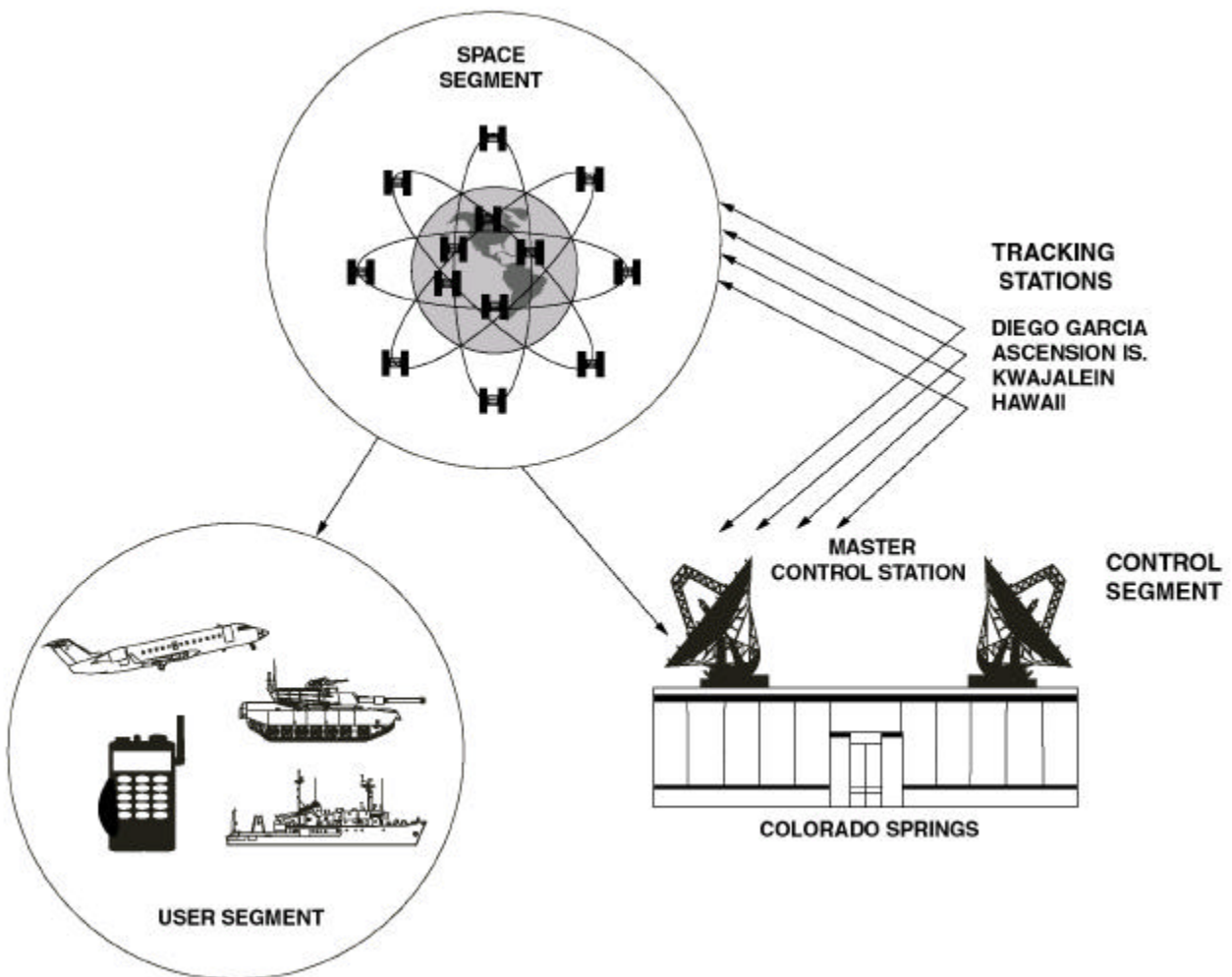

Figure 9-1. NAVSTAR System Configuration: Space, Control, and User Segments.

The control segment consists of five unmanned monitor/tracking stations located in Hawaii, Colorado, Ascension Island, Diego Garcia, and Kwajalein. Tracking stations use special receivers to track each satellite individually. The information from tracking the satellites helps control the satellites and predict their orbits. Three of the stations transmit information back to the satellites. All data collected at the tracking stations is transmitted to the master control station, located at Colorado Springs, Colorado where it is processed and analyzed. Ephemerides, clock corrections, and other message data are then transmitted back to the three stations for subsequent transmittal back to the satellites. The master control station is also responsible for the daily management and control of the satellites and the overall control segment.

The user segment consists of any one with a GPS receiver. Military and civilian personnel (including the enemy) use these receivers.

Satellite Signals

See figures 9-2 through 9-5.

Carrier Frequencies

Each GPS satellite broadcasts signals on two spread-spectrum radio frequencies (RFs). These are termed carrier frequencies because they are modulated with signal codes “carried” on the radio wave. The satellite’s onboard atomic clocks generate a

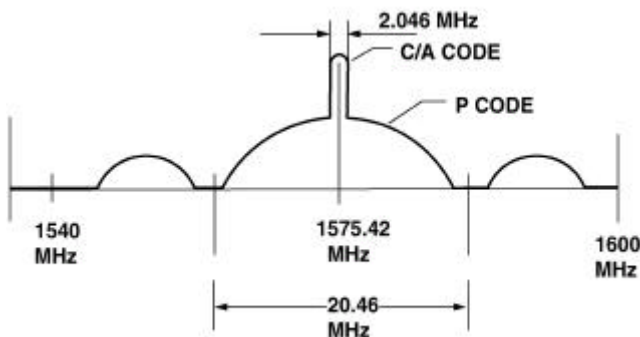

Figure 9-2. L1 Carrier Frequency.

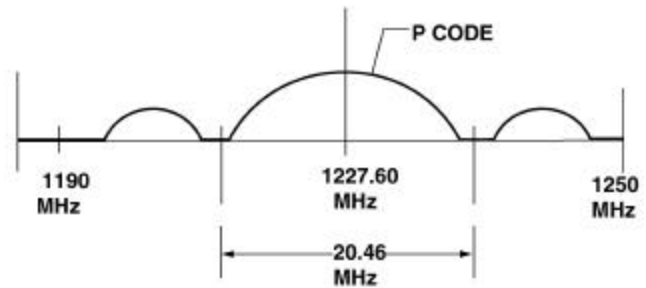

Figure 9-3. L2 Carrier Frequency.

fundamental frequency of 10.23 megahertz (10,230,000 cycles per second) multiplied by a factor that produces the actual carrier frequency.

The Link 1 (L1) RF carrier frequency is generated by multiplying the fundamental frequency by 154. It is centered at 1575.42 megahertz and has a bandwidth of 20.46 megahertz. The majority of the intensity of the signal lies at 1575.42 megahertz (± 10.23 megahertz). Signal wavelength is 19 centimeters.

The Link 2 (L2) RF carrier frequency is generated by multiplying the fundamental frequency by 120. It is centered at 1227.60 megahertz and has a bandwidth of 20.46 megahertz. The majority of the intensity of the signal lies at 1227.60 megahertz (± 10.23 megahertz). Signal wavelength is 24 centimeters.

Data Sequences

Each GPS satellite develops several binary data sequences transmitted from the GPS control segment. These sequences are the coarse/acquisition (C/A) code, the precise (P) code, and the Navigation Data Message (Nav Data).

The CA code is sometimes referred to as the standard (S) code. It has also been called the clear access or civilian access code. It is broadcast by all GPS satellites on the L1 carrier wave. Transmission of the data sequence is centered at 1575.42 megahertz (L1 frequency). It is modulated at ± 1.023 megahertz providing a bandwidth of 2.046 megahertz. The code contains a sequence of 1,023 pseudo-random binary biphasic modulations on the GPS carrier at a chipping rate of 1.023 megahertz, thus having a repetition period of 1 microsecond. The C/A code is a 300-meter measurement wave.

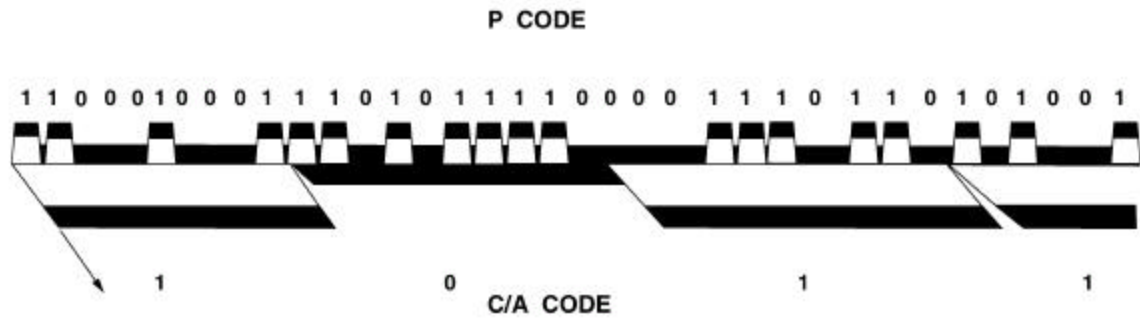

Figure 9-4. P Code and C/A Code Data Sequence.

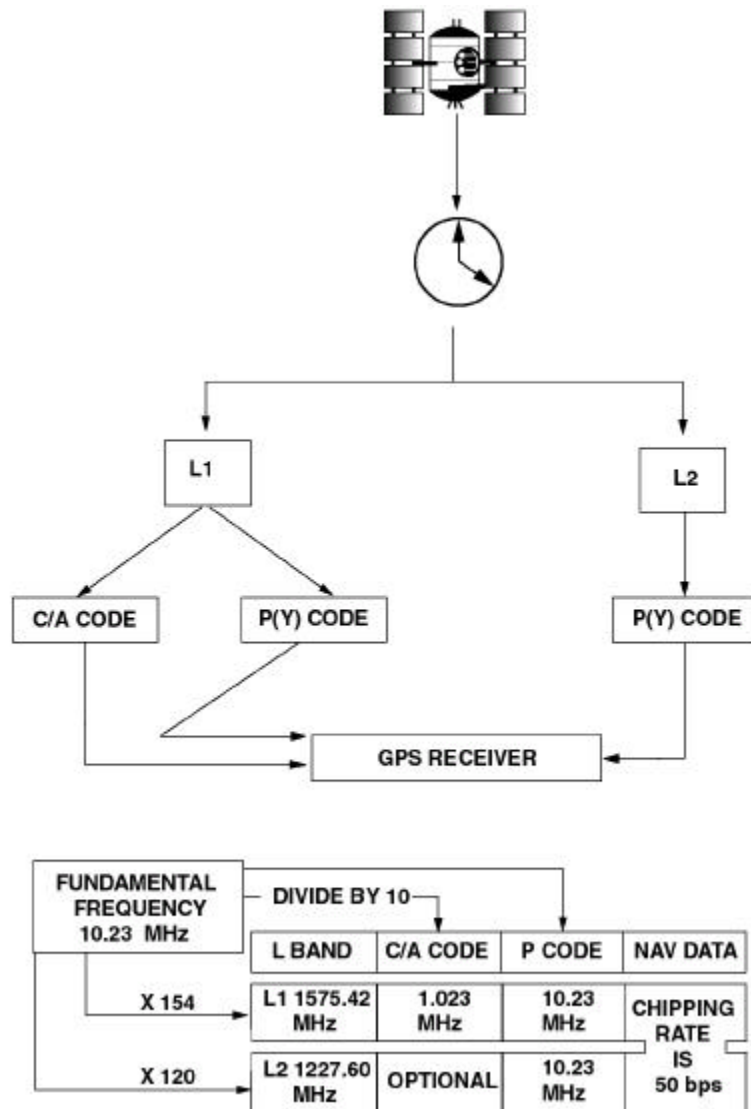

Figure 9-5. GPS Signal Data Flow.

The P code is sometimes referred to as the protected code. It is broadcast by all GPS satellites on both the L1 and L2 carrier. Transmission of the data sequence is centered at 1575.42 megahertz on the L1 carrier and at 1227.60 megahertz on the L2 carrier. It modulates at ± 10.23 megahertz on carrier frequencies providing a bandwidth of 20.46 megahertz. The P code is a 30-meter measurement wave and can be encrypted by the satellite creating a Y code.

The overall P code is a mathematically derived binary sequence that is 267 days (approximately 37 weeks) long. It is broken into 1-week segments for operational use. Five of these 1-week segments are reserved for the GPS control segment. The other 32 segments are available for satellite vehicles (SVs). Each SV has a unique 1-week segment code that is a subset of the overall P code sequence. It is generally accepted that the P code repeats every week.

The Nav Data is a 1,500 bit navigation message broadcast on both L1 and L2 carriers at a rate of 50 bits per second or 50 hertz. The Nav Data contains system time, clock correction parameters, ionospheric delay model parameters, and the almanac (ephemeris and health data) on the entire constellation. It is broadcast once each hour by each GPS satellite and can be referred to as the D code.

The Nav Data is a separate binary data sequence in the satellite. But it is modulated over the C/A and P codes for transmission. Each satellite develops the binary code sequence of the C/A code, the P code, and the Nav Data. Since these sequences are all 1's and 0's, the satellite combines the Nav Data with the C/A code and P code to form two data streams: one a

combination of the C/A code and the Nav Data, the other a combination of the P code and the Nav Data. These codes are actually transmitted on the carrier frequencies. The ground receiver then extracts the Nav Data from the broadcast C/A or P code, whichever it was receiving.

Ephemeris and Almanac Data

Each GPS satellite transmits almanac data once an hour. The almanac data is the position and health status of all satellites in the constellation. The ephemeris is the position data for each individual satellite. There are two types of ephemeris data to be considered: broadcast and precise.

The broadcast ephemerides are actually predicted satellite positions transmitted as part of the Nav Data. Ephemerides can be acquired in real time by any receiver capable of acquiring the C/A or P codes. Broadcast ephemerides are computed by the master control station using past tracking data provided from the five tracking stations. The new orbital parameters are then transmitted back to the satellites once every 24 hours for subsequent transmission to the user segment.

Precise ephemerides are computed from actual tracking data post-processed to obtain more accurate satellite positions. Precise ephemerides are available later and are more accurate than broadcast ephemerides because they are based on actual tracking data and not predicted data.

SECTION II. SYSTEM SAFEGUARDS, ERROR SOURCES, AND SURVIVABILITY

Selective Availability

When the concept of GPS was initially developed, it was planned that the P code would be reserved for military use, while the less accurate C/A code would be authorized for use by anyone. During initial system

testing, it was discovered that while P code measurements provided the expected 10-20 meter accuracy the C/A code provided accuracy as high as 20 meters (much better than the expected 100 meters). The DOD, expecting much lower accuracy, determined that a method of introducing errors into the satellite signals was needed to ensure that enemy forces would not be

able to obtain high position and timing accuracy from GPS. Selective availability (SA) was the outcome.

Methods

The DOD uses SA to deny precise position and timing accuracy to unauthorized users. SA uses two methods to intentionally introduce errors into the signals transmitted to the user segment.

The dither method alters or manipulates the satellite clocks. This method intentionally introduces timing errors, which ultimately produces position errors at the receiver because of the importance of accurate time to the computation of the pseudo-range.

The epsilon method alters the orbital parameters (satellite position) that are broadcast in the Almanac portion of the Nav Data. Position error is then created because the receiver is positioned based on the satellite location.

Accuracy Levels

The level of accuracy achieved by a GPS receiver now depends on if the receiver is equipped with an encryption device that allows the receiver to accept and store crypto variables referred to as a key. This key allows the receiver to decrypt SA correction data that is transmitted in the Nav Data message. This key also allows the receiver to use the encrypted P code. The two accuracy levels are the precise positioning service (PPS) and the standard positioning service (SPS).

The PPS is a precise positioning and timing service that is reserved for the US and allied military, as well as, specific authorized civilian users as long as their receiver accepts the crypto key discussed above. The technical specification is listed at 16 meters spherical error probable (SEP).

The SPS is the less accurate positioning and timing service offered to all GPS users. The DOD has stated that this service will be accurate to 100 meters in horizontal position and 150 meters vertical, under normal conditions, 95% of the time. The DOD does have the ability to increase the errors created by SA based upon national security needs.

Antispoofing

Antispoofing (S) is a method used by the DOD to prevent possible hostile imitations of the GPS signal. Encrypting the P code creates the Y code, which can only be processed by GPS receivers with a valid crypto key. This encrypted code is very difficult to imitate. It is important to understand that the P code and the Y code are not two separate codes; one is the encrypted version of the other. A GPS receiver without a valid crypto key cannot process the Y Code and will be limited to measurements from the C/A code.

Cryptovariables

As stated before, cryptovariables are necessary for a GPS receiver to access the Precise Positioning Service, allowing the receiver to correct for errors caused by SA and AS. It is unauthorized to use a military GPS receiver without a valid crypto fill.

There are three types of key materials available for use with a GPS receiver: operational, maintenance, and simulator. There are three formats for key loading: the KOI-18 General Purpose Tape Reader, the KYK-13 Electronic Transfer Device (capable of loading multiple keys), and the AN/CYZ-10 Data Transfer Device (DTD).

Operational Key Material

Two operational cryptographic keys (group unique variable [GUV] key and cryptovariable weekly [CVW] key) are available for issue to a GPS user. Both keys can be used by a receiver to obtain a daily cryptovariable key (CVd). All operational keys are classified CONFIDENTIAL and are marked CRYPTO.

The GUV key is an annual key. It is a key encryption key (KEK) that decrypts previously encrypted daily keys. A GPS receiver loaded with a GUV key takes longer to begin processing navigational data than the weekly key because it must first acquire and decrypt the CVd key being broadcast by any GPS satellite. This process could take as long as 12.5 minutes after initial GPS signal acquisition. The GUV key is not a

years worth of daily keys. It is merely the data needed by the receiver to decrypt the broadcast daily key.

The cryptovisible weekly (CVW) key is sometimes referred to as the crypto key weekly (CKW). It is a key production key (KPK) that automatically generates daily keys within the user equipment. Obtaining the daily key from a satellite downlink is not necessary for receivers loaded with a CVW key. A user with a CVW key starts processing navigational data in less time than those with a GUV key. Because of this special capability, distribution of the CVW key is limited to those users who demonstrate a valid need for initial GPS acquisition in a minimal amount of time.

The GUV key and the CVW key will produce the same CVd key. Once the receiver determines the current working CVd, processing navigational data may commence and the effects of SA and AS can be removed from the GPS signal and full navigational accuracy is restored. A CVd cannot be entered directly into the receiver, only a CVW or a GUV key can be entered. The same CVd is used for both SA and AS.

Maintenance Key Material

A maintenance key is available to users for troubleshooting GPS user equipment. It does not allow a user to gain access to the daily encryption key. Maintenance keys are unclassified and may be reused until they are unusable.

Simulator Key Material

A simulator key is available to users for testing receivers. The simulator and the equipment must be keyed with the simulator key. The simulator key does not allow a user to gain access to the daily encryption key. Simulator keys are unclassified and may be reused until they are physically unusable.

User Equipment Security

Because of the security classification of the CVW and GUV keys, GPS receivers designed specifically for military uses are equipped with a special certified security module that prevents the extraction of cryptographic information from the receiver. These receivers can then remain unclassified even when loaded with a cryptographic key. If classified

information other than crypto is stored in the receiver, the receiver becomes classified at the level of the stored information.

GPS Error Sources

There are many sources of measurement error that influence GPS performance. The sum of all systematic errors or biases contributing to the measurement error is referred to as range bias.

The observed GPS range (the range from the satellite to the receiver) without the removal of biases is called a pseudo-range. Principal contributors to the final range error that also contribute to overall GPS error are ephemeris error, satellite clock and electronic inaccuracies, tropospheric and ionospheric refraction, atmospheric absorption, receiver noise, and multipath effects. Other errors include those induced by the DOD (SA and AS). GPS also contains random observation errors, such as unexplainable and unpredictable time variation. Due to their random nature, these errors cannot be modeled and corrected. The following paragraphs discuss these errors as they associate with GPS positioning and navigation. Most are eliminated or their effects significantly reduced when GPS is used in a differential mode. (The same errors are common to both receivers during simultaneously observed sessions.)

Ephemeris Errors and Orbit Perturbations

Satellite ephemeris errors are errors in the prediction of the satellite position that are transmitted to the user in the Nav Data. Ephemeris errors are satellite-dependent and very difficult to predict and compensate. The many forces acting on the predicted orbit of a satellite are difficult to measure directly.

Clock Error

GPS relies heavily on accurate time measurements. GPS satellites carry rubidium and cesium time standards that are usually accurate to 1 part in 10^{12} and 1 part in 10^{13} , respectively. Most receiver clocks are actuated by a quartz time standard accurate to 1 part in 10^8 . The difference between the satellite time and the receiver time is called the time offset. The product of

the time offset and the speed of light equal the possible error due to clock bias as—

$$R_E = T_Oxc$$

when R_E is the range error due to clock bias.

T_O is the time offset.

C is the speed of light (299,792,458 m/s).

For example, if the time offset is 1 microsecond (10^{-6}) then the $R_E = 10^{-6} \times 299,792,458 = 299.8$ meters.

Ionospheric Delays

GPS signals are electromagnetic signals that are dispersed nonlinearly and refracted when transmitted through a highly charged environment, such as the ionosphere. Dispersion and refraction of the GPS signal is referred to as an ionospheric range effect. (The dispersion and refraction of the signal results in an error in the GPS range value.) Ionospheric range effects are frequency dependent. L1 and L2 frequencies are affected differently even though they follow the same path through the ionosphere.

The error effect of ionospheric refraction on the GPS range value depends on sunspot activity, time of day, and satellite geometry. Periods of high sunspot activity produce greater range errors than periods of low sunspot activity because of the effects of the Sun's gravity on the ionosphere. Daylight GPS operations will produce greater range errors than night operations. GPS operations with satellites near the horizon will have larger range errors than those with satellites near the zenith. (The signal must pass through a larger portion of the ionosphere when the satellite is near the horizon.)

Resolution of ionospheric refraction can be accomplished with the use of a dual frequency receiver (L1/L2). During a period of uninterrupted observation of the L1 and L2 signals, the signals can be continuously counted and differenced. The resultant difference reflects the variable effects of the ionosphere delay on the GPS signal. Single frequency receivers in the absolute and differential positioning modes normally rely on an ionospheric model that

model the typical ionosphere. Use of these models can remove a significant amount of the ionospheric delay.

Tropospheric Delays

GPS signals are not dispersed by the troposphere but they are refracted. Tropospheric conditions causing this refraction can be modeled by measuring the dry and wet components.

The dry component can be modeled easily through measuring the surface pressure using the equation—

$$D_c = (2.27 \times 0.001) \times P_o$$

when D_c is the dry term range contribution in zenith direction in meters.

P_o is the surface pressure in millibars.

Example: if the surface pressure is 765 millibars then the dry term range error is $(2.27 \times 0.001) \times 765 = 1.73655$ or 1.7 meters.

The wet component cannot be so easily modeled. The wet component is approximated by not only surface conditions, but by atmospheric conditions along the entire path of the GPS signal (water vapor content, temperature, altitude, and the angle of the signal path above the horizon).

Multipath

Multipath is a positioning error caused by the signal arriving at the receiver from more than one path. Generally, this is due to the receiver being located near a reflective surface such as a metal building or structure. Newer antenna designs have some filtering capabilities to reduce the effects of multipath. However, proper mission planning and site reconnaissance is the best way to reduce this type of error. Averaging of GPS signals over a period can also reduce multipath effects.

Receiver Noise

This error source includes a variety of errors associated with the receiver's ability to measure a finite time difference. Errors include signal processing and filtering, clock/signal synchronization and

correlation methods, receiver resolution, signal noise, and electronic interference. Most errors cannot be modeled or accounted.

User Equivalent Range Error

User equivalent range error (UERE) can be referred to as the total budgeted error caused by the error sources listed above. Many of these error sources can be reduced through planning or using L1 or L2 antennas. Differential techniques can even eliminate some of these error sources. Figure 9-6 lists these errors and biases by associating them with their source segment. Error values in this figure do not include the effects of SA.

Absolute GPS Accuracy

Absolute positions are those that are established with no reference or tie to any other station. They are sometimes referred to as autonomous. For GPS purposes, this is generally accomplished by use of code-phase measurements to determine a pseudo-range. The accuracy of these ranges depends largely on the code (C/A or P(Y)) being used to determine the position. This range accuracy (UERE) when coupled with the geometrical relationships of the satellites results in a 3-dimensional confidence ellipsoid that depicts uncertainties in all three coordinates. Since satellites are constantly moving, the geometry constantly changes. GPS accuracy is time/position-dependent.

Segment Source	Error Source	Absolute, C/A code Pseudo-range, m	Absolute, P(Y) code Pseudo-range, m	Differential Positioning, m P(Y) code
Space	Clock Stability	3.0	3.0	Negligible
	Orbit Perturbations	1.0	1.0	Negligible
	Other	0.5	0.5	Negligible
Control	Ephemeris Predictions	4.2	4.2	Negligible
	Other	0.9	0.9	Negligible
User	Ionosphere	3.5	2.3	Negligible
	Troposphere	2.0	2.0	Negligible
	Receiver Noise	1.5	1.5	1.5
	Multipath	1.2	1.2	1.2
	Other	0.5	0.5	0.5
I_0 UERE		± 12.1	± 6.5	± 2.0

Figure 9-6. User Equivalent Range Error.

Root-Mean-Square Error Measures

The two-dimensional (2-D) (horizontal) GPS position accuracy is normally estimated using a root mean square (RMS) radial error statistic called standard deviation or sigma (σ). A 1-RMS (one sigma) error equates to the radius of a circle in which the position has a 63 percent probability of falling. A circle twice this radius represents an approximate probability of 97 percent. This is a 2- σ RMS or 2DRMS (2-deviations RMS) and is the most commonly used accuracy statistic in GPS survey. In some instances, a 3- σ RMS (3DRMS) depicts a circle three times the radius of the 1- σ circle. This circle has a 99.7 percent probability. An RMS error statistic represents the radius of a circle and is not listed with a \pm .

Figure 9-7 depicts RMS on an error ellipse at 2- σ . This ellipse represents a normal distribution of GPS position errors and is centered at the indicated position of the receiver. The radii of an error ellipse are expressed in standard deviation (sigma (σ)) of the

position distribution and usually provide a direction such as Sigma North, Sigma East, and Sigma Up. Each sigma is a probability estimate of how close the actual position is to the displayed position as discussed.

Probable Error Measures

In 2-D horizontal positioning, a circular error probable (CEP) statistic is most commonly used, especially in military targeting. CEP refers to the radius of a circle with a 50 percent probability of position confidence. A measured or calculated position will fall inside a circle of some radius at least 50 percent of the time.

Three-dimensional (3-D) GPS accuracy is most commonly expressed as a spherical error probable (SEP). This value represents the radius of a sphere with a 50 percent confidence level or probability. It is important to understand that this sphere only approximates an actual 3-D-error ellipsoid that represents the uncertainties in the geocentric coordinate system.

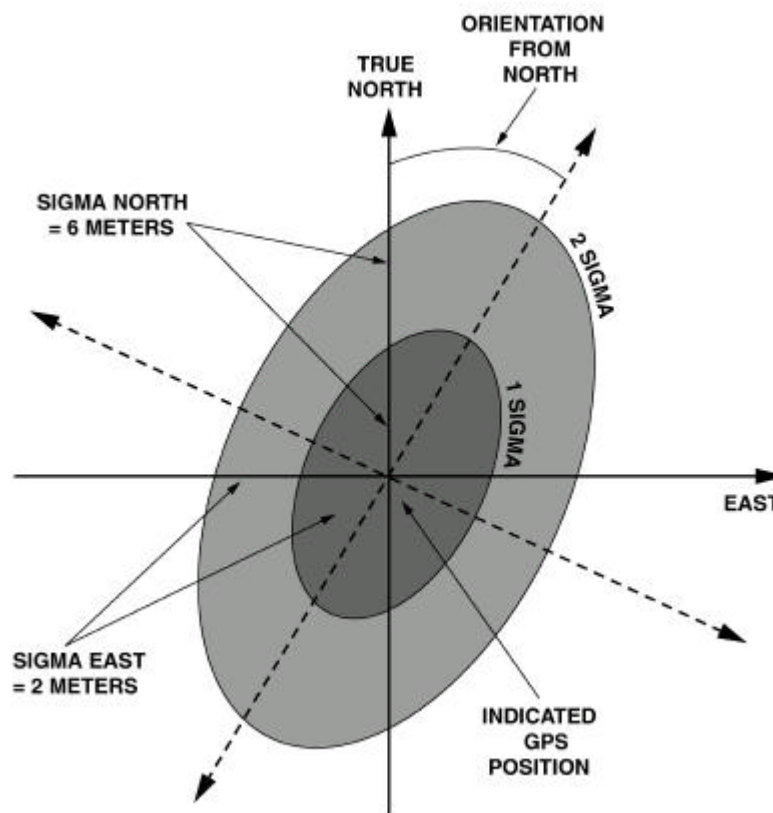

Figure 9-7. Error Ellipse at 2- σ RMS.

Dilution of Precision

Dilution of precision (DOP) is a scalar quantity representing the contribution or effect of the satellite geometry to the GPS accuracy. It is the ratio of the standard deviation of one coordinate to the measurement accuracy. It could be said that DOP is the measure of the strength of the satellite geometry. In general, the more satellites that are observed and used in the final solution, the better the solution. Since DOP can be a measure of geometric strength, it can also determine the satellites a receiver uses to determine the most accurate position.

Satellite geometry and DOP can best be visualized by the following analogy. A rubber ball is suspended from five strings. All five strings are attached at the other end to the ceiling within a couple of meters of each other. Because of poor geometry of the strings' attachment to the ceiling, the ball can be moved easily. A large portion of the possible error in the position of the ball is due to poor geometry or high DOP. On the other hand, if the ball was still attached to the same strings but four of the strings were attached to the ceiling at the four corners of the room and the fifth string attached directly above the ball, the ball would not move so easily. This would be due to strong geometry. The DOP would be small.

The main form of DOP used in measuring absolute accuracy is the geometric DOP (GDOP). GDOP is the measure of accuracy of 3-D position and time. GDOP is related to actual range error by stating that the actual range error equals the GDOP multiplied by the UERE.

Position dilution of precision (PDOP) is the measure of the accuracy in 3-D position only. PDOP values are generally developed from satellite ephemerides prior to the conduct of survey operations. The surveyor can more adequately plan sessions and occupations for his equipment.

PDOP represents the position recovery at a particular instance in time and is not representative of the entire session. PDOP error is generally given in units of meters of error per 1-meter error in pseudo-range measurement; i.e., m/m. If the pseudo-range measurement due to clock errors, atmospheric conditions, etc., is in error by 2 meters and the PDOP is 5.5, the possible position error due to satellite geometry is 11 meters. When using pseudo-ranging techniques for

absolute positioning (code phase), PDOP values lower than 5 m/m are considered very good; values greater than 10 m/m are very poor. For static-type surveys, it is desirable to make observations during periods of rapidly changing PDOP.

When the values of PDOP and GDOP are observed over time, high values (> 10 m/m) can be associated with poor geometry. The higher the PDOP the poorer the solution for that instant in time. Poor geometry can be the result of satellites being in the same plane, orbiting near each other or at similar elevations.

Horizontal dilution of precision (HDOP) is a measurement of the accuracy in 2-D horizontal position. It is significant in evaluating surveys intended for horizontal control. Basically, HDOP is the RMS position error divided by the standard error in the range measurements. It roughly indicates the effects of satellite range geometry on a resultant position. HDOP values lower than 3 indicate the best geometry.

Vertical dilution of precision (VDOP) is a measurement of the accuracy in standard deviation (σ) in vertical height. Mathematically, it is the σ_u (Sigma Up) divided by UERE (around 6 meters with P(Y) code and 12 meters with C/A code). A VDOP value lower than 3 indicates a strong vertical component in the geometry.

Time dilution of precision (TDOP) is the measurement of the accuracy of the time determined by the GPS receiver.

GPS vulnerabilities are generally grouped by the segment they threaten.

Space Segment

The height of the GPS satellites (10,898 miles) is outside the range of current antisatellite weapons. Such space weapons would be deployed at lower altitudes where they could possibly be used against more attractive space-based systems. The constellation generally keeps the satellites approximately 44,000 kilometers apart in each orbital plane. The control segment manages the system so that no two satellites will orbit within 8,100 kilometers of each other. This spatial separation ensures that a single nuclear burst in

space at half the closest distance will have little effect, forcing a more direct assault against individual satellites. A ground-launched attack by antisatellites would be detected early enough in the 3-hour flight time to allow for maneuvering of satellites.

It is unlikely that current or projected technology would allow a nation to launch a direct attack or even detonate a nuclear device in the GPS orbit. A nuclear detonation in space would equally affect other space-based systems with a blackout or scintillation effect lasting 10 minutes or longer in the L-band. Detonation would disturb the atmosphere and the ionosphere with subsequent effects on propagation. Radiation effects could incapacitate the functioning of the erasable read only memories (EROMS) and random access memories (RAMS) of these systems if the blast is close enough. GPS satellites have built-in protection against the electromagnetic pulse (EMP) caused by nuclear detonations and can restore their erased memories through the control segment.

Two other factors exist that add an unplanned edge of survivability against antisatellites. The Russian Global Navigation Satellite System (GLONASS) orbits at an altitude close to the GPS orbit. A nuclear assault against GPS would have the same effect on GLONASS. The increased use of GPS by former Eastern Bloc nations including the former Soviet Union is also an unplanned edge.

Since the introduction of the Strategic Defense Initiative (SDI), lasers have become a planned vulnerability to orbiting satellites. Survivability of GPS against laser technology is enhanced by limited laser hardening of the satellites. A space-based laser at low altitudes would be an extremely heavy device to launch. Tracking and targeting of a GPS satellite is extremely difficult due to its relatively small size and its orbital rate (14,500 kilometers per hour). Technology is available for a high-power ground-based laser-to-target and has a limited effect on GPS satellites.

Should there be a loss of any GPS satellite, replenishment from the ground can be accomplished within 2 months. The system can operate fully even with the loss of 9 or more satellites, still providing 3-D coverage for 12 hours and 2-D coverage for more than 20 hours.

Control Segment

This segment is considered by many to be the most vulnerable GPS segment. The master control station (Colorado Springs) is very well protected by being collocated with several military bases. The tracking stations do not have this protection. All stations are susceptible to espionage and natural disasters, but tracking stations are much more vulnerable to nuclear and conventional assaults. These factors have been considered, and although the ability exists to exert complete control over the satellites from the master control station, the uplink to each satellite will be less frequent than the current 8 hours. Next-generation satellites are planned to provide a cross-link ranging capability that will allow satellites to communicate with each other, making offshore tracking stations redundant. Jamming the control segment between the tracking stations and the master control station is a real possibility.

User Segment

Only two major vulnerabilities exist with the user segment: cryptographic key security and jamming. Several types of jamming can be used against GPS receivers.

Cryptographic Key Security

Should the enemy capture a GPS receiver with a valid crypto fill, the PPS-security module prevents reverse engineering so that the enemy cannot gain access to the cryptographic data stored inside the receiver. Also, the regular change of crypto keys adds to the security and survivability of the system.

Spoofing

Spoofing is classified as the enemy's attempts to duplicate or imitate GPS signals. Spoofing requires that the enemy have a knowledge of the received satellite phase and frequency at the targeted receiver antenna. The proper carrier frequency and timing code phase plus a sufficiently higher power output will allow a deceptive jammer to establish a false lock with the receiver. The enemy must know which satellites

are being tracked and the position and velocity of the receiver to create a false signal with the correct Doppler shift. Once false lock is established, the spoofer can perturb the duplicated navigation signals to cause navigation errors.

When GPS antispoofing protection is enabled, spoofers cannot autonomously generate the signals needed to deceive the receiver that is looking for the encrypted P code. This technique transforms the P code by cryptographic means. The resultant bit stream is a cypher text called the Y code that replaces the P code in its entirety. Receivers with a valid crypto key will encrypt their own generated P code to produce a Y code inside the receiver needed for correlation with the satellites transmitted Y code. The C/A code is totally unaffected by the P code encryption. This is why the C/A code is very susceptible to deception jamming.

Continuous Wave Jamming

A continuous wave (CW) jammer (or spot jammer) concentrates its jamming power in a very narrow band around the L1 or L2 carrier. In the GPS receiver the jamming power spreads out according to the receiver processing gain using the modulated C/A or P code. After spreading, only a small portion of the jamming power enters the tracking loops of the receiver. Consequently, a CW (spot) jammer needs to be very powerful to effectively jam a GPS receiver.

Wide Band Jamming

A wide band jammer needs a sufficiently wide spectrum to cover the frequency band of the GPS signals. Usually, wide band jamming is performed in either a sweeping mode or a quasi-random noise (barrage) mode. In a sweeping mode the jammer carrier moves rapidly and possibly randomly through the band to be jammed. In barrage jamming the spectral power density is low compared to spot jamming.

Pulse and Amplitude Modulated Jamming

A pulse jammer switches its power on and off during an operation cycle. The modulation rate can be chosen as needed (pulse repetition frequency and pulse duration). An amplitude modulated jammer varies its power linearly; modulation depth and frequency can be chosen as needed. Besides jamming effects already

described, this type of jamming could have a negative impact on the GPS receiver by disturbing the internal operating cycles of the receiver processor unit or the electronics of the antenna.

Jamming Effects on Code Acquisition

The GPS user is at a severe disadvantage when having to use C/A code acquisition in a hostile region. Current technology receivers have a limited tolerance to jamming during C/A code acquisition (usually around 25 decibels). Although only 1,023 chips must be searched in the C/A code, a large frequency window must be searched to account for satellite and receiver Doppler shift. The receiver must maintain a large predetection bandwidth to acquire the C/A code at the expense of reduced jamming tolerance (J/S). The C/A code is widely disseminated. A smart jammer can broadcast a false signal and lock up the receiver with very low power. Tests indicate that a very modest 1-watt noise jammer prevents a receiver from acquiring the GPS signal using the C/A code out to 85 kilometers. If the jammer were to transmit a spoofing signal, the receiver would not be able to discriminate between the desired GPS signal and the spoofing signal. The receiver's jamming tolerance would be on the order of 0 decibels, a 1-watt spoofer could deny C/A code acquisition past 1,000 kilometers or to the jammer's horizon.

The P(Y) code is virtually impossible for an adversary to spoof because of its long length and the encryption of the P code into the Y code. Also, the P(Y) code has 10 decibel more antijam protection than the C/A code because of its 10 times larger bandwidth. Some current technology receivers using direct P(Y) code acquisition (hot start) can tolerate a J/S level in excess of 35 decibels. However, because the P(Y) code is so long, (6×10^{12} chips) much time or more correlators operating in parallel are needed for the two-dimensional search over code timing and Doppler frequency. Thus, up to date satellite ephemerides and accurate code timing must be available to effectively perform a hot start.

Reacquisition typically has very accurate initial code timing. If this accuracy is available during direct P(Y) code acquisition, the reacquisition problem is the same as the acquisition problem with increased J/S tolerance (in excess of 50 decibels depending on the receiver).

Antijam Capabilities of GPS

GPS vulnerability to jamming can never be completely eliminated. With constantly improving techniques and technology, higher power outputs by the enemy jammers is required to deny access to GPS signals.

The GPS satellites broadcast in the ultra-high frequency (UHF) domain. UHF signals cannot “go around” obstacles such as buildings, hilltops, large rocks, etc. the way low domain frequencies can. For this reason, ground based jammers are restricted by severe line-of-sight limitations. Air or space-borne jammers, obviously, are not so restricted. A smart user will position his GPS receiver to limit the effects of a line-of-sight jammer. Defilade areas that still allow open skies for satellite signals can be used. Handheld receivers can be placed in a “cat hole” or the user can simply turn his back to the suspected direction of the jammer. Once the receiver has a lock on the P(Y) code, the user should be able to operate normally in most jamming environments.

The satellite signal is a continuous wave type signal. This signal is spread by modulation and enters the receiver with the jamming signal. The original signal is recovered as the jammer energy is spread over the modulation and most of the jammer power is filtered out.

To locate, track, and demodulate a satellite signal, the receiver requires a certain minimum ratio between received signal power and the noise power. This value (or threshold) is referred to as the signal-to-noise ratio

(SNR). The noise power is dissipated over a wide bandwidth, while the satellite signal power is concentrated in a very narrow frequency band. Using filters, the GPS receiver narrows its bandwidth to the absolute minimum in order to receive the maximum signal power and minimum noise. A receiver can usually recognize the jammer power as noise; therefore, much of its effects are filtered out. Depending on the power output of the jammer, the SNR may be too high for the receiver to filter out enough noise to determine data.

Many other antijam capabilities exist for GPS. Among them is the inertial navigation system (INS) integration with GPS and high cost antennas. Both are used in military applications but generally with missile, rocket, and aircraft navigation technologies. For the most part, antijam capabilities for Marine ground units will be enhanced by proper planning and positioning of GPS assets.

The surveyor must be aware of the ambient conditions of the GPS satellites and their surrounding environment. Solar flares, occurring in 11-year cycles, send great fountains of electromagnetic energy and radiation deep into space, causing interferences in GPS signals. Meteor showers, such as the Lenoid event, occur close to the Earth, and could potentially damage satellites in the GPS constellation. GPS satellites are hardened against such possibilities, but are not invulnerable.

SECTION III. GPS MEASUREMENTS

GPS Reference System

The GPS satellites reference their own position to the WGS 84 coordinate system. This system is based on the WGS 84 ellipsoid. To fix the Earth in time and space for the development of the WGS 84 ellipsoid, the Conventional Terrestrial Pole of 1984 (CTP 84) was chosen. The position of the Earth's polar axis at 1984.0 as defined by the Bureau International De l'Heure (BIH) is used to define the z-axis of the WGS 84 cartesian coordinate system. The x- and y-axes are then

referenced to that z-axis. All positions determined by GPS are originally in this format, WGS 84 cartesian. Receivers and software applications for GPS have the capability to provide positions in other coordinate systems and other datum/ellipsoid references.

Code Phase Measurements

The primary purpose of code phase measurements is to determine approximate ranges from satellites to the

GPS receiver that allow the receiver to determine its position. Since this position is not referenced or relative to any other position or receiver, it is referred to as an absolute position. Clock biases, atmospheric absorption and refraction, and other inherent errors make determination of a true range virtually impossible. The actual range determined by the GPS receiver is referred to as a pseudo-range. See figure 9-8.

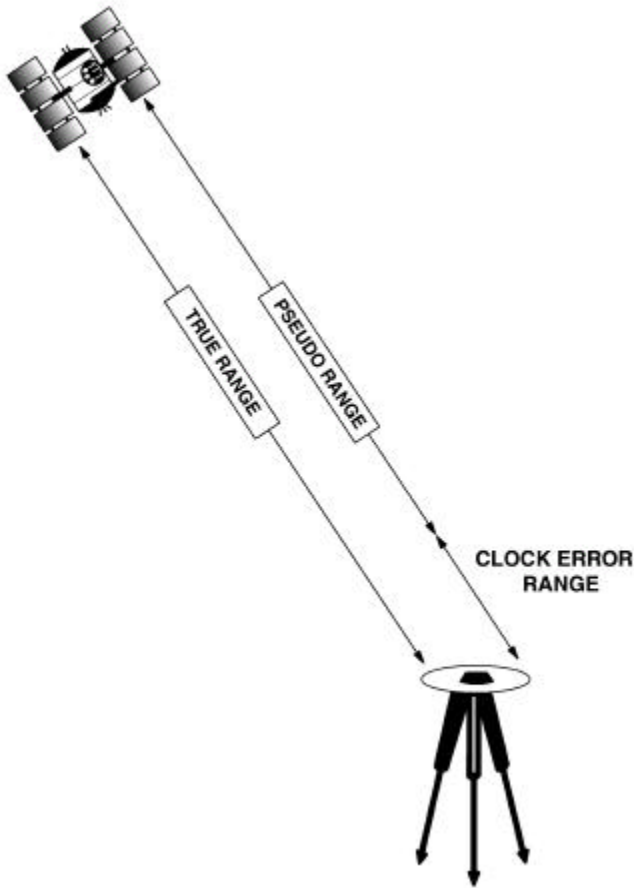

Figure 9-8. Pseudo-range.

Pseudo-random Noise Code

The Pseudo-random noise (PRN) code is a binary data string of digital ones and zeros that is unique to the satellite broadcasting it. This code is used by the receiver to identify the satellite it is tracking. This code is repeated every millisecond (C/A) and every week (P/Y). See figure 9-9.

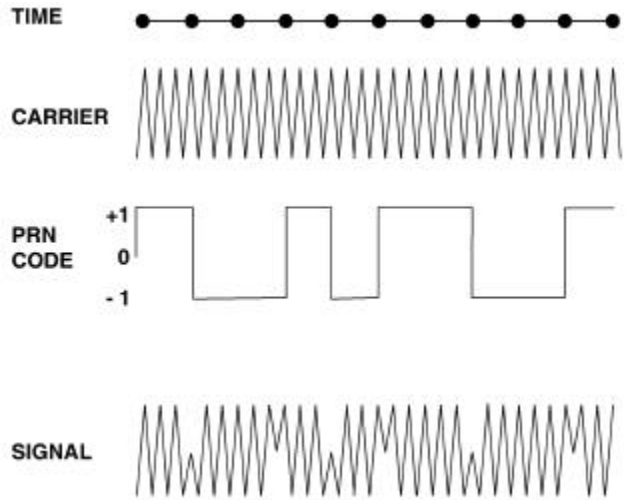

Figure 9-9. Carrier Modulated by PRN.

Time Delay

Before the receiver can compute the pseudo-range to the satellite, it must determine the time required for the signal to travel from the satellite to the antenna. The receiver stores a replica of each satellite’s PRN code. When the receiver detects a satellite signal, it identifies the satellite by its PRN that has been replicated from memory. The code received from the satellite is then compared to the replicated code. The receiver slides the replicated code in time until it lines up with the satellite’s transmitted code. The amount of time that was needed to slide the code is the time delay of the transmission or travel time. See figure 9-10.

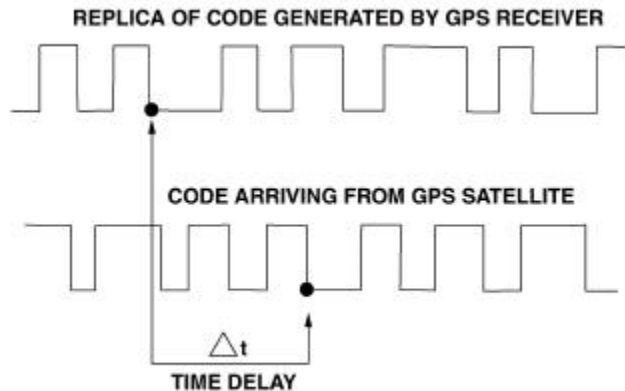

Figure 9-10. Time Delay of a GPS Signal.

Satellite Ranging

The only measurement made by a code-phase receiver is the time delay or transmission time. Radio waves travel at the speed of light. This constant value is stored in the memory of the GPS receivers. A receiver capable of making code-phase measurements will compute the pseudo-range using the formula $\text{pseudo-range} = \Delta t \times \text{speed of light}$.

This procedure can be simultaneously performed on many satellites. The number of satellites depends on the receiver used, or more specifically, how many channels are available in the receiver.

Once a satellite is tracked and the receiver determines a pseudo-range, the receiver basically knows it is located on a sphere whose radius equals the pseudo-range with the satellite at the center of the sphere. See figure 9-11.

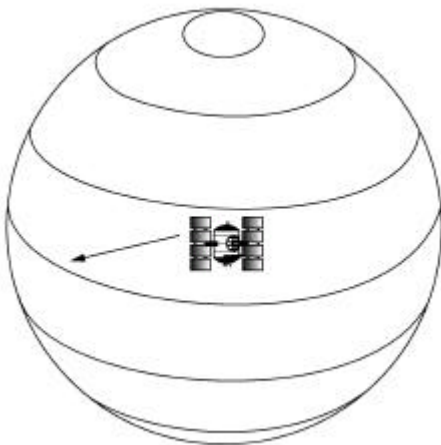

Figure 9-11. Ranging One Satellite.

When the second satellite is acquired, the same ranging technique is used creating a second sphere. The intersection of the two spheres is a circle. The receiver is located somewhere along the edge of that circle. See figure 9-12.

The third sphere determined by ranging a third satellite would intersect the circle created above at two points. The receiver knows that its position is referenced to the WGS 84 ellipsoid/datum. Only one

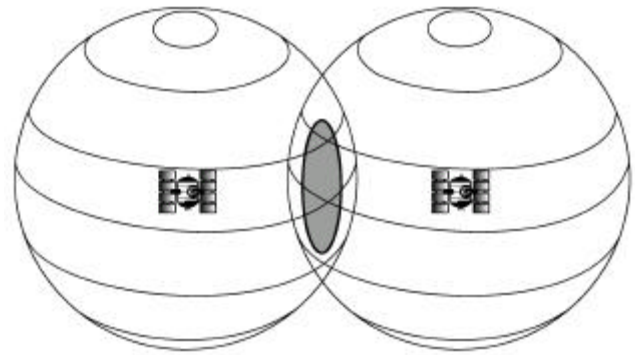

Figure 9-12. Ranging Two Satellites.

of the two points of intersection will be located on this geodetic system. The other point will be out in space, deep inside of the ellipsoid or moving at an extreme velocity. With three satellites, a receiver can provide a 2-D position. To achieve a 3-D position, at least four satellites must be ranged. The fourth satellite provides the timing data for the receiver to resolve timing errors in the system. See figure 9-13.

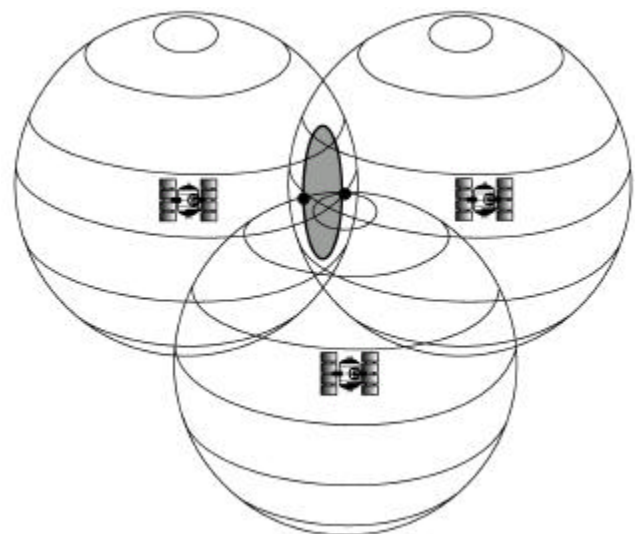

Figure 9-13. Ranging Three Satellites.

Carrier Phase Measurements

The primary purpose of carrier phase measurements is to determine ranges from satellites to receivers that will allow the receiver to position it. Usually these

positions are processed relative to another receiver position and are referred to as differential positions. Ranges to the satellites are pseudo-ranges, as in code phase. However, this method of ranging requires the solution of the integer ambiguity of the signal. The determination of this distance requires that the number of whole carrier wavelengths be known.

Integer Ambiguity

The whole number of wavelengths between the satellite and the receiver is known as integer ambiguity or cycle ambiguity. Since we know the L1 carrier wavelength is 19 centimeters long and L2 is 24 centimeters long, and since most carrier phase receivers can determine the partial wavelength to an accuracy around 2 mm; the pseudo-range can be accurately measured as long as we can determine the number of complete wavelengths between the satellite and receiver. This is done by comparing changes in the received frequency (caused by the Doppler effect) to the broadcast frequency over time.

Carrier (Beat) Phase

Carrier phase GPS receivers contain an internal oscillator that generates a carrier signal. This generated carrier signal is compared to the received signal from the satellite. The carrier phase observations (also called carrier beat phase) are determined from these measurements.

Continuous Carrier Phase

When the receiver first locks on to a satellite signal, it can only measure the fractional part of the wavelength. It has no knowledge of the number of full wavelengths at that specific point in time between it and the satellite. After that first measurement, the receiver will count the number of whole wavelengths it observes. This is the continuous carrier phase.

If the satellite signal is interrupted (see next para), the continuous carrier phase is reset. It is set to the next fractional wave measurement (carrier phase observable) immediately following the break.

Cycle Slips

A cycle slip is the interruption or break in the continuous carrier wave.

The wave fronts that are counted by the receiver during continuous phase tracking are called cycles. When the signal is interrupted, the continuous count of those wave fronts or cycles is broken, or the count slips. This cycle slip causes the continuous carrier phase to be reset. The baseline processor in most GPS-S systems can reestablish this count whether in a static or a kinematic mode.

Cycle slips can be caused by any number of barriers between the satellite and the receiver. These barriers can include terrain masks, trees, or even an operator standing between the satellite and the antenna. Cycle slips could cause burst jamming signals. Usually reconnaissance, LOS clearing, and planning can eliminate many sources of cycle slips.

Differencing

Differencing is a method used by the processors to solve for the first estimation of a baseline solution and remove measurement errors.

Single Differences

A single difference can be formed by differencing the measurements acquired by two receivers observing the same satellite at a particular point in time or epoch. Therefore, integer ambiguities associated with each receiver are combined. Single differences between receivers virtually remove all satellite-dependent errors such as satellite clock error, and to a large extent, orbit errors and atmospheric delays. See figure 9-14.

A single difference can be formed by differencing the measurements acquired by one receiver observing two satellites at a particular point in time or epoch. Single differences between satellites reduce most receiver dependent errors. See figure 9-15.

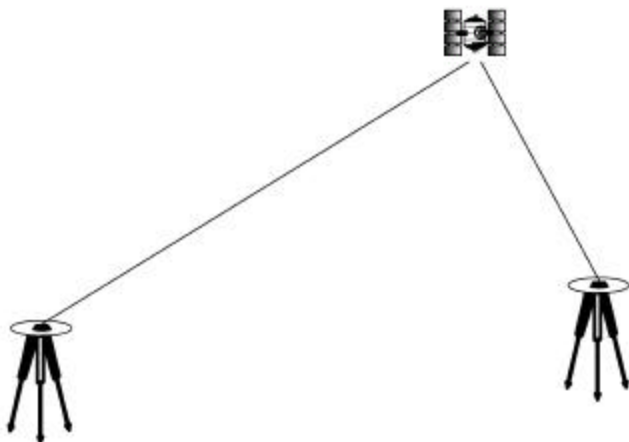

Figure 9-14. Single Differences between Receivers.

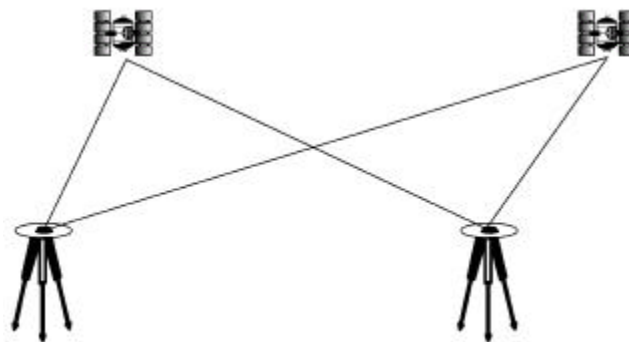

Figure 9-16. Double Differencing.



Figure 9-15. Single Differences between Satellites.

Double Differences between Satellites and Receivers

A double difference is formed by differencing two single differences. This involves two receivers observing the same two satellites at the same epoch. Four separate measurements and four separate integer ambiguities are combined to create a difference. The double differencing mode removes most of the effects of satellite and receiver clock drift. See figure 9-16.

Triple Differences between Satellites, Receivers, and Time

A triple difference is determined by combining two double differences over time. The double difference determined by a set of satellites and receivers at a particular epoch is combined with the double difference from the same satellites and receivers at a different epoch. In this mode, integer ambiguities cancel out of the computations because it does not change over time.

Triple differences are often used to find cycle slips. A cycle slip, in the single differencing mode, causes the receiver to recompute the combined integer; therefore after a cycle slip, the integer ambiguity does change. A large change in the triple difference is a good indicator of a cycle slip at that epoch. See figure 9-17.

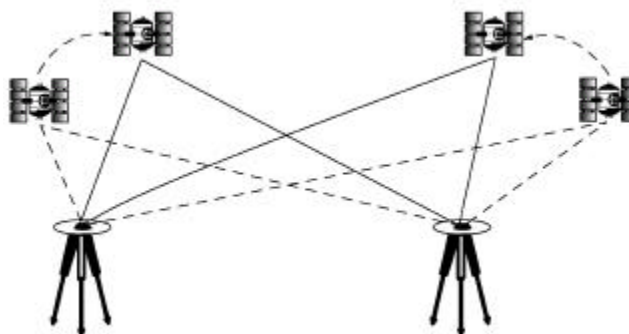

Figure 9-17. Triple Differencing.

Baseline Solutions (Vectors)

A baseline solution (vector) is a straight line defined by its 3-D (ΔX , ΔY , ΔZ) values when one end of the vector is the origin and the other end is the point containing those relative values. The processor uses the differencing methods described above along with code solutions to determine an initial estimate of the baseline vector. This initial estimate is called the triple difference solution.

If the integer ambiguity is known, multiply that value by the wavelength (19 centimeters – L1, 24 centimeters – L2) and add the partial wavelength to obtain the pseudo-range. At this point in the processing, the integer ambiguity is still an unknown value.

Float Solution

Once an initial estimate of the baseline vector has been determined, place that value in the formula—

$$\Delta X, \Delta Y, \Delta Z = (N \times \lambda) + \Delta\phi$$

Whereas: $\Delta X, \Delta Y, \Delta Z$ is the baseline vector,

N is the integer ambiguity,

λ is the integer wavelength,

$\Delta\phi$ is the phase change observed in a small portion of the data.

Often in processing, the value for N as determined in the above formula is not an integer. The ambiguity computes to a value such as 500.52. This value is not close enough to a whole integer for the processor to determine if the ambiguity is 500 or 501. It cannot set the value to a whole integer.

The value determined is compared against the remaining observations to see how well it fits. If the residuals (errors) are within a certain tolerance, the processor generates a new baseline vector; i.e., the float solution.

Fixed Solution

A fixed solution is obtained when the processor determines a set of integer values for the ambiguity that is significantly better than the other values.

The processor rounds the ambiguity value determined above to whole numbers for each satellite, each time testing different combinations of whole wavelength values to compute a baseline.

Each time a new set of integers is used, an associated variance (square of the standard deviation) is generated. After all possible combinations of whole wavelengths have been tried, the processor selects the solution with the lowest variance (least error). This is the fixed solution or fixed-integer solution.

The ratio of the errors between the integers used for the last iteration (the last computation of whole integer values) can be determined as—

$$\text{Ratio} = \frac{(\text{integers giving next least}) \text{ Errors}}{(\text{integers giving least}) \text{ Errors}}$$

With a single frequency receiver, this is the best solution that can be determined. It is sometimes referred to as a double-difference fixed solution.

With a dual-frequency receiver, it is possible to combine carrier phase observables to create other fixed solutions. A wide lane carrier phase is generated when the processor differences the carrier phase observables ($L1 - L2$). The effective wavelength is 86.2 centimeters. This combination allows for easier resolution of the integer ambiguities so it is often used to solve long baselines. The narrowlane carrier phase is generated when the processor combines the carrier phase observables ($L1 + L2$). The effective wavelength of the narrow lane carrier phase is 10.7 centimeters. This combination is very effective for canceling out ionospheric errors. This baseline solution uses a combination of the L1 and L2 carrier phases to model and remove the effects of ionospheric interference on the signals. This is the optimal solution, used for high-order control networks and for observing long baselines.

SECTION IV. GPS SURVEY METHODS AND TECHNIQUES

Absolute Positioning

Absolute positioning is a GPS survey method that involves using a single passive receiver; e.g., AN/PSN-11 PLGR, AN/PSN-13 MSGR 4000. The term absolute does not refer to a specific accuracy. It means this method does not rely on any source of information other than what is collected by the receiver at that station. This position is not relative (common) to any other station. The accuracy of this position depends on many different error sources as well as the user's level of authorization (PPS or SPS).

The receiver collects data from multiple satellites and uses this data to determine position, velocity, and timing information. The position is generally determined from code phase measurements. Some receivers can use carrier phase measurements to determine absolute positions.

Differential (Relative) Positioning

Differential positioning requires at least two receivers collect data from at least four common satellites simultaneously to compute a vector between them. The vector is then fixed at one end to a point and the other end is the relative position.

Usually, one receiver is located at a known point. Depending on the differential technique used, more than four common satellites may be necessary. Processing the collected data can be performed in the office or by the receiver in the field, also depending on the differential technique used.

Much of the accuracy achieved from this method is due to the use of common satellites and common epochs (a specific point of time selected for a GPS measurement). Figure 9-16 shows that differential techniques negate most sources of error. This is because the same error exists at each station collecting data from a specific satellite at a specific epoch. The

errors broadcast by satellite PRN23 and collected by receiver A at epoch 1 are the same errors collected by receiver B at epoch 1. The errors broadcast from the satellites have no effect on the dimensions of the vector because the errors are equal at each end.

This is actually only true for errors sources in the Space and Control segments. User segment error sources are not always equal at each end of the vector. For distances under 25-30 kilometers, the tropospheric and ionospheric errors are basically the same. Signals from satellite PRN23 to receiver A travel through the same sampling of the atmosphere as the signals from PRN23 to receiver B. Larger distances may add some small errors into these measurements. An L1/L2 antenna will decrease this error.

Code Phase Differential Positioning

Determining differential positions from code phase measurements is performed by applying a correction to the pseudo-range determined from an individual satellite to the receiver.

This process begins with the pseudo-ranges from code phase measurements used to determine the absolute positions of the receivers. Since the errors collected at each receiver are the same for each epoch, a pseudo-range correction (PRC) can be computed. In other words, assume we know the exact position of a satellite at a specific epoch and the surveyed position of a GPS receiver, we can determine a true range. If the measured pseudo-range is 79 meters and the true range is 81 meters, the PRC is +2 meters. A pseudo-range correction can be generated for each satellite being observed. Any receiver that is simultaneously collecting data from at least four common satellites can apply the PRC to its pseudo-range measurements to obtain a relative (common) position; thus the distance between the two points will be relatively accurate (0.5-10 meters) even when the absolute positions are not.

Code phase differential positioning has its primary applications in real-time navigation where relative accuracy is as low as 10 meters are acceptable. Also,

some engineering survey applications can tolerate this accuracy. This would not be acceptable for geodetic applications, and does not meet artillery specifications.

Carrier Phase Differential Positioning

Determining differential positions from carrier measurement is as simple as fixing an end of a measured vector to determine the position of the other end. Through processing, other vectors can then be fixed to the end of the first vector to create a network. Kinematic and static surveys are both usually performed using carrier phase differential positioning.

Static and Kinematic Techniques

When GPS receivers are used for surveying purposes, it is generally accepted that the survey will be performed using carrier phase differential (relative) survey methods. Differential survey is usually divided into two techniques: static and kinematic.

Static surveys provide the most accurate results. Receivers must remain stationary (static) for a period of time depending on the type of static survey performed. There are two types of static survey: static and fast static. Both require extensive planning and post-processing. Static survey allows for extremely accurate networking of survey control. Due to planning, field work, and post-processing requirements, this technique should only be used by surveyors whose mission is to provide fourth order control.

Kinematic surveys provide accuracy results sufficient for most artillery survey missions (fourth and fifth order) but does not provide the same networking capabilities as static techniques. There are two types of kinematic surveys: stop-and-go and continuous. Stop-and-go surveys can be post-processed in the office computers or in the field by the receivers using RTK and RTK/OTF procedures. Kinematic survey techniques require that one receiver remains static while another acts as a rover, moving along a route or from station to station collecting data.

CHAPTER 10. HASTY SURVEY

If no known control exists, control may be assumed through the best available resources. Assuming control allows all units to start their mission immediately without waiting for survey teams to provide control. Once higher echelon control is available, conversion to common control procedures must be performed by all lower echelon units.

Hasty Position Determination Method

MSGR 4000 (AN/PSN-13) Absolute

An absolute position from the GPS-S MSGR 4000 is one source of assumed control. This will provide a sufficient position (10 meter CEP) and elevation. An azimuth must be determined by another means. Never use an azimuth computed between two absolute stations, even for assumed control.

PLGR (AN/PSN-11)

If no MSGR 4000 absolute points are available, the PLGR is the next best source of assumed control. Using the PLGR in the averaging mode will provide a sufficient absolute position (10 meter CEP) and elevation. An azimuth must be determined by another means. Never use an azimuth computed between two PLGR stations, even for assumed control.

Accuracy of positions determined by GPS absolute survey depends mostly on the amount of averaging time allowed. When properly set up and operated, the PLGR can provide data accurate to 10 meters CEP (averaging mode, FOM 1, 1 day-old almanac, and 300 averages obtained). These values assume the presence of a valid daily crypto key and correct datum selection.

Map Spot

A careful map inspection may determine assumed control. If possible, determine the azimuth from a source other than a map. All positions determined by

these hasty methods must be verified by a map spot to reduce the incidence of blunders

Map spot position accuracy depends on the scale of the map sheet and the abilities of the surveyor. In practice, a map spot position can be considered accurate to approximately 100 meters on a 1:50,000 scale map.

Hasty Azimuth Determination Method

Methods of assuming an azimuth are—

- Hasty astro.
- Simultaneous observation.
- Declinated aiming circle.
- Directional traverse.
- Scaled from a map.
- Compass; e.g., M2 or lensatic.

For any method above, the considered accuracy is ± 2 mils when determined with an M2A2 aiming circle. Azimuth accuracy of a directional traverse using an aiming circle is determined by multiplying the number of horizontal angles measured by 0.5 mils.

An azimuth determined by a declinated aiming circle (declination performed at a surveyed declination station) is considered accurate to ± 10 mils, not counting the effects of local magnetic attraction. If the declination was made from a map G-M angle, the accuracy is diminished by the age of the map's declination diagram information.

Azimuth accuracy determined by a compass (M2 or lensatic) depends on the accuracy of the type of grid to magnetic conversion used and local magnetic attraction (generally 10 to 20 mils).

Azimuth accuracy determined by scaling from a map depends on the accuracy of the plotted positions, map scale, and whether or not the map is generated from a conformal projection (in practice, 10 to 100 mils).

All azimuths determined by these hasty methods must be verified by a map spot to reduce the incidence of blunders. The preferred hasty method of determining azimuth is the one that provides the most accuracy for that particular situation.

Hasty Elevation Determination Method

A hasty elevation can be determined by absolute GPS methods, altimetric observations or by map spot. Elevation is the weakest component of a GPS absolute position. When a GPS elevation is determined, that elevation must be verified by map spot. A properly operated GPS can provide elevations accurate to ± 10 meters.

Altimetric elevation accuracy depends largely on the quality of the barometer in the altimeter. All altimetric

elevations must be verified by map spot. Contour lines on a NIMA topographic map (1:50,000 scale) are considered accurate to 1/2 contour interval 90 percent of the time. In other words, a map spot elevation should never be considered more accurate than 1 contour interval for that map sheet.

The M2A2 Aiming Circle

The M2A2 aiming circle is a small, lightweight instrument used in firing battery and artillery survey operations. In the firing battery, it is the instrument used for orienting (laying) howitzers and for performing hasty survey operations. In the artillery survey section, it is used primarily for target area surveys (intersection), checking surveyed azimuths, and for hasty survey operations. See figure 10-1.

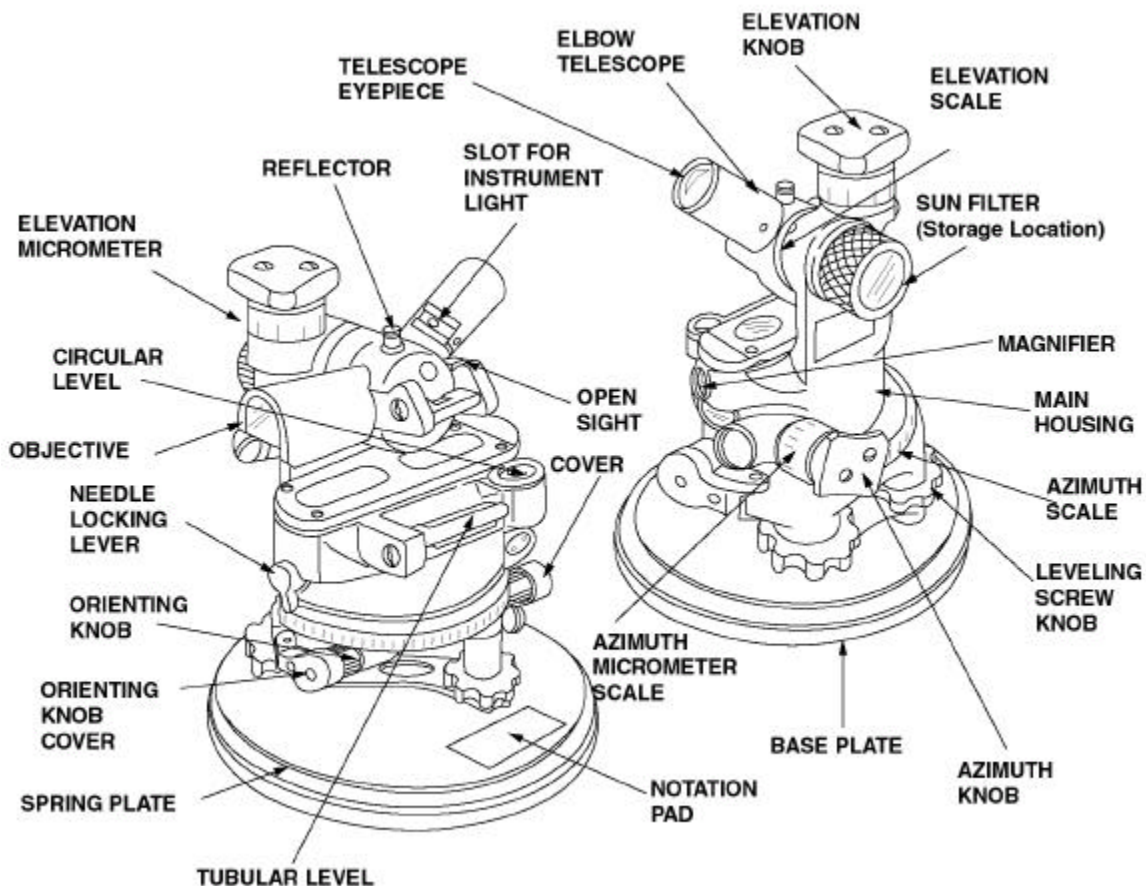

Figure 10-1. Aiming Circle M2A2.

The M2A2 consists of a four-power, fixed-focus, 10° field of view telescope mounted on a body that permits unlimited (6400 mils) horizontal angle measurements and vertical angle measurements from -400 mils to +1100 mils. The M2A2 weighs approximately 9 pounds. With its associated equipment, it weighs 21 pounds.

The rest of this chapter discusses the M2A2.

M2A2 Body

Telescope Assembly

The telescope assembly consists of the optical system, the vertical level vial, the reflector, the eyeshield, and the solar filter.

A four-power, fixed-focus telescope forms the optical system of the aiming circle. The telescope reticle is formed by a glass etched with a horizontal and vertical crosshair intersecting at the center of the field of view. Crosshairs are graduated every 5 mils from 0 to 85 from the center of the reticle. Graduations are numbered every 10 mils.

The Polaris 2 reticle is installed in most aiming circles. This includes the reticle pattern described above as well as three concentric circles used for aligning stars for the Polaris 2 method of astronomic observations. This method is no longer valid so the Polaris 2 portion of the reticle is not used. The telescope body is inclined 45° to allow the observer to stand erect and look down into the telescope.

The telescope level vial is located on the left side of the telescope. It establishes a horizontal plane along the telescope's line of sight. It is not used in artillery survey.

The reflector is a plastic signal post mounted on top of the telescope at the vertical axis of the instrument. The reflector is used as an aiming point for other instruments sighting on the aiming circle. It can be illuminated using the aiming circle's illumination kit.

The eye shield is a rubber shield that blocks light from entering your eyes from the side.

The solar filter mounts over the eyepiece end of the telescope when used for observations on the Sun. When not in use, store it on the filter post on the right side of the telescope above the serial number plate.

Body Assembly

The body assembly consists of the azimuth (horizontal) and elevation (vertical) worm mechanisms, the magnetic compass, the magnetic compass locking lever, and two horizontal plate levels.

The azimuth mechanism is generally referred to as recording motion or upper motion. Lateral movement of the azimuth micrometer knob allows for fast motion over the azimuth scale. Rotating the azimuth knob allows for slow motion. Two scales read a horizontal angle: the azimuth scale and the micrometer scale. The azimuth scale reads hundreds of mils. It is graduated in 100 mil intervals and numbered every 200 mils from 0-6400. The micrometer scale reads tens, ones, and half mils. It is graduated every whole mil and numbered every 10 mils through a 100 mil circle. The scale can be interpolated to 0.5 mils.

The elevation mechanism is generally referred to as the vertical motion. Rotating the elevation micrometer knob raises and lowers the telescope through its 1500 mil arc. Stop rings in the mechanism prevent the telescope from striking the body assembly when the telescope is depressed. Two scales are used to read a vertical angle: the elevation scale and the micrometer scale. The elevation scale reads hundreds of mils. It is graduated in 100 mil intervals and numbered every 100 mils from -400 to +1100 mils. Negative graduations are labeled in red, positive in black. The micrometer scale reads tens, ones, and half mils. It is graduated every whole mil and numbered every 10 mils through a 100 mil circle. Red numbers designate negative values, black numbers designate positive values. The scale can be interpolated to 0.5 mils.

The magnetic compass is located in the oblong recess in the top of the body assembly. The magnetic needle is limited in movement to approximately 11° arc and is provided with copper dampers to aid in settling the needle quickly. Two viewing windows are available to center the needle. The large window on the top of the body assembly is used for rough centering of the

needle. The second window is comprised of a small glass magnifier and a reticle with three etched lines at one end of the recess to aid in aligning the south end of the needle.

On the opposite end of the recess is the magnetic compass locking lever. When pointing down, the needle is locked in place; when rotated left or right, the needle is unlocked. The needle must always remain locked except when it is being used to prevent damage to the magnetic compass.

At the left side of the magnetic compass, are two horizontal plate levels: a circular level for rough leveling and a tube level fine leveling.

Worm Housing

The worm housing is the portion of the aiming circle between the horizontal azimuth scale and the base plate. It contains the worm gearing for the orienting motion and the leveling screws.

The orienting motion is generally referred to as the lower or nonrecording motion. Nonrecording motion is similar to the recording motion in that lateral movement of the orienting knob allows for fast motion. Rotating the knobs allows for slow motion. Nonrecording motion rotates the aiming circle around a vertical axis without changing values on the horizontal scales. Caps are provided to cover the orienting knobs when they are not being used. Each of the leveling screws are fitted into a threaded socket in the worm housing and attached to the base plate by means of a spring plate.

Base Plate Assembly

This assembly is the base of the instrument when it is mounted on a tripod. It also serves as the base of the carrying case. The instrument is attached to the base plate by means of the spring plate. The top of the base plate contains a rectangular notation pad for recording the declination constant and vertical angle correction. The bottom of the base plate assembly has a spring-loaded cap that covers a 5/8-inch threaded hole. This hole allows the instrument to be mounted on any tripod with a 5/8-inch fixing screw; i.e., GST-20 or M24. The base plate is fitted with a

rubber gasket that creates a watertight seal when the cover is properly attached.

Associated Equipment

Associated equipment includes the M24 tripod, the carrying case cover, and the accessory kit.

The M24 tripod has telescoping legs, an aluminum head and cover, and a carrying strap. Legs are adjusted for height and held in place by clamping screws. Hinges at the tripod head are adjusted for friction by clamping screws. The carrying strap holds the legs together in the retracted position and carries the tripod. The head cover is affixed to the tripod by a canvas strap.

The carrying case cover is a lightweight, dome-shaped, aluminum cover that clamps to the base plate assembly, creating a watertight seal.

The accessory kit consists of the backplate and cover, the instrument light, the plumb bob, and two lamp extractors. See figure 10-2. The backplate and canvas cover serve as the carrying case for the instrument light, plumb bob, and extractors. The backplate and cover attach to two clamps on one of the tripod legs. The instrument light provides artificial illumination to the instrument and the operator. It consists of a battery

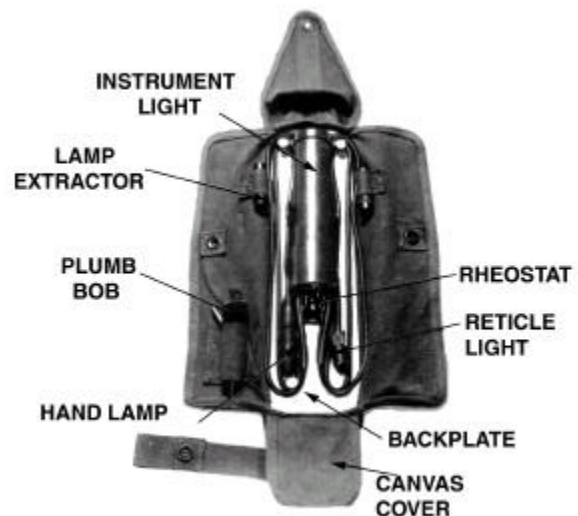

Figure 10-2. M2A2 Accessory Kit.

tube (two D cell), a rheostat knob, and two flexible cords. The rheostat knob adjusts light intensity. One of the cords provides illumination to the instrument through a lamp bracket that attaches to the machined slot on the top of the telescope assembly. The other cord is a penlight for the operator and recorder.

The plumb bob suspends from a hook attached to the fixing screw. It is rolled and stored in a loop in the canvas cover when not in use. The accessory kit contains two lamp extractors. They store extra lamps and remove bad bulbs from their sockets.

Setting Up The Tripod

The M24 tripod is the primary tripod used with M2A2 aiming circle. However, the instrument will mount on any tripod with a 5/8-inch fixing screw.

Upend the tripod, place the tripod head on the toe of your boot, and unbuckle the restraining strap. Loosen the leg clamp thumbscrews and extend the tripod legs to the desired length. Tighten the leg clamp thumbscrews sufficiently to maintain the weight of an instrument. Do not force the thumbscrews.

Spread the legs and place the tripod over the occupied station with one leg bisecting the angle to be measured. Set up the tripod head so that the telescope will be at a convenient height for the operator. Rough level the tripod.

Place the plumb bob loop over the hook at the fixing screw. The plumb bob should hang about 1 inch above the station. Center the tripod over the station to within approximately 1 inch of plumb.

Firmly embed the tripod legs in the ground. The plumb bob should now be within a 1/2 inch laterally of center of the station. The tripod head must approximate level once the legs are embedded in the ground.

Remove the tripod head cover. Leave the cover hang on the side of the tripod and lightly wipe your hand over the tripod head to remove any sand or dirt.

Attach the Aiming Circle to the Tripod

With the cover still on the instrument, open the spring loaded cover on the bottom of the base plate and thread the fixing screw into the socket until the aiming circle is firmly attached to the tripod. Unsnap the cover latches and remove the cover. Hang the cover on the leg clamp of the forward tripod leg.

Plumb and Level the Aiming Circle

Keeping one hand on the instrument, loosen the tripod fixing screw. Carefully slide the instrument over the tripod head until the plumb bob is centered exactly over the point.

Tighten the tripod fixing screw. Do not overtighten the fixing screw as this will bend the slotted arm and damage the tripod head.

Loosen the leveling screws to expose approximately 1/2 inch of threads. Rotate the instrument so that the level vial aligns with any two leveling screws. Grasp the leveling screw knobs between the thumb and forefinger of each hand. Turn the knobs simultaneously so the thumbs of both hands move toward each other or away from each other. (This movement tightens one screw as it loosens the other.) The bubble always moves in the same direction as the left thumb. Center the bubble by using these two leveling screw knobs. This is the first position.

Rotate the instrument clockwise 1600 mils. This second position places the axis of the tubular level at a right angle to the first position. Using the third leveling screw knob only, center the bubble.

Rotate the instrument clockwise 1600 mils so that it is 3200 mils from the first position. Level the instrument using the same two leveling screws as were used in the first position. This is the third position.

Rotate the instrument clockwise 1600 mils so that it is 3200 mils from the second position. Level the instrument using the same single leveling screw that was used in the second position, this is the fourth position.

Repeat the above steps until the bubble remains centered in both positions.

Rotate the instrument to the first position. If the bubble remains centered in this position, rotate the alidade to the second position. If the bubble remains centered in this position, rotate the alidade throughout 6,400 mils. If the bubble remains centered, the instrument is level.

If the bubble does not remain centered during the procedures in the previous paragraph but remains within one graduation, level the instrument by bringing the bubble halfway back towards the centered position.

Taking Down (March Ordering)

Tighten the leveling screws to their lowest point, then back them off 1/2 turn. Ensure the magnetic needle is locked, the level vials are covered, and the orienting knob covers are closed.

Place the azimuth knob over the notation pad. Set 0.0 mils on the vertical angle scale. Place the cover over the instrument and latch the cover locks. Roll the plumb bob and place it in the accessory case.

Keeping one hand on the instrument, unscrew the tripod fixing screw and remove the aiming circle from the tripod. Tighten the tripod cap onto the tripod head.

Keeping one hand on the tripod head, loosen the thumbscrews and collapse the tripod legs. Tighten the thumbscrews. Strap the legs together.

Measuring Horizontal and Vertical Angles

Horizontal angles are measured at the occupied station from the rear station to the forward station. When horizontal angles are made with the aiming circle, two repetitions of the angle are measured and the accumulative value is divided by 2 to determine the mean angle.

Step 1. Set up and level the aiming circle.

Step 2. Zero the azimuth and micrometer scales.

Step 3. Sight approximately on the rear station using the lower (nonrecording) fast motion.

Step 4. Using the lower slow motion, sight on the rear station with the vertical crossline. The last motion should be from left to right to reduce backlash due to play in the worm gear mechanism. Check to make sure the scales are still set to zero. Close the orienting knob covers.

Step 5. Using the upper (recording) fast motion, rotate the instrument near the forward station, to the left of the forward station.

Step 6. Using the upper slow motion, bring the crosshairs exactly on the station. Read the horizontal angle to the nearest 0.5 mils to the recorder.

Step 7. Sight the telescope to instrument height at the target using the vertical angle knob if vertical angles are required. Read the vertical angle to the nearest 0.5 mils to the recorder.

Step 8. With the horizontal angle on the azimuth scale, repeat steps 3 through 7. The horizontal angle measured this time will be an accumulative measure of two angles.

Recording and meaning a horizontal angle measured with an aiming circle is discussed on page 10-9.

Determining Vertical Angle Correction

To obtain correct measurements of vertical angles with the aiming circle, the horizontal axis of the telescope must lie in a true horizontal plane when the elevation scale is at zero. If it does not, a vertical angle correction must be determined and applied to each vertical angle measured. Two methods may be used to determine a vertical angle correction: the comparison method and the alternate set up method.

Comparison Method

The measured vertical angle is compared to a known vertical angle. This is normally performed at a declination station.

Step 1. After determining the declination constant, verify the level of the instrument. Measure and record the vertical angle to each azimuth mark to the nearest 0.5 mils, making sure that instrument height of the aiming circle is the aiming point at the azimuth marks.

Step 2. Verify the level of the instrument. Measure and record the vertical angles to each azimuth mark to the nearest 0.5 mils a second time.

Step 3. Determine the mean of the measured vertical angles to the nearest 0.1 mils. Determine the differences (\pm) between the mean measured vertical angles and the known vertical angles (Correction = Known Vertical Angle – Mean Measured Vertical Angle). If the differences agree within 1 mil of each other, determine the mean difference to the nearest 0.1 mil and record this value with the declination constant on the notation pad.

If the differences do not agree within 1 mil, repeat Steps 1-3 above.

Example: Using a declination station with two azimuth marks, determine the following values:

AzMk 1:	Kn Vert:	+23.0 mils
	Mn Meas Vert:	<u>+21.4 mils</u>
	Corr 1:	+1.6 mils

AzMk 2:	Kn Vert:	-9.0 mils
	Mn Meas Vert:	<u>-10.8 mils</u>
	Corr 2:	+1.8 mils

$$\begin{aligned} \text{Mn Corr} &= (\text{Corr 1} + \text{Corr 2})/2 \\ &= (1.6 + 1.8)/2 \\ &= +1.7 \end{aligned}$$

Alternate Set up Method

Two stations are set up approximately 100 meters apart and properly marked. It is not necessary to know the coordinates and elevation of the stations or the azimuth between the stations.

The aiming circle is set up and leveled over one of the stations (station A).

The instrument height is measured and marked on a range pole. The range pole is set up over the other station (station B).

Measure and record the vertical angle to the mark on the range pole to the nearest 0.5 mils.

The aiming circle is then moved to station B, set up and leveled.

The instrument height is measured and marked on the range pole. The range pole is set up over station A.

Measure and record the vertical angle to the mark on the range pole to the nearest 0.5 mils.

The vertical angles measured over the two lines are compared; if they are numerically equal, no vertical angle correction is necessary. If they are not equal, the vertical angle correction is determined as follows:

The correction is numerically equal to one half of the algebraic sum of the two vertical angles. In other words, add the angles together and then divide by two. Express the solution to the nearest 0.1 mils.

The sign of the correction is opposite the sign of the algebraic sum of the two vertical angles.

Example: If the first angle is +22.0 mils and the second angle is -24.0, the algebraic sum is -2.0 mils. The value of the correction is one half the sum or 1.0 mils. The sign of the correction is opposite the sign of the sum so the vertical angle correction is +1.0 mils.

UTM Grid Declination Constant

Three types of north are considered of importance to artillery surveyors: true, magnetic, and UTM grid. True north is the northerly direction of the meridian of longitude that includes your position. Magnetic north is the direction from your position to the North Pole of the Earth's magnetic field. UTM grid north is the northerly direction of a line that includes your position and is parallel to the central meridian of your UTM grid zone.

To determine grid north with an instrument equipped with a magnetic needle, the angular difference between UTM grid north and magnetic north must first be determined. The clockwise angle from UTM grid north to magnetic north is the UTM grid declination constant see figure 10-3. It may also be referred to as the UTM grid azimuth of magnetic north.

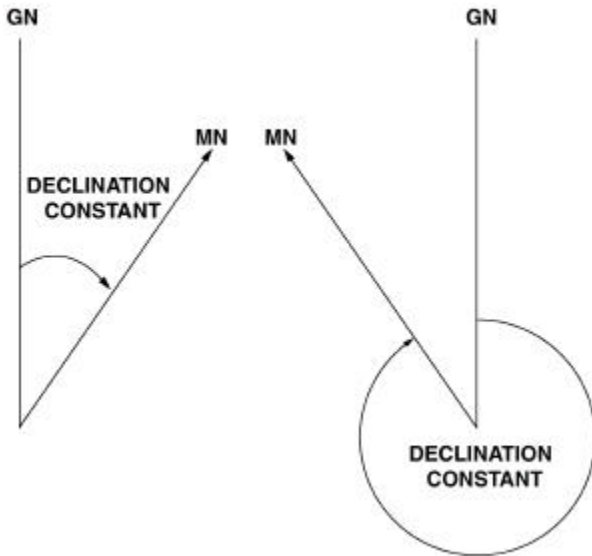

Figure 10-3. Angular Value Representing UTM Grid Declination.

When To Declinate An Aiming Circle (Required)

The following rules apply to the circumstances that indicate that declination of an aiming circle is *required*:

The aiming circle must be declinated after an electrical storm or after a severe shock such as falling from a vehicle. The magnetic needle is a delicately balanced mechanism and any shock can cause a significant change in the declination constant of the instrument.

The aiming circle should be declinated when moved more than 25 miles (40 kilometers) from the area in which it was last declinated. The change in the angle between magnetic north and UTM grid north is significant enough over 25 miles (40 kilometers) to

change the declination constant). The effects of local magnetic attraction may cause a change in the declination constant over a few hundred meters.

The aiming circle should be declinated at least every 30 days to minimize the effects of accidents that have occurred to the instrument and to factor in the changes in the Earth's magnetic field. The Earth's magnetic field has an annual change that can be calculated under standard conditions. The field is also affected by other forces such as sun spots and the Sun's and the Moon's gravity field.

If a radical change (± 2 mils) in the declination constant is observed after a monthly declination, the instrument should be redeclinated after a few days. This should ensure that the change was not caused by the temporary effects of a magnetic storm or sun spots.

When an aiming circle is returned from a maintenance facility or upon initial issue of an aiming circle, it must be declinated.

Batteries should check the declination of their aiming circles at each firing position established by battalion surveyors. This provides the battery with a valid declination should they move to a new location before the battalion surveyors have established known control.

Declination Stations

A declination station should be established at a location that is convenient to the using units. It may be established by any echelon of survey, regimental, battalion, or battery, as required by the situation. Declination stations within a battalion area of operations are the responsibility of the battalion survey section; however, for garrison training, most declination stations on Marine Corps installations are established by the regimental section.

Declination stations should have at least two (four if possible) well-defined azimuth marks with known azimuths in different quadrants, but one mark may suffice. Azimuth marks should be more than 1,000 meters from the declination station. This may not be possible in heavily wooded areas. An azimuth mark must never be less than 300 meters from the declination station.

Position and elevation of the declination station do not have to be of any specific accuracy. The position must be adequate to plot the station on a map and to locate the station. The azimuths to the azimuth marks should be at least fifth order. These azimuths can be determined by astronomic observations, RTK/OTF survey, the PADS, traverse, or by computations when coordinates of the declination station and azimuth marks are of sufficient accuracy to provide fifth order azimuths.

Establish the declination station in an area free of local magnetic attraction. The following minimum distances from common objects are prescribed:

- Power lines, 150 meters.
- Electronic equipment, 150 meters.
- Railroad tracks, 75 meters.
- Artillery, tanks, etc., 75 meters.
- Vehicles, 50 meters.
- Wire fences, 30 meters.
- Personal weapons, 10 meters.

Declining the M2A2 Aiming Circle at a Declination Station

Set up and level the aiming circle over the station.

Using the recording motion, set the known azimuth to the first azimuth mark on the azimuth scale. Using the non-recording motion, sight on the azimuth mark.

Using the recording fast motion, rotate the instrument towards north. Unlock the magnetic needle. Once the magnetic needle stops bouncing, center the magnetic needle with the recording motion while looking through the magnetic needle magnifier.

Once the magnetic needle is centered, lock the magnetic needle. Read and record the declination constant to the nearest 0.5 mils. Check the level of the aiming circle. Then repeat the above steps over the remaining azimuth marks.

Compare the values determined in the procedures above. If the spread between the largest and smallest reading is less than 2 mils, determine the mean declination constant to the nearest 0.5 mils by adding the individual readings together,

then dividing by the number of readings. If the values do not agree within 2 mils, repeat the entire process. Record the declination constant on the notation pad.

Converting a Grid Magnetic Angle to a Declination Constant

If a declination station is not available, the grid magnetic (GM) angle can be used to determine a declination constant. The GM angle is the angle, east or west, between UTM grid north and magnetic north. This method must be used only in the absence of a known azimuth and must be updated as soon as a known azimuth is available, even if that known azimuth is from hasty methods. Also, if the map declination diagram is more than 10 years old, the GM angle may be questionable due to annual change in the Earth's magnetic field.

A declination constant can easily be determined by simple math. If magnetic north is east of grid north, the declination constant is equal to the GM angle. If magnetic north is west of grid north, the declination constant is equal to 6400 mils minus the GM angle. See figure 10-4.

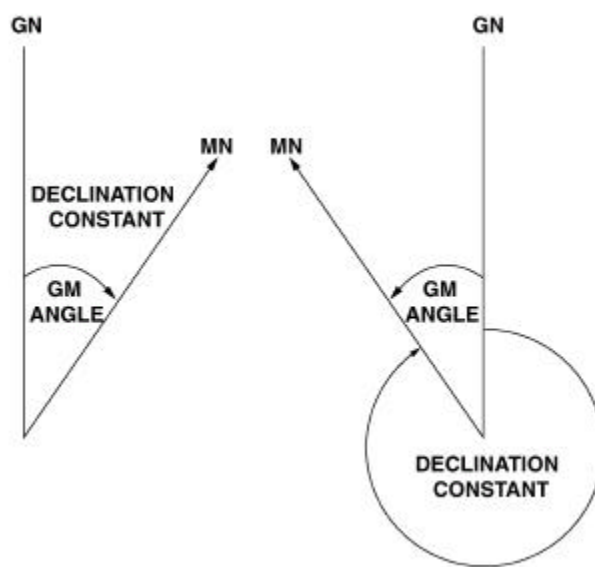

Figure 10-4. Relationship between a GM Angle and a Declination Constant.

Hasty Declination

When a declination station is not available and the map declination is questionable, select a point on the map that is easily identifiable on the ground. Set up and level the aiming circle over that point. Select two distant points that can be identified on the map and the ground. Scale the azimuth to the two points from the occupied station. Use the azimuths scaled from the map as if they were known azimuths.

Declinate the aiming circle as described on page 10-9. Compare the two values determined for the declination constant; they must agree within 10 mils. If they do, mean the values to determine the declination constant. If they do not, repeat the entire process. A declination constant determined in this manner must be verified at the first opportunity.

Determining A Grid Azimuth

A declinated aiming circle can be used to determine a grid azimuth. This is used in artillery survey mostly for verifying azimuths determined by other methods, but can also be used for determining azimuths to targets from an observation post without a surveyed azimuth mark.

Set up and level the aiming circle. Using the recording motion, set the declination constant on the azimuth scales.

With the non-recording fast motion, rotate the instrument towards north. Unlock the magnetic needle. Once the magnetic needle stops bouncing, center the needle using the non-recording slow motion while looking into the magnetic needle magnifier.

Lock the magnetic needle. Using the recording motion, sight on the forward station or target. Read and record the grid azimuth to the nearest 0.5 mils.

Orienting the M2A2 Aiming Circle on a Known Azimuth

An aiming circle can be oriented to a known azimuth and then used to determine a grid azimuth. This is used in artillery survey mostly for determining azimuths to targets from an observation post with a surveyed azimuth mark.

Set up and level the aiming circle over the station. Using the recording motion set the known azimuth on the azimuth scales. With the non-recording motion, sight on the azimuth mark. Using the recording motion, sight on the forward station or target. Read and record the grid azimuth to the nearest 0.5 mils.

Care of the Aiming Circle and its Associated Equipment

Proper care of an instrument will prolong its life and ensure its usability when needed. Care and maintenance of the aiming circle is discussed in detail in TM 9-1290-262-10.

The lenses should be cleaned with a camel hairbrush and lens paper. If a smudge will not come clean with the lens paper, moisten the paper with clean water, then wipe the lens with a lint free cloth. Care should be taken not to scratch the lens or to remove the bluish coating. The bluish coating reduces glare for the observer.

The tripod head should be wiped clean of dirt and moisture and should be examined for nicks or burrs before mounting the aiming circle. The screws and bolts must be kept snug. Loose screws can allow the tripod to twist slightly, causing measurement errors. Do not overtighten the bolts and screws to prevent stripping the threads.

Always ensure the magnetic needle is locked when not in use.

The instrument and its accessories must be kept clean and dry. Metal parts should be cleaned of grease and oil with mineral spirits and wiped dry. Care must be taken to insure that the threads of the leveling screws are clean and turn easily. Polished surfaces can be given a thin coat of light grade aircraft instrument lubricating oil to prevent rust. Electrical equipment can be cleaned with trichlorethylene. Canvas parts can be cleaned with soap, water, and a scrub brush, as can wood and metal parts not on the aiming circle itself.

The aiming circle should be stored in a dry ventilated area. Never store the aiming circle or its equipment while wet or damp. Allow the aiming circle to air dry with its cover off before storing.

Maintenance Checks and Adjustments

Five maintenance checks should be made. If any of these checks other than the micrometer knob check indicates an adjustment is necessary, turn the instrument into a maintenance facility.

Level Vial Check

After the aiming circle is set up and leveled, rotate the instrument through 6400 mils. If either the fisheye level or the vial level does not stay centered, turn the instrument in to a maintenance facility.

Tilted Reticle Check

After the aiming circle has been set up and leveled, place the vertical crosshair on a distant well defined point. Elevate and depress the telescope. If the vertical crosshair moves off the point as the telescope is elevated and depressed, return the instrument to a maintenance facility.

Azimuth and Elevation Micrometer Knob Adjustment

The only adjustment that may be made by the operator is the micrometer knob adjustment.

Set the zero of the scale opposite the index mark.

If the zero of the micrometer knob is opposite the index mark, no adjustment is necessary. If the zero is not opposite the index, loosen the screws on the end of the micrometer knob and slip the micrometer scale to align the zero and the index.

Hold the knob and the micrometer scale in position and tighten the micrometer screws. These screws strip easily, do not overtighten the screws.

Check to ensure both the zero on the scale and the zero on the micrometer are opposite their respective index marks.

Level Line Check

The level line check is the same procedure as the steps for determining the vertical angle correction. This check determines if the correct values are obtained when vertical angles are measured with the aiming circle. If correct vertical angles are not obtained and there is not enough time to turn the instrument in for repair, determine a vertical angle correction. This check must be made after the micrometer knob adjustment described above.

Magnetic Needle Check

Check the magnetic needle to ensure it does not stick and that it settles smoothly when centered in the needle magnifier. Once the instrument is set up and leveled, orient the telescope towards north. Release the magnetic needle and center it in the needle-magnifying window. Slowly move a piece of iron or steel back and forth in front of the instrument to move the needle to its pivot. Allow it to settle. If it does not settle centered in the window, turn it in to a maintenance facility. This test must be performed each time the instrument is declinated and should be performed each time the instrument is used to determine any values with the magnetic needle.

APPENDIX A. STAR CARDS

Constellation	Star Name and Number	Magnitude	Card
Andromeda	Alpheratz 1	2.1	9
Aquila	Altair 66	0.9	6
Aries	Hamal 11	2.2	7
Auriga	Capella 17	0.2	4
Bootes	Arcturus 51	0.2	2
Canis Major	Sirius 25	-1.6	5
	Adhara 26	1.6	5
	Wezen 27	2.0	5
Canis Minor	Procyon 29	0.5	5
Carina	Canopus 23	0.9	18
	Avior 32	1.7	18
	Miaplacidus 34	1.8	18
Cassiopeia	Schedar 5	2.3	17
	Caph 2	2.4	17
	Ruchbah 8	2.8	17
	Gamma Cassiopeia 7	1.6-2.8	17
Centaurus	Rigel Kentaurus 52	0.1	19
	Hadar 49	0.9	19
	Menkent 50	2.3	19
Cetus	Diphda 6	2.2	1
	Menkar 13	2.8	1
Corona Borealis	Alphecca 55	2.3	2
Corvus	Gienah 41	2.8	8
Crux (Southern Cross)	Acrux 42	1.0	19
	Mimosa 44	1.5	19
	Gacrux 43	1.6	19
	Deneb 68	1.3	6
Cygnus			
Draco	Eltanin 62	2.4	17
Eridanus	Achernar 9	0.6	12
	Acamar 12	3.4	12
Gemini	Pollux 30	1.2	4
	Castor 28	1.6	4
	Alhena 24	1.9	4
Grus	Al Nair 71	2.2	10
Hydra	Alphard 35	2.2	8
Hydrus	Beta Hydri 3	2.9	13
Leo	Regulus 36	1.3	14
	Denebola 39	2.2	14
Libra	Zebenelgenubi 53	2.9	15
Lyra	Vega 64	0.1	6
Octans	Nu 69	3.7	13
Ophiuchus	Rasalhague 61	2.1	15
	Sabik 59	2.6	15
Orion	Rigel 16	0.3	5
	Betelgeuse 22	0.1	5
	Bellatrix 18	1.7	5
	Alnilam 20	1.7	5
	Alnitak 21	2.0	5
Pavo	Peacock 67	2.1	11
Pegasus	Enif 70	2.5	9
	Markab 73	2.6	9
Perseus	Mirfak 14	1.9	7
Phoenix	Ankaa 4	2.4	10,12
Piscis Austrinus	Fomalhaut 72	1.3	10
Sagittarius	Kaus Australis 63	1.9	3
	Nunki 65	2.1	3
Scorpius	Antares 57	1.2	3,15
	Scaula 60	1.7	3
	Dschubba 56	2.5	3,15

Constellation	Star Name and Number	Magnitude	Card
Taurus	Aldebaran 15	1.1	4,7
	El Nath 19	1.8	4
Triangulum Australe	Atria 58	1.9	13
Ursa Major	Alioth 45	1.7	16
	Alkaid 48	1.9	16
	Dubhe 38	1.9	16
	Mizar 46	2.4	16
	Merak 37	2.4	16
	Phecda 40	2.5	16
Ursa Minor	Polaris 10	2.1	16,17
	Kochab 54	2.2	16,17
Vela	Gamma Velorum 31	1.9	18
	Suhail 33	2.2	18
Virgo	Spica 47	1.2	14

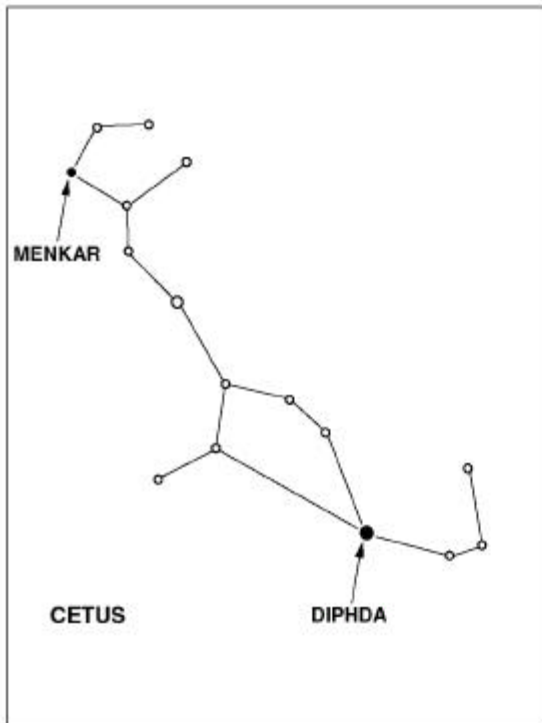

CARD 1

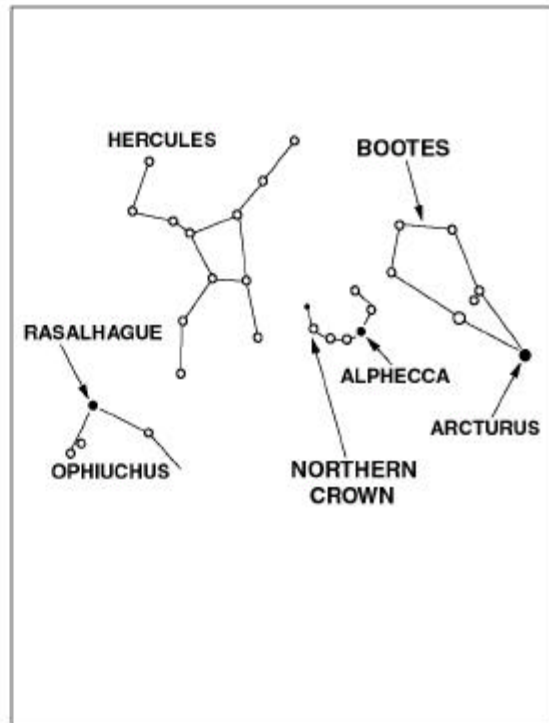

CARD 2

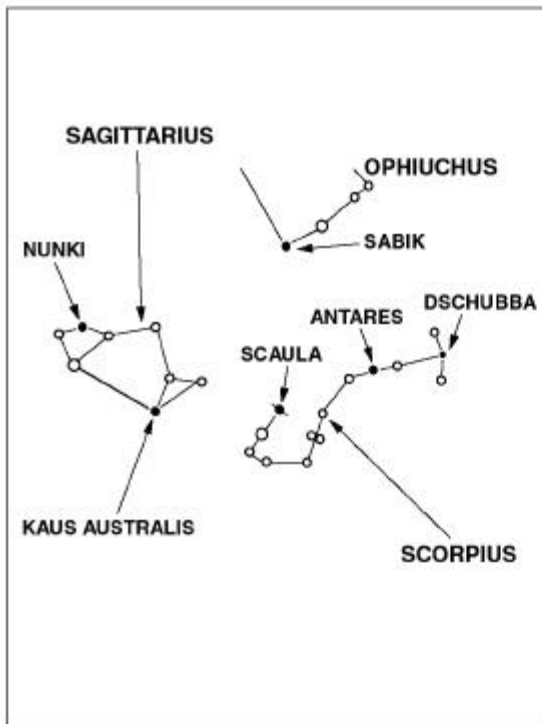

CARD 3

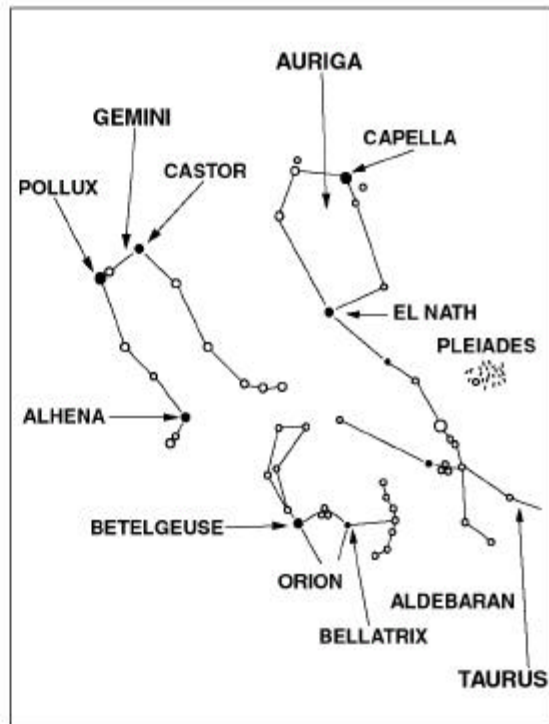

CARD 4

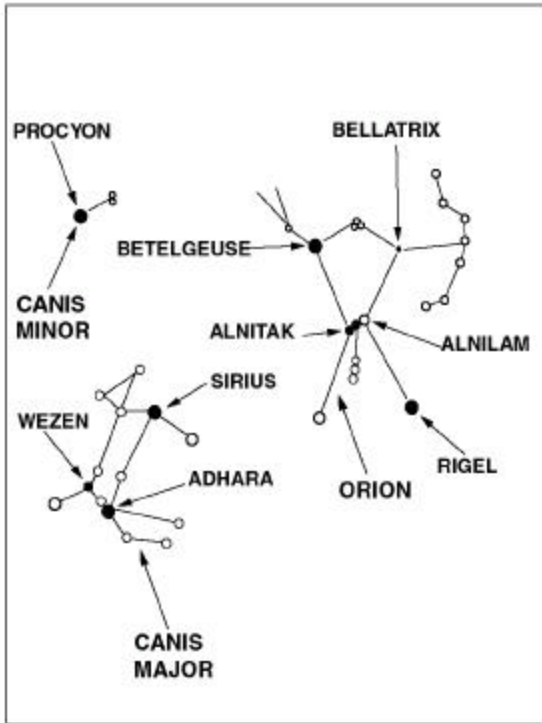

CARD 5

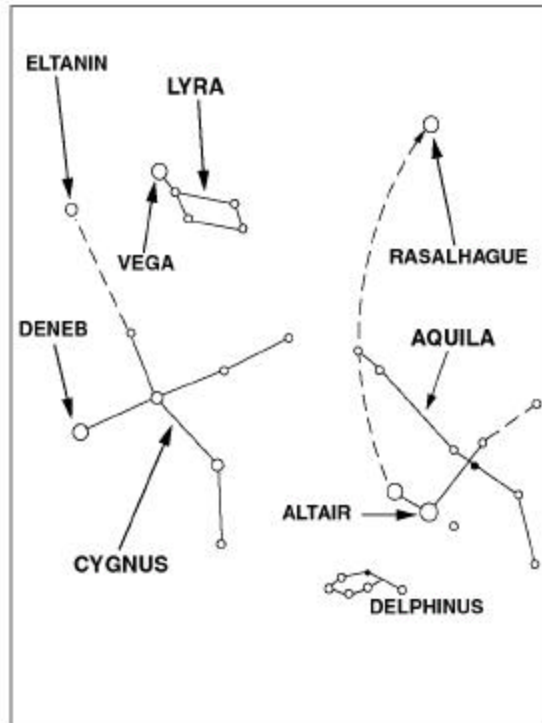

CARD 6

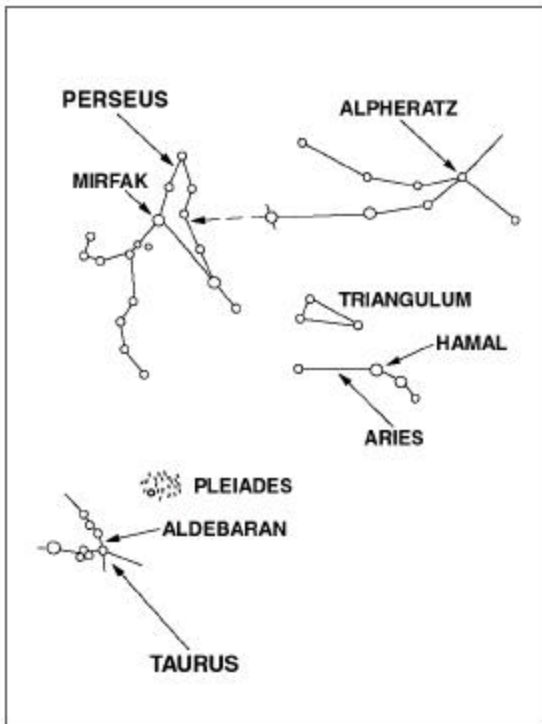

CARD 7

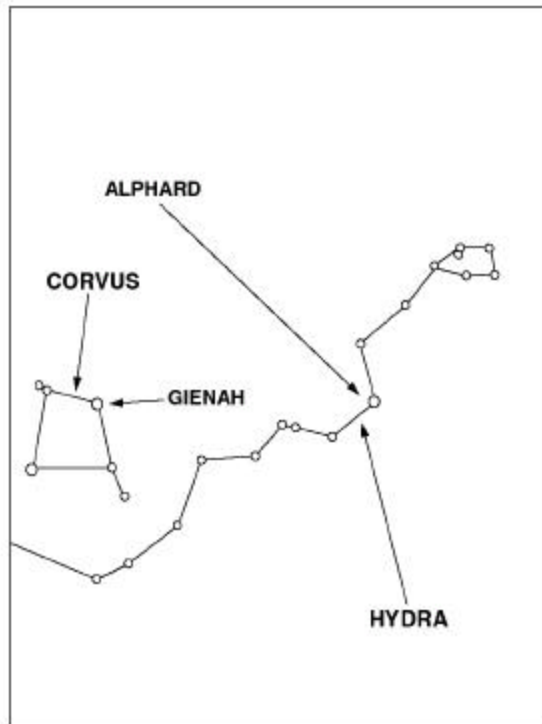

CARD 8

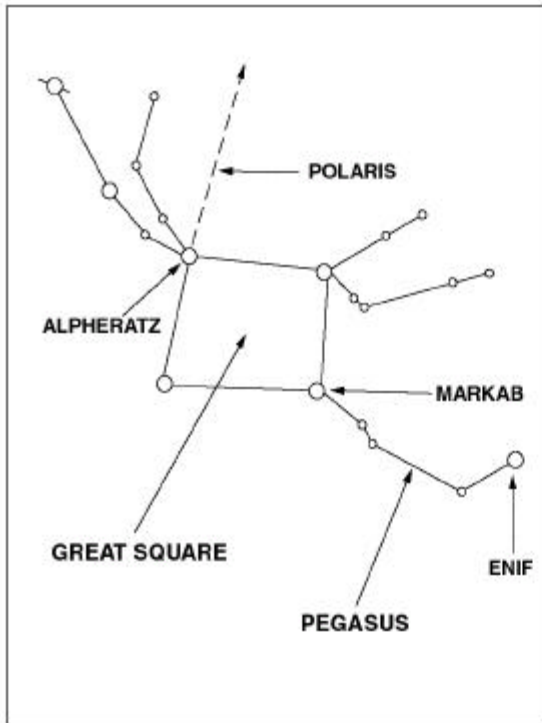

CARD 9

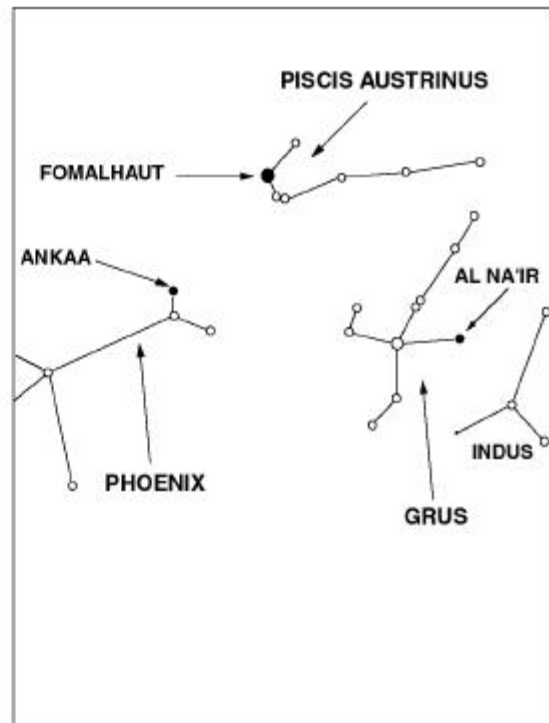

CARD 10

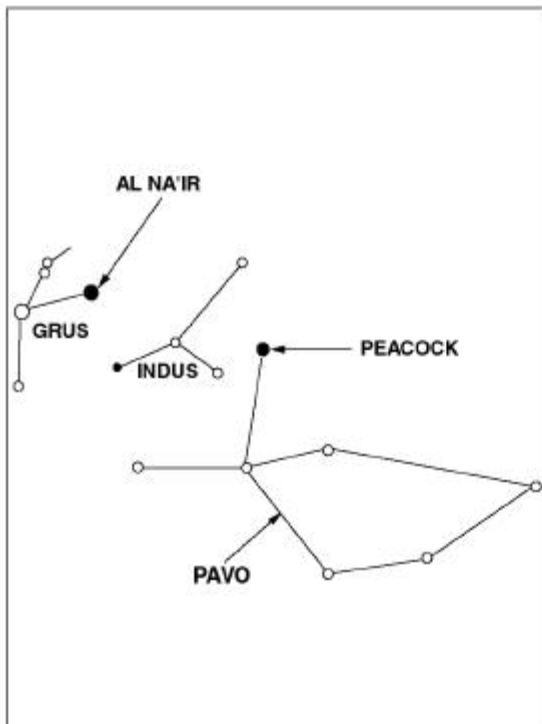

CARD 11

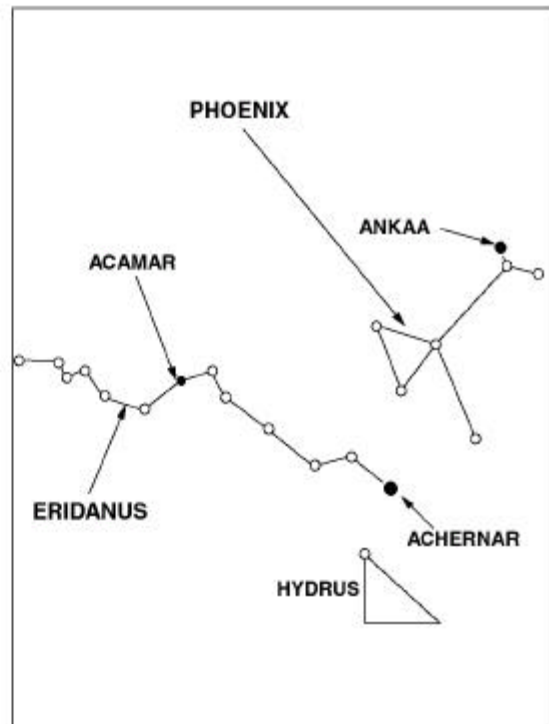

CARD 12

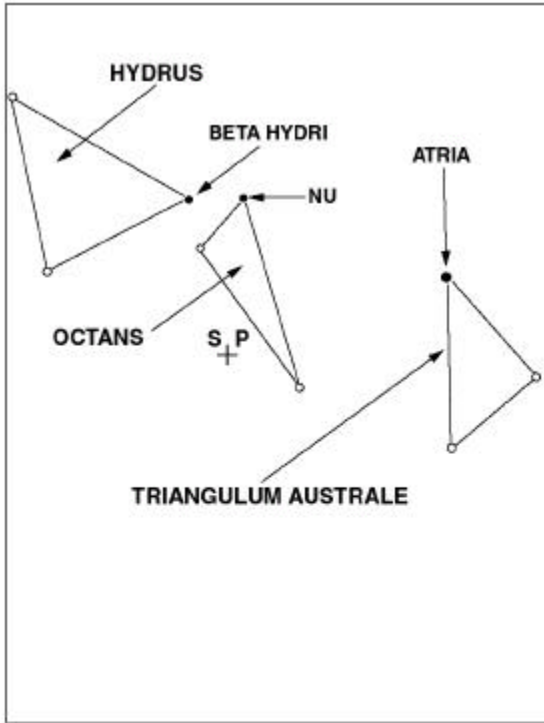

CARD 13

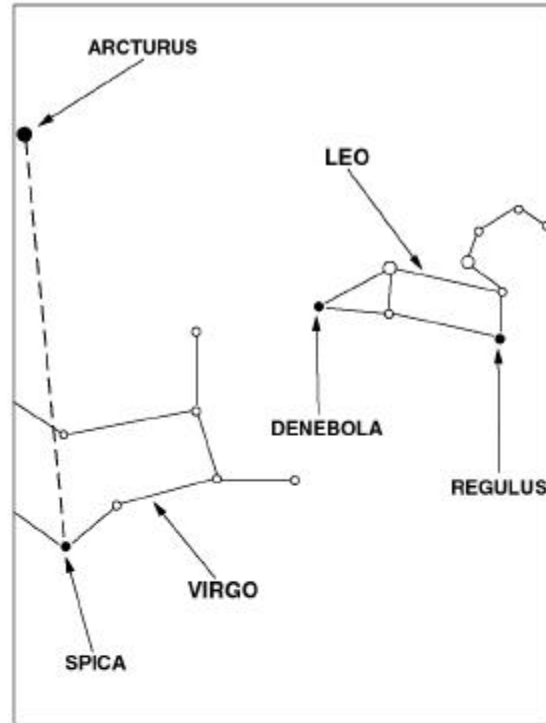

CARD 14

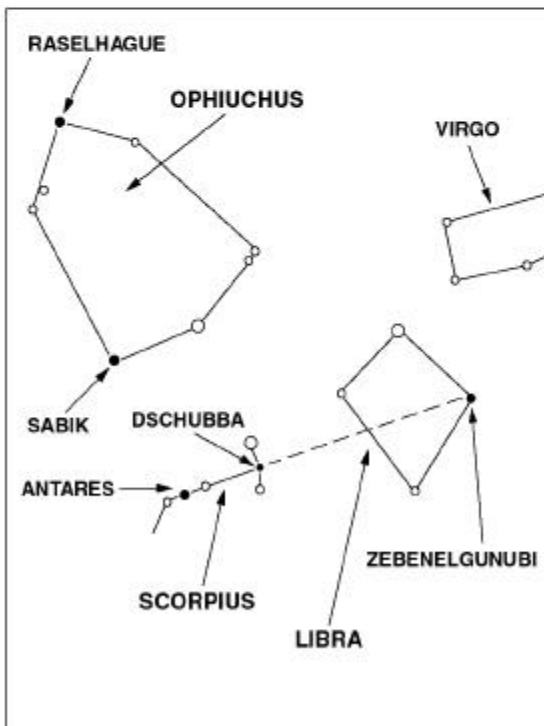

CARD 15

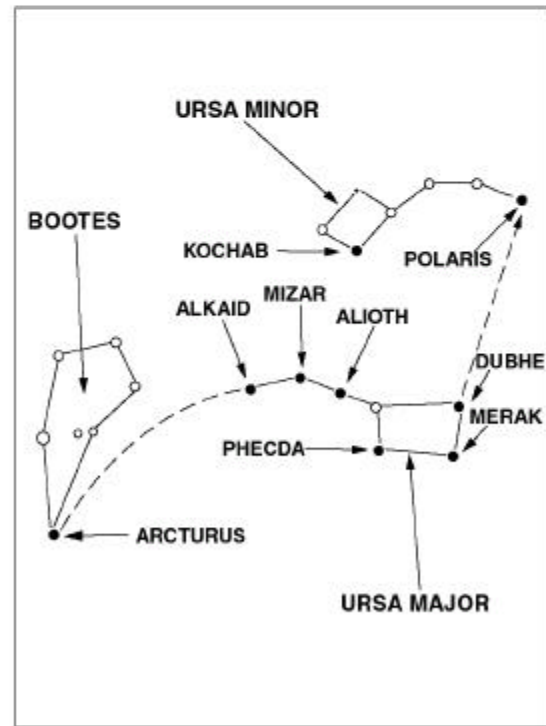

CARD 16

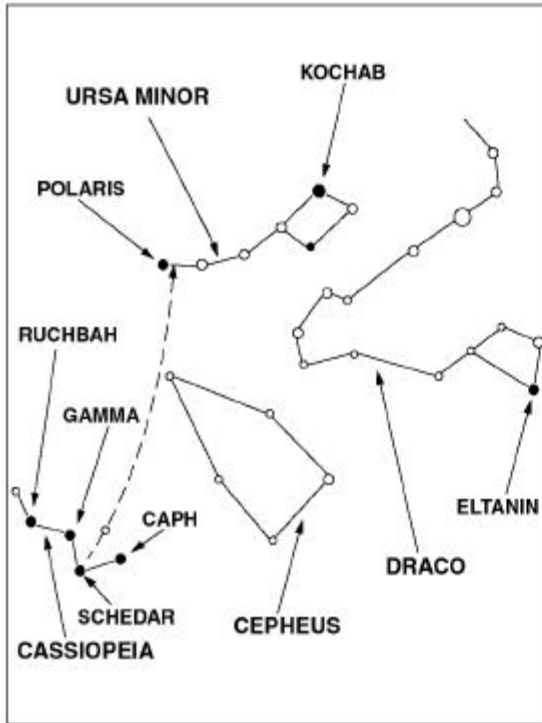

CARD 17

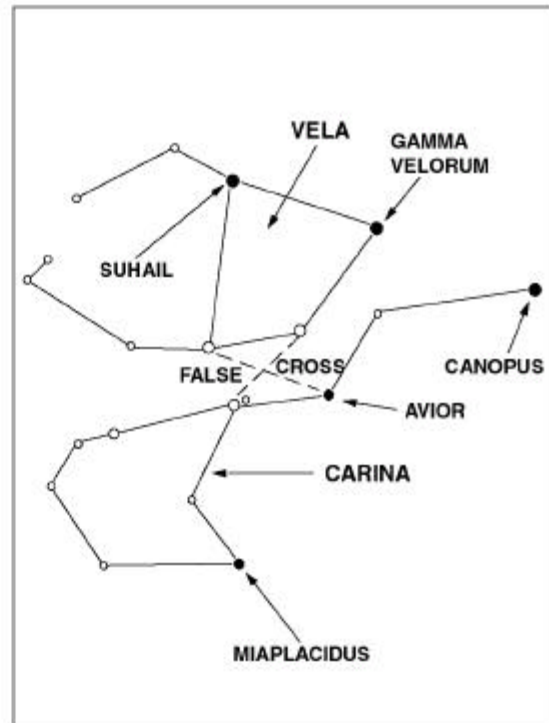

CARD 18

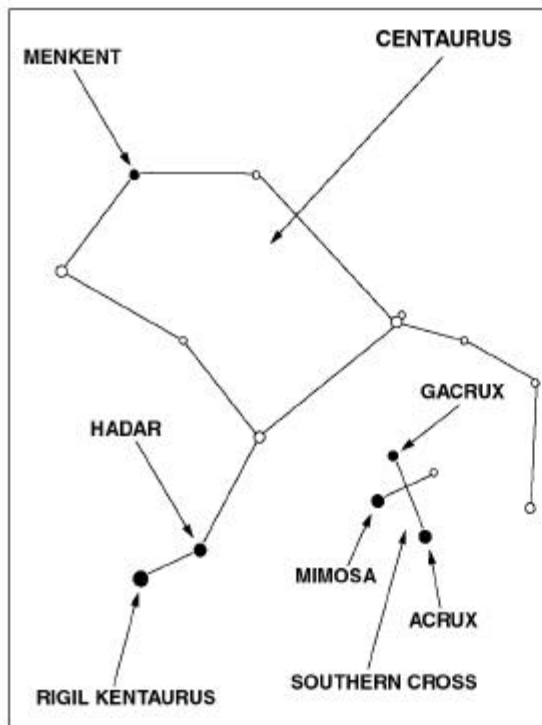

CARD 19

APPENDIX B. WORLD TIME ZONE OFFSETS

For selected countries listed alphabetically, the local standard time offset from Greenwich (UTC) is given with daylight savings time where observed. These offsets can be used to convert a UTC time to a local time; i.e., PLGR needs the offset to display local time. To determine Greenwich Mean Time from local time, a time zone correction is needed. Determine time zone corrections by changing the sign of the offset.

Country	Local Standard Time Offset
Afganistan	+4.5 hours
Albania	1 hour (Local summer +2 hours)
Algeria	+1 hour (Local summer+2 hours)
American Samoa	-11 hour
Andorra	+1 hour (Local summer+2 hours)
Angola	+1 hour
Anguilla	-4 hours
Antarctica	-2 hours (Local summer) -3 hours
Antigua	-4 hours
Argentina	-3 hours
Argentina Western Providence	-4 hours
Armenia	+4 hours (Local summer +5 hours)
Aruba	-4 hours
Ascension Island	0 hours
Australia Northern Territory	+9.5 hours
Australia Lord Howe Island	+10.5 hours (Local summer +11 hours)
Australia New South Wales	+10 hours (Local summer +11 hours)
Australia Queensland	+10 hours
Australia Victoria	+10 hours (Local summer +11 hours)
Australia Australian Captial Territory	+10 hours (Local summer +11 hours)
Australia South	+9.5 hours (Local summer +10.5 hours)
Australia Tasmania	+10 hours (Local summer +11 hours)
Australia Western	+8 hours
Austria	+1 hour (Local summer +2 hours)
Azerbaijan	+3 hours
Azores	-1 hour (Local summer 0 hours)
Bahamas	-5 hours (Local summer -4 hours)
Bahrain	+3 hours
Balearic Islands	+1 hour (Local summer +2 hours)
Bangladesh	+6 hours
Barbados	-4 hours
Belarus	+2 hours (Local summer +3 hours)
Belgium	+1hour (Local summer+2 hours)
Belize	-6 hours
Benin	+1 hour
Bermuda	-4 hours (Local summer -3 hours)
Bhutan	+6 hours
Bolivia	4 hours (Local summer -3 hours)
Bonaire	-4 hours
Bosnia Herzegovian	+1 hour (Local summer +2 hours)
Botswana	+2 hours
Brazil Acre	-4 hours (Local summer -5 hours)
Brazil Atlantic Islands	-1 hour (Local summer -2 hours)
Brazil East	-3 hours (Local summer -1 hour)
Brazil West	-4 hours (Local summer-3 hours)
British Virgin Islands	-4 hours
Brunei	+8 hours
Bulgaria	+2 hours (Local summer +3 hours)
Burkina Faso	0 hours
Burundi	+2 hours
Cambodia	+7 hours
Cameroon	+1 hours
Canada Central	-6 hours (Local summer -5 hours)
Canada Eastern	-5 hours (Local summer -4 hours)
Canada Mountain	-7 hours (Local summer -6 hours)
Canada Yukon and Pacific	-8 hours (Local summer-7 hours)
Canada Atlantic	-4 hours (Local summer-3 hours)
Canada Newfoundland	-3.5 hours (Local summer -2.5 hours)

Country	Local Standard Time Offset
Canary Islands	0 hours (Local summer +1 hour)
Canton Enderbury Islands	-11 hours
Cape Verde	-1 hour
Caroline Island	+11 hours
Cayman Islands	-5 hours
Central African Republic	+1 hour
Chad	+1 hour
Channel Islands	0 hours (Local summer +1 hour)
Chatham Islands	+12.75 hours (Local summer +13.75 hours)
Chile	-4 hours (Local summer -3 hours)
China People's Republic	+8 hours
Christmas Islands	-10 hours
Colombia	-5 hours
Congo	+1 hour
Cook Islands	-10 hours
Costa Rica	-6 hours
Cote d'Ivoire	0 hours
Croatia	+1 hour (Local summer +2 hours)
Cuba	-5 hours (Local summer-4 hours)
Curacao	-4 hours
Cyprus	+2 hours (Local summer +3 hours)
Czech Republic	+1 hour (Local summer +2 hours)
Dahomey	+1 hour
Denmark	+1 hour (Local summer +2 hours)
Djibouti	+3 hours
Dominica	-4 hours
Dominican Republic	-4 hours
Easter Island	-6 hours (Local summer -5 hours)
Ecuador	-5 hours
Egypt	+2 hours (Local summer +3 hours)
El Salvador	-6 hours
England	0 hours (Local summer +1 hour)
Equitorial Guinea	+1 hour
Eritrea	+3 hours
Estonia	+2 hours (Local summer +3 hours)
Ethiopia	+3 hours
Falkland Islands	-4 hours (Local summer -3 hours)
Faroe Islands	0 hours (Local summer +1 hour) +1 hour
Fiji	+12 hours
Finland	+2 hours (Local summer +3 hours)
France	+1 hour (Local summer +2 hours)
French Guiana	-3 hours
French Polynesia	-10 hours
Gabon	+1 hour
Galapagos Islands	-5 hours
Gambia	0 hours
Gambier Island	-9 hours
Georgia	+4 hours
Germany	+1 hour (Local summer +2 hours)
Ghana	0 hours
Gibraltar	+1 hour (Local summer +2 hours)
Greece	+2 hours (Local summer +3 hours)
Greenland	-3 hours (Local summer -2 hours)
Greenland Thule	-4 hours (Local summer -3 hours)
Greenland Scoresbysund	-1 hour (Local summer 0 hours)
Grenada	-4 hours
Grenadines	-4 hours
Guadeloupe	-4 hours
Guam	+10 hours
Guatemala	-6 hours
Guinea	0 hours
Guinea Bissau	-1 hour (Local summer 0 hours)
Guyana	-3 hours
Haiti	-5 hours (Local summer -4 hours)
Hondurast	-6 hours
Hong Kong	+8 hours
Hungary	+1 hour (Local summer +2 hours)

Country	Local Standard Time Offset
Iceland	0 hours
India	+5.5 hours
Indonesia Central	+8 hours
Indonesia East	+9 hours
Indonesia West	+7 hours
Iran	+3.5 hours
Iraq	+3 hours (Local summer +4 hours)
Ireland, Republic of	0 hours (Local summer +1 hour)
Israel	+2 hours (Local summer +3 hours)
Italy	+1 hour (Local summer +2 hours)
Jamaica	-5 hours
Japan	+9 hours
Johnston Island	-10 hours
Jordan	+2 hours (Local summer +3 hours)
Kazakhstan	+6 hours (Local summer +7 hours)
Kenya	+3 hours
Kiribati	+12 hours
Korea, Dem Republic of	+9 hours
Korea, Republic of	+9 hours
Kusaie	+12 hours
Kuwait	+3 hours
Kwajalein	-12 hours
Kyrgyzstan	+5 hours (Local summer +6 hours)
Laos	+7 hours
Latvia	+2 hours (Local summer +3 hours)
Lebanon	+2 hours (Local summer +3 hours)
Leeward Islands	-4 hours
Lesotho	+2 hours
Liberia	0 hours
Libya	+2 hours
Lithuania	+2 hours (Local summer +3 hours)
Luxembourg	+1 hours (Local summer +2 hours)
Macedonia	+1 hour (Local summer +2 hours)
Madagascar	+3 hours
Madeira	0 hours (Local summer +1 hour)
Malawi	+2 hours
Malaysia	+8 hours
Maldives	+5 hours
Mali	0 hours
Mallorca Islands	+1 hour (Local summer +2 hours)
Malta	+1 hour (Local summer +2 hours)
Mariana Islands	+10 hours
Marquesas Islands	-9.5 hours
Marshall Islands	+12 hours
Martinique	-4 hours
Mauritania	0 hours
Mauritius	+4 hours
Mayotte	+3 hours
Melilla	+1 hour (Local summer +2 hours)
Mexico	-6 hours
Mexico Baja California Norte	-8 hours (Local summer -7 hours)
Mexico Nayarit	-7 hours
Mexico Sinaloa	-7 hours
Mexico Sonora	-7 hours
Midway Islands	-11 hours
Moldova	+2 hours (Local summer +3 hours)
Moldovan Rep Pridnestrovye	+2 hours (Local summer +3 hours)
Monaco	+1 hour (Local summer +2 hours)
Mongolia	+8 hours
Morocco	0 hours
Mozambique	+2 hours
Myanmarr	+6.5 hours
Namibia	+1 hour (Local summer +2 hours)
Nauru, Republic of	+12 hours
Nepal	+5.75 hours
Netherlands	+1 hour (Local summer +2 hours)
Netherlands Antilles	-4 hours
Nevis Montserrat	-4 hours

Country	Local Standard Time Offset
New Caledonia	+11 hours
New Hebrides	+11 hours
New Zealand	+12 hours (Local summer +13 hours)
Nicaragua	-6 hours (Local summer -5 hours)
Niger	+1 hour
Nigeria	+1 hour
Niue Island	-11 hours
Norfolk Island	+11.5 hours
Northern Ireland	0 hours (Local summer +1 hour)
Northern Mariana Islands	+10 hours
Norway	+1 hour (Local summer +2 hours)
Oman	+4 hours
Pakistan	+5 hours
Palau	+9 hours
Panama	-5 hours
Panama	+10 hours
Papua New Guinea	-4 hours (Local summer -3 hours)
Paraguay	-5 hours
Peru	+8 hours
Philippines	+12 hours
Pingelap	+1 hour (Local summer +2 hours)
Poland	+11 hours
Ponape Island	+1 hour (Local summer +2 hours)
Portugal	0 hours
Principe Island	-4 hours
Puerto Rico	+3 hours
Qatar	+4 hours
Reunion	+2 hours (Local summer +3 hours)
Romania	+2 hours (Local summer +3 hours)
Russian Federation zone one	+4 hours (Local summer +5 hours)
Russian Federation zone two	+4 hours (Local summer +5 hours)
Russian Federation zone three	+5 hours (Local summer +6 hours)
Russian Federation zone four	+6 hours (Local summer +7 hours)
Russian Federation zone five	+7 hours (Local summer +8 hours)
Russian Federation zone six	+8 hours (Local summer +9 hours)
Russian Federation zone seven	+9 hours (Local summer +10 hours)
Russian Federation zone eight	+10 hours (Local summer +11 hours)
Russian Federation zone nine	+11 hours (Local summer +12 hours)
Russian Federation zone ten	+12 hours (Local summer +13 hours)
Russian Federation zone eleven	+2 hours
Rwanda	-4 hours
Saba	-11 hours
Samoa	+1 hour (Local summer +2 hours)
San Marino	0 hours
Sao Tome and Principe	+3 hours
Saudi Arabia	0 hours (Local summer +1 hour)
Scotland	0 hour
Senegal	+4 hours
Seychelles	0 hours
Sierra Leone	+8 hours
Singapore	+1 hour (Local summer +2 hours)
Slovakia	+1 hour (Local summer +2 hours)
Slovenia	-10 hours
Society Islands	+11 hours
Solomon Islands	+3 hours
Somalia	+2 hours
South Africa	+1 hour (Local summer +2 hours)
Spain	+5.5 hours
Sri Lanka	-4 hours
St.Christopher	-4 hours
St. Croix	0 hours
St. Helena	-4 hours
St. John	-4 hours
St Kitts Nevis	-4 hours
St. Lucia	-4 hours
St Maarten	-3 hours (Local summer -2 hours)
St. Pierre and Miquelon	-4 hours
St. Thomas	-4 hours
St. Vincent	-4 hours

Country	Local Standard Time Offset
Sudan	+2 hours
Suriname	-3 hours
Swaziland	+2 hours
Sweden	+1 hour (Local summer +2 hours)
Switzerland	+1 hour (Local summer +2 hours)
Syria	+2 hours (Local summer +3 hours)
Tahiti	-10 hours
Taiwan	+8 hours
Tajikistan	+6 hours
Tanzania	+3 hours
Thailand	+7 hours
Togo	0 hours
Tonga	+13 hours
Trinidad and Tobago	-4 hours
Tuamotu Island	-10 hours
Tubuai Islands	-10 hours
Tunisia	1 hour
Turkey	+2 hours (Local summer +3 hours)
Turkmenistan	+5 hours
Turks and Caicos Islands	-5 hours (Local summer -4 hours)
Tuvalu	+12 hours
Uganda	+3 hours
Ukraine	+2 hours (Local summer +3 hours)
United Arab Emirates	+4 hours
United Kingdom	0 hours (Local summer +1 hour)
USA Central	-6 hours (Local summer -5 hours)
USA Eastern	-5 hours (Local summer -4 hours)
USA Mountain	-7 hours (Local summer -6 hours)
USA Arizona	-7 hours
USA Indiana East	-5 hours
USA Pacific	-8 hours (Local summer -7 hours)
USA Alaska	-9 hours (Local summer -8 hours)
USA Aleutian	-10 hours
USA Hawaii	-10 hours
Uruguay	-3 hours
Uzbekistan	+5 hours
Vanuatu	-+11 hours (Local summer +12 hours)
Vatican City	+1 hour (Local summer +2 hours)
Venezuela	-4 hours
Vietnam	+7 hours
Virgin Islands	-4 hours
Wake Island	+12 hours
Wales	0 hours (Local summer +1 hour)
Wallis and Futuna Islands	+12 hours
Windward Islands	-4 hours
Yemen	+3 hours
Yugoslavia	+1 hour (Local summer +2 hours)
Zaire Kasai	+2 hours
Zaire Kinshasa Mbandaka	+1 hour
Zaire Haut Zaire	+2 hours
Zaire Kivu	+2 hour
Zaire Shaba	+2 hours
Zambia	+2 hours
Zimbabwe	+2 hours

APPENDIX C. RADIO TRANSMITTING STATIONS FOR TIME SIGNALS

Call Sign	Location and Position	Frequency (MHz)
BPV	Shanghai, China N 31° 12' E 121° 26'	5.0 10.0 15.0
CHU	Ottawa, Canada N 45° 18' W 75° 45'	3.330 7.335 14.670
HBG	Prangins, Switzerland N 46° 24' E 06° 15'	0.075
JJY	Kogane, Tokyo, Japan N 35° 42' E 139° 31'	2.5 5.0 10.0 15.0
LOL1	Buenos Aires, Argentina S 34° 27' W 58° 21'	5.0 10.0 15.0
MSF	Rugby, United Kingdom N 52° 22' W 01° 11'	2.5 5.0 10.0
VNG	Lyndhurst, Australia S 38° 00' E 145° 02'	4.5 7.5 12.0
WWV	Fort Collins, Colorado, USA N 40° 41' W 105° 02'	2.5 5.0 10.0 15.0 20.0
WWVH	Maui, Hawaii, USA N 20° 46' W 156° 28'	2.5 5.0 10.0 15.0
ZUO	Olifantsfontein, South Africa S 25° 58' E 28° 04'	5.0
ZUO	Johannesburg, South Africa S 26° 11' E 28° 04'	10.0

APPENDIX D. CONVERSIONS

Angular Measurement

	Full Circle	3/4 Circle	Half Circle	1/4 Circle
Mils	6400	4800	3200	1600
Degrees	360	270	180	90
Grads	400	300	200	100
Radians	2π	$\frac{3\pi}{2}$	π	$\frac{\pi}{2}$

Decimal Degrees to Mils
 Decimal Degrees to Grads
 Decimal Degrees to Radians

Mils = Degrees/0.05625
 Grads = Degrees/0.9
 Radians = Degrees x (exact) $\frac{\pi}{180}$ (Pi)
 Rads = Degrees x 0.174532777

Mils to Decimal Degrees
 Mils to Grads
 Grads to Mils
 Grads to Decimal Degrees

Degrees = Mils x 0.05625
 Grads = Mils/16
 Mils = Grads x 16
 Degrees = Grads x 0.9

Radians to Decimal Degrees

Degrees = Rads x $\frac{180}{\pi}$ (Pi)

Mils to Degrees, Minutes, Seconds

Degrees, Minutes, Seconds to Mils

Step 1: Mils x 0.05625 = Decimal Degrees
 Step 2: 60 x Number to Right of Decimal = Decimal Minutes
 Step 3: 60 x Number to Right of Decimal = Seconds
 Example: Convert 2198.876 Mils

Step 1: (Minutes x 60) + Seconds = Number of Seconds
 Step 2: (Number of Seconds/3600) + Degrees = Decimal Degrees
 Step 3: Decimal Degrees/0.05625 = Mils
 Example: Convert 123° 41' 12.39"

Step 1: 2198.876 x 0.05625 = 123.686775°
 Step 2: 60 x 0.686775 = 41.2065'
 Step 3: 60 x 0.2065 = 12.39"
 2198.876 Mils = 123° 41' 12.39"

Step 1: (41' x 60) + 12.39" = 2472.39"
 Step 2: (2472.39"/3600) + 123° = 123.686775°
 Step 3: 123.686775/0.05625 = 2198.876 Mils
 123° 41' 12.39" = 2198.876 Mils

Vertical Angle (Mils)
 VA = Vertical Interval/Range in Km x 1.0186

Linear Measurement

From	To	Equation	
Meters	Feet (International)	$FT = M/0.3048$ exact	
	Feet (U.S. Survey)	$FT = M/0.30480060960$	
	Feet (British Ordnance)	$FT = M/0.304800756$	
	Feet (Indian old)	$FT = M/0.30479842$	
	Feet (Survey of India)	$FT = M/0.3047996$	
	Yards (International)	$YDS = M \times 1.093613$	
	Statute Miles	$SM_i = M/1609.344$ exact	
	Nautical Miles	$NM_i = M/1852$ exact	
	Feet (International)	Meters	$M = FT \times 0.348$ exact
		Nautical Miles	$NM_i = FT/6076.1033333$
Feet (U.S. Survey)	Meters	$M = FT \times 0.30480060960$	
	Meters	$M = FT \times 1200/3937$ exact	
	Statute Miles	$SM_i = FT/5280$ exact	
	Nautical Miles	$NM_i = FT/6076.1033333$	
Feet (Great Britain in Ordnance Survey)	Meters	$M = FT \times 0.304800756$	
*Feet (Indian Old)	Meters	$M = FT \times 0.30479842$	
Feet (Survey of India)	Meters	$M = FT \times 0.3047996$	
Statute Miles	Kilometers	$KM = M_i / 0.6213712$	
	Statute Miles	$M_i = KM \times 0.6213712$	

Celsius/Fahrenheit Measurement

$$^{\circ}F = 9 / 5 ^{\circ}C + 32$$

$$^{\circ}C = \frac{5(^{\circ}F - 32)}{9}$$

*Used by U.S. and Great Britain for surveys in India and border nations.

APPENDIX E. GLOSSARY

SECTION I. ACRONYMS AND ABBREVIATIONS

AR	accuracy ratio	DS	direct support
AS	antispoofing	DSP	display
AZMK	azimuth mark	DTD	data transfer device
BAMCIS	begin planning; arrange for reconnaissance; make reconnaissance; complete the plan; issue the order; supervise	ECEF	Earth-centered, Earth-fixed
BIH	Bureau International De l'Heure	eH	elevation error
BLM	Bureau of Land Management	EMP	electromagnetic pulse
BNG	British National Grid	EOL	end of the orienting line
bps	bits per second	EROMS	erasable read only memories
BUCS	backup computer system	FGCS	Federal Geodetic Control Sub-Committee
CA	comparative accuracy	FLOT	forward line of troops
C/A	coarse/acquisition	FO	forward observer
CDU	control and display unit	FOM	figure of merit
CE	circular error	FSCM	fire support coordinating measure
CEOI	communications-electronics operating instructions	FWD	forward
CEP	circular error probable	GDOP	geometric dilution of precision
COC	combat operations center	GEOREF	World Geographic Reference System
COE	US Army Corps of Engineers	GHA	Greenwich hour angle
CONUS	continental United States	GK	Gauss-Kruger
COP	chief of party	GLONASS	Global Navigation Satellite System
COS	cosine	GM	grid magnetic
CUCV	commercial utility cargo vehicle	GMT	Greenwich Mean Time
CVd	cryptovisible key	GN	grid north
CVW	cryptovisible weekly	GS	general support
CW	continuous wave	GS-R	general support-reinforcing
D	direct	GPS	global positioning system
2-D	two-dimensional	GPS-S	global positioning system-survey
3-D	three-dimensional	GRS	Geodetic Reference System
DA	Department of the Army	GUV	group unique variable
dE	difference easting	GZ	grid zone
dH	difference in elevation	HCS	handheld computer system
DI	rapid mode	HDOP	horizontal dilution of precision
DIL	repeat mode	HI	height of instrument
DIST	distance	HMMWV	high-mobility multipurpose wheeled vehicle
DMA	Defense Mapping Agency	HORZ	horizontal
dN	difference northing	HT	height of target
DOD	Department of Defense	IMU	inertial measurement unit
DOP	dilution of precision	INS	inertial navigation system
DOT	Department of Transportation	IO	instrument operator
		ITMG	Irish Transverse Mercator Grid

KEK..... key encryption key
 KPK..... key production key
 L1..... link 1
 L2..... link 2
 L1/L2..... dual frequency receiver
 LAT..... local apparent time
 LED..... light emitting diodes
 LMT..... local mean time
 LST..... local sidereal time

 MAGTF..... Marine air-ground task force
 MBS..... milibars of mercury
 MC&G AAR..... mapping, charting, and geodesy
 after action report
 MEDEVAC..... medical evacuation
 MEF-FWD..... Marine expeditionary force forward
 METT-T..... mission, enemy, terrain and weather,
 troops and support available-time available
 MG..... Madagascar Grid
 MGRS..... Military Grid Reference System
 MLRS..... multiple launch rocket system
 MMS..... meteorological measuring system
 MN..... mean
 MPF..... maritime prepositioning force
 MRE..... multiple regression equation
 ms..... microsecond
 MSL..... mean sea level
 MSGR..... military survey grade receiver 4000

 NAD..... North American datum
 NAVD..... North American vertical datum
 NAV Data..... navigation data
 NAVSTAR..... navigation, satellite, timing and
 ranging
 NGRS..... National Geodetic Reference System
 NGS..... National Geodetic Survey
 NGVD..... National Geodetic vertical datum
 NIMA..... National Imagery and Mapping Agency
 NOAA..... National Oceanic and Atmospheric
 Administration
 NOS..... National Ocean Survey
 NZMG..... New Zealand Map Grid

 OCC..... occupied
 OP..... observation post
 OS..... orienting station
 OTF..... on the fly

 P..... precise
 PADS..... Position and Azimuth Determining
 System
 PDOP..... position dilution of precision
 PE..... probable error
 PLGR..... precision, lightweight, GPS, receiver

PMCS..... preventive maintenance checks
 and services
 POL..... petroleum, oil, and lubricants
 PPM..... parts per million
 PPS..... precise positioning service
 PPS..... pulse per second
 PRC..... pseudo-range correction
 PRN..... pseudo-random noise

 QSTAG..... quadripartite standing
 agreement

 R..... reverse
 RA..... right ascension
 RAMS..... random access memories
 RCDR..... recorder
 RDF..... radio directional finder
 RDOP..... relative dilution of precision
 RE..... radial error
 READ..... reading
 RF..... radio frequency
 RMS..... root-mean-square
 RP..... registration point
 RPV..... remotely piloted vehicle
 RSO..... Rectified Skew Orthomorphic
 RTK..... real time kinematic

 S..... standard
 S-2..... intelligence officer
 S-3..... operations officer
 SA..... selective availability
 SCP..... survey control point
 SDI..... Strategic Defense Initiative
 SEP..... spherical error probable
 SIC..... Survey Information Center
 SICP..... survey instrument calibration program
 SINCGARS..... single channel ground and airborne
 radio system
 SNR..... signal-to-noise ratio
 SOP..... standing operating procedure
 SPS..... standard positioning service
 STA..... station
 STANAG..... standardization agreement
 SV..... satellite vehicle

 T..... telescope
 TCU..... tracking control unit
 TDOP..... time dilution of precision
 TFOM..... time figure of merit
 TM..... transverse mercator
 T/O..... table of organization
 TTL..... total traverse length
 TZ..... time zone
 UAV..... unmanned aerial vehicle

UERE user equivalent range error
 UHF ultra-high frequency
 UPS universal polar stereographic
 USGS United States Geological Survey
 UT Universal Time (same as GMT)
 UTC Universal Time Coordinated
 UTM universal transverse mercator

VERT vertical
 VDOP vertical dilution of precision
 VLF very low frequency
 WGS World Geodetic System
 Z-Vels Zero-Velocity Corrections

SECTION II. DEFINITIONS

absolute positioning—The unique ability of a GPS receiver to produce positional values without the reference of another receiver.

accelerometer—A device which measures acceleration. The output is double integrated to determine a change in distance.

accumulative error—An error that occurs with the same sign, and often with similar magnitude, in a number of consecutive or otherwise related observations. An example is measuring a distance with an uncalibrated distomat (EDME); each distance measured will be consistently long or short. The total accumulated error will be equal to the error in one measurement multiplied by the total number of measurements. Repetition cannot reduce this error. Also called constant error or systematic error.

accuracy—(1) How close a measurement or a group of measurements are in relation to a standard or true value. (2) The degree of conformity with a standard, or the degree of perfection attained in a measurement. Accuracy relates to the quality of a result and is distinguished from precision which relates to the quality of the operation by which the result is obtained.

accuracy ratio—In artillery survey, it is the ratio between the radial error in closure and the total traverse length of a survey. It is usually expressed as a fraction with a numerator of 1.

adjusted value—A value of a quantity derived from observed data by some orderly process which eliminates discrepancies arising from errors in those observed data.

adjustment—The determination and application of corrections to observations for the purpose of reducing errors or removing internal inconsistencies in derived results. The term may refer to mathematical

procedures or to corrections applied to instruments used in making observations.

alidade—The part of a surveying instrument which consists of a sighting device with index and reading and recording accessories.

altitude—(1) The altitude of a celestial body is the arc of its vertical circle measured from the observer's horizon to the body, or it is the vertical angle at the observer's position between the horizon and the body. (2) The vertical distance between a point and a reference surface; usually the topography.

ambiguity—The unknown number of whole carrier wavelengths between a satellite and a receiver. Also called cycle ambiguity.

angle—The arc of a circle formed by the intersection of two lines at the center of the circle.

anti-spoofing—An encryption technique developed by the US Department of Defense (DOD) that denies access to the P-code to any unauthorized users.

anywhere fix—A receiver with the unique ability to calculate a position without being given an approximate location and/or time.

apogee—The point in the orbit of a satellite about the Earth that is the greatest distance from the center of the Earth.

arbitrary grid—Any reference system developed for use where no grid is available or practical, or where military security for the reference is desired.

astronomic position—A point on the Earth whose coordinates were determined as a result of observations of celestial bodies.

autoreflexion—A method of creating a line which is perpendicular to a reflective porro prism by projecting the image of a theodolite telescope onto the porro prism, then back to the telescope.

azimuth—The horizontal angle measured clockwise between a reference direction and the line to an observed or designated point.

azimuth, astronomic—The angle between the plane of the observer's meridian and the plane of the hour circle containing the observed body, measured in the plane of the horizon, preferably clockwise from north. An astronomic azimuth is not by definition a true azimuth.

azimuth, geodetic—The angle between the geodetic meridian and the tangent to the geodetic line at the observer, measured in the plane perpendicular to the ellipsoidal, normal of the observer, preferably clockwise from north. A geodetic azimuth can be referred to as a true azimuth.

azimuth, grid—The horizontal direction of any line measured clockwise from grid north.

azimuth magnetic—The horizontal direction of any line measured clockwise from magnetic north.

azimuth, plane—The angle measured in a clockwise direction between grid north and a line on a grid.

azimuth, true—The horizontal direction of any line measured clockwise from true north.

back azimuth— (1) In a plane rectangular coordinate system, like UTM grid, the back azimuth differs from an azimuth by 180° (3200 mils). The azimuth and back azimuth form a straight line. (2) In geodetic survey, the azimuth and back azimuth do not differ by 180° because of convergence of the meridians. If the azimuth of point B from point A is given on a reference ellipsoid, then the back azimuth is the azimuth of point A from point B.

bandwidth—A measure of the width of the frequency spectrum of a signal expressed in hertz.

baseline—The resultant three dimensional vector, V , between any two stations from which simultaneous GPS data have been collected and processed. Generally given in Earth-centered cartesian coordinates where: $V = \Delta x, \Delta y, \Delta z$.

bearing—The direction of a line as measured from the north-south axis (X-axis) of a two dimensional system.

bearing angle—The acute angle formed between the north-south axis (X-axis) of a two dimensional system and a line connecting the origin with a point. In artillery survey, it is the angle between the grid north-south line and the azimuth line to the forward station.

bleeding edge—The edge of a map or chart on which cartographic detail is extended to the edge of the sheet. The bleeding edge usually includes overlap of a portion of an adjoining sheet.

binary biphase modulation—Phase changes on a constant carrier frequency of either 0 or 180 degrees. The phase changes represent the binary digits 0 and 1 respectively. In other words, a phase change from the carrier of 0° is the binary digit 0 ; a phase change from the carrier of 180° is the binary digit 1 .

binary code—A system used in communications where selected strings of 0 's and 1 's are assigned definite meanings.

built-in test—Usually an internal check for proper functioning. Also called **BIT**.

built-in test equipment—Internal components of equipment designed to conduct built-in tests on the equipment. Also called **BITE**.

broadcast ephemeris—The ephemeris broadcast by the GPS satellites.

calibration—The act of determining certain specific measurements in an instrument or device by comparison with a standard, for use in correction or compensating for non-standard errors.

carrier—A high frequency radio wave having at least one characteristic (frequency, amplitude, or phase) which may be varied by modulation from an accepted value. In general, the carrier wavelength is much shorter than the wavelengths of the codes.

carrier frequency—The frequency of the unmodulated fundamental output of a radio transmitter.

carrier phase—The phase measurement of the carrier wave, converted from a percentage to millimeters.

cartesian coordinates—A coordinate system in which locations of points in space are expressed by

reference to three mutually perpendicular planes, called coordinate planes. The three planes intersect in three straight lines called coordinate axes. The system is referred to as geocentric Cartesian coordinates when it defines the position of a point with respect to the center of mass of the Earth. See X-axis, Y-axis, and Z-axis.

celestial coordinates—The coordinates used to locate a celestial body by various systems. The coordinates considered in artillery are declination and right ascension.

celestial equator—The great circle on the celestial sphere whose plane is perpendicular to the axis of rotation of the Earth.

celestial geodesy—The branch of geodesy which utilizes observations of near celestial bodies, including man-made satellites, to determine the size and shape of the Earth.

celestial horizon—That circle on the celestial sphere formed by the intersection of the celestial sphere and a plane through the center of the Earth and perpendicular to the zenith-nadir line.

celestial north and south poles—The points at which the prolonged polar axis of the Earth intersects the celestial sphere. The celestial North Pole is the “P” in the PZS triangle.

celestial sphere—An imaginary sphere of infinite radius concentric with the Earth, on which all celestial bodies except the Earth are imagined to be projected. Astronomic surveying establishes that the celestial sphere and all bodies on the sphere rotate around the Earth from east to west.

central meridian—(1) The line of longitude at the center of a map projection. Generally, the basis for constructing the projection. (2) The longitude of origin at the center of each six-degree zone of the UTM grid system. (3) The longitude of the center of a time zone.

channel—GPS receiver hardware and software which allows the receiver to track the signal from one satellite at one of the two carrier frequencies. An eight-channel dual frequency receiver actually tracks sixteen channels.

chip—The minimum transition time interval for individual bits of either a 0 or a 1 in a binary pulse code, usually transmitted in a pseudo-random sequence.

circular error—An accuracy figure representing the stated percentage of probability that any point expressed as a function of two linear components (e.g., horizontal position) will be within the given figure. Commonly used figures are **CEP** (50%), **CE 1** (39.35%), **CE** (90%).

circumpolar—Revolving about the elevated pole without setting. A celestial body is circumpolar when its polar distance is approximately equal to, or less than, the latitude of the observer.

clock bias—The difference between a clock’s indicated time and true Universal Time.

clockwise angle—The horizontal angle measured on a clockwise rotation scale. The alidade does not necessarily have to turn clockwise to measure a clockwise angle. For example, the horizontal scale of a T2-E will measure the same angle between two stations no matter what direction the alidade is turned.

colatitude—The complement of altitude, or 90° minus the altitude. The term has significance only when used in connection with altitude measured from the celestial horizon, when it is synonymous with zenith distance.

codeless receiver—An instrument that does not require knowledge of the P or C/A codes to perform measurements. This type of receiver does not record ephemeris data; consequently, before a baseline solution is computed, an ephemeris file must be obtained from another source.

code receiver—An instrument that does require knowledge of the P or C/A codes to complete its measurements. This type of receiver will record the broadcast ephemeris.

coincidence—(1) In the measurement of angles with a theodolite, the instant at which two diametrically opposed index marks on the circle are in perfect optical alignment and appear to form a continuous line across the dividing line of the circle. (2) A prismatic arrangement common to leveling instruments and older theodolites wherein one-half of opposite ends of the leveling bubble are brought into view in a single image. Coincidence is achieved when two halves of the bubble ends match.

colatitude—The side of the PZS triangle from the zenith to the pole. The complement of latitude, or 90° minus the latitude.

comparative accuracy—The ratio between the difference in two measurements and the mean of those measurements. It is used to describe the accuracy of distances and is usually expressed as a fraction with 1 as a numerator. Also called **CA**.

conformal map projection—A map projection on which the shape of any small area of the surface mapped is preserved unchanged, and all angles around any point are correctly represented. Also called an orthomorphic map projection.

conic map projection, secant—A map projection produced by projecting the geographic meridians and parallels of a reference ellipsoid onto a cone which is secant to the surface of the ellipsoid. The points of secancy are usually two parallels of latitude. Also called a conic map projection with two standard parallels. (An example is the Lambert Conformal Projection.)

conic map projection, tangent—A map projection produced by projecting the geographic meridians and parallels of a reference ellipsoid onto a cone that is tangent to the surface of the ellipsoid. The point of tangency is usually a parallel of latitude. Also called a conic map projection with one standard parallel.

contour—Imaginary lines in which all points on each line have the same elevation. Used to depict the terrain of the ground onto the flat surface of a map.

contour interval—The difference in elevation between two adjacent contour lines. This interval is usually listed below the bar graph in the marginal data of a map.

contour line—A line on a map in which all points on the line have the same elevation.

contour line, index—An index contour line is a line of equal elevation that is depicted on a map in a bold print to distinguish it from intermediate contour lines. These lines are normally depicted as every fifth line; therefore, the elevation difference between these lines is normally five times the contour interval.

contour line, intermediate—The contour lines drawn between index contour lines. The elevation difference between these lines is equal to the contour interval.

contour line, supplementary—A contour line drawn between two intermediate contour lines. These lines are usually a dashed line and indicate an elevation difference of one-half the contour interval.

control segment—One of three GPS segments. The control segment is made up of monitoring and control stations that ensure the accuracy of the GPS satellite orbits and operation of their atomic clocks. There are currently five stations in the control segment.

convergence—The angular difference between two meridians at the intersection of two lines that are tangent to the meridians at the same parallel of latitude. Usually called convergence of the meridians.

coordinates—Linear or angular quantities that designate the position of a point in a given frame of reference. This term is usually referenced to three dimensional positioning systems such as Cartesian coordinates or Geodetic coordinates. The term has also been used to describe the position of a point located on a two dimensional grid system such as UTM or UPS.

counterclockwise angle—A horizontal angle measured in a counterclockwise direction. Used for the measurement of deflection angles.

course/acquisition code—The standard GPS code, it is broadcast on the L-1 frequency and is not encrypted. This code is subject to selective availability, and is sometimes called the civilian access code or, the clear access code. Also called **C/A**.

curvature of earth— (1) The offset from the tangent to the curve as a result of the curvature of the Earth and refraction combined. (2) The divergence of a plane surface from the surface of the Earth.

cycle ambiguity—See Ambiguity.

cycle slip—A discontinuity in measured carrier beat phase resulting in a temporary loss of lock in the carrier tracking loop of a GPS receiver.

cylindrical map projection—A map projection produced by projecting the geographic meridians and parallels of a reference ellipsoid onto a cylinder, and then developing the cylinder into a plane. This projection can be either tangent to the ellipsoid, or secant to the ellipsoid depending on the purpose of the product.

datum—(1) Any numerical or geometrical quantity, or set of such quantities which may serve as a reference or base for other quantities. (2) A point, line,

or surface used as a reference, as in surveying, mapping, or geology.

datum, horizontal—Also called a geodetic datum. A horizontal datum is generally defined by at least five quantities relating to position, azimuth, gravity models, and a reference ellipsoid. It fixes a reference ellipsoid to a specific orientation with respect to the surface of the geoid.

datum point—Any reference point of known or assumed coordinates from which calculations or measurements may be taken.

datum transformation—The systematic elimination of discrepancies between adjoining or overlapping triangulation networks from different datums by moving the origins, rotating, and stretching the networks to fit together.

datum, vertical—A level surface to which elevations are referred, usually mean sea level. Sometimes referred to as an altitude datum.

D-code—See NAV data.

declination—(1) The angular distance from the celestial equator to a celestial body measured along the hour circle of the celestial body. Declination is positive when the body is north of the celestial equator and negative when south. Declination roughly corresponds to astronomic latitude on the Earth. (2) Often used as a shortened term for magnetic declination, although this use is technically incorrect.

declination, grid—The angular difference between magnetic north and grid north.

declination magnetic—The angular difference between magnetic and true north.

deflection of the vertical—The angular difference between the upward direction of the plumb line (the vertical), and the perpendicular (normal) to the reference ellipsoid. This difference seldom exceeds 30" except in mountainous areas.

differencing—A technique used in baseline processing to resolve the integer cycle ambiguity, and to reduce a number of error sources including oscillator variations and atmospheric and orbital modeling errors. This technique "differences" the measurement of the carrier beat phase across time, frequency, receivers, satellites, or any combination of

these. The three most utilized differencing techniques are described below:

Single difference between receivers is the instantaneous difference in the complete carrier beat phase measurements made at two receivers simultaneously tracking the same signal.

Double difference between receivers and satellites is found by differencing the single difference for one satellite with the single difference for another satellite where both single differences are from the same epoch.

Triple difference between receivers, between satellites, and between epochs (time) is the difference between a double difference at one epoch and the same double difference at the following epoch.

differential positioning—The determination of the position of a station relative to a reference station when GPS receivers at each station are simultaneously tracking the same signals.

dilution of precision—A measure of the geometric contribution to the uncertainty of a position fix. The more specific terms are given below. Also called **DOP**.

(1) **GDOP**—Geometric dilution of precision is the measurement accuracy in 3D position and time.

(2) **PDOP**—Position dilution of precision is the measurement accuracy in 3D position.

(3) **HDOP**—Horizontal dilution of precision is the measurement accuracy 2D horizontal position.

(4) **VDOP**—Vertical dilution of precision is the measurement accuracy as standard deviation of vertical height.

(5) **RDOP**—Relative dilution of precision is a measurement of the quality of baseline reductions.

distance—The spatial separation of two points, measured by the length of a line joining them.

distance angle—An angle in a triangle opposite a side used as a base in the solution of the triangle, or a side whose length is to be computed.

distance, horizontal—The distance measured on a horizontal plane. Horizontal distance refers primarily

to taped distances or to distances reduced to horizontal through computations.

distance, slope—A straight-line distance between two points of unequal elevation. A slope distance is usually derived by electronic means and must be reduced to horizontal distance for use in artillery survey computations.

doppler-aiding—A signal processing strategy that uses a measured Doppler shift to help the receiver smoothly track the GPS signal, allowing more precise velocity and position measurement.

doppler shift—The apparent change in frequency of a received signal due to the rate of change of the distance between the transmitter and receiver.

double difference—See differencing.

dynamic positioning—See kinematic positioning.

earth-centered ellipsoid—A reference ellipsoid whose geometric center coincides with the Earth's center of gravity and whose semi-minor axis coincides with the Earth's rotational axis.

earth-fixed coordinate system—Any coordinate system in which the axes are stationary with respect to the Earth.

easting—The eastward (left to right) reading of grid values. This term is used with two dimensional coordinate systems.

eccentricity—The ratio of the distance from the center of an ellipse to its focus on the semi-major axis.

ecliptic—The great circle formed by the intersection of the plane of the Earth's orbit around the sun and the celestial sphere.

elevation—Vertical distance from a datum, usually mean sea level, to a point on the Earth's surface. More exactly, it is the distance between a point on the Earth's surface and the geoid, measured on a line perpendicular to the geoid. Elevation should not be confused with altitude which refers to points above the Earth's surface. Elevation is sometimes referred to as orthometric height.

ellipsoid—A surface whose plane sections (cross sections) are all ellipses or circles, or the solid enclosed

by such a surface. The terms ellipsoid and spheroid are used interchangeably. See also reference ellipsoid.

ellipsoid height—The distance between a point on the Earth's surface and the reference ellipsoid, measured along a line which is perpendicular to the ellipsoid. The ellipsoid height is positive if the point is outside of the reference ellipsoid. Also called geodetic height.

ellipsoid of revolution—The surface generated by an ellipse rotating on one of its axes. Also called an ellipsoid of rotation.

epoch—A period of time or a date selected as a reference for a measurement.

equator—The great circle on the Earth midway between the poles and in a plane perpendicular to the Earth's axis of rotation. It is the line of zero latitude.

equatorial axis—The diameter of the Earth described between two points on the equator. Twice the semi-major axis of a reference ellipsoid.

equatorial plane—A plane which includes all the points located at the equator.

equipotential surface—A surface having the same potential of gravity at every point.

error—The difference between an observed or computed value of a quantity and the ideal or true value of that quantity. An error is generally classified as one of three types: a blunder which can be identified and corrected, a systematic error which must be compensated for, and a random error which cannot be identified or compensated for.

error of closure—(1) The amount by which a quantity obtained by a series of related measurements differs from the true or fixed value of the same quantity. (2) (azimuth) The amount by which two values of the same azimuth line, derived by different surveys or other means, fail to be equal. This is usually termed azimuth error. (3) (traverse) The amount by which the value of the position of a traverse station, as obtained by computation through a traverse, fails to agree with another value of the same station as determined by a different set of observations or procedures. Usually called radial error, it is also called traverse error, position error, or horizontal error. (4) (triangulation) The amount by which the sum of the three interior angles of a triangle differ from 180° (3200 mils). (5) (horizon) The amount by which the sum of two or

more adjacently measured horizontal angles around one point fails to equal 360° (6400 mils). Measurement of the last horizontal angle completes a circle and is called closing the horizon.

fast switching channel—A switching channel with a time sequence short enough to recover the integer part of the carrier beat phase. The switching time is generally between 2 to 5 ms.

fault indicator—On the PADS, an indicator that allows an equipment operator to see that the equipment is either functioning properly or malfunctioning.

flattening—The ratio of the difference between the equatorial and polar radii of the earth to its equatorial radius. Also called ellipticity.

frequency band—A range of frequencies in a region of the electromagnetic spectrum.

fundamental frequency—The GPS fundamental frequency, F , is 10.23 MHz. The carrier frequencies are:

$$L1 = 154 * F = 1575.42 \text{ MHz}$$

$$L2 = 120 * F = 1227.60 \text{ MHz}$$

gauss-kruger projection—The same as the transverse mercator projection with the cylinder of projection placed tangent to the reference ellipsoid.

GDOP— See DOP.

geocentric—Relative to the Earth or geoid as a center, measured from the center of the Earth.

geocentric coordinates—Coordinates that define the position of a point with respect to the center of the Earth or geoid. Geocentric coordinates can be either Cartesian (x, y, z) or spherical (geocentric latitude and longitude, and radial distance). Astronomic coordinates are geocentric.

geocentric geodetic coordinates—Geodetic coordinates referred to a geocentric reference ellipsoid.

geocentric latitude—The angle at the center of the Earth or geoid between the plane of the celestial equator and a line to a point on the surface of the Earth. An astronomic latitude is geocentric.

geocentric longitude—Same as geodetic longitude.

geodesy—The science which deals with the determination of the size and figure of the Earth. It also deals with determining the external gravitational field of the Earth, the internal structure of the Earth, and derives three dimensional positions for points above, at, and below the surface of the Earth.

geodetic control—A system of horizontal and/or vertical control stations that have been established and adjusted by geodetic methods and in which the size and shape of the Earth have been considered in position computations.

geodetic coordinates—The quantities of latitude, longitude, and ellipsoid height, which define the position of a point on the Earth's surface with respect to a reference ellipsoid.

geodetic height—See ellipsoid height.

geodetic latitude—The angle between the plane of the equator and the normal to the ellipsoid through the computation point.

geodetic longitude—The angle between the plane of the geodetic meridian and the plane of the prime meridian. A geodetic longitude can be measured by the angle at the pole of rotation of the reference ellipsoid between the local and initial meridians, or by the arc of the geodetic equator intercepted by those meridians.

geodetic meridian—A line on a reference ellipsoid which has the same geodetic longitude at every point.

geographic coordinates—Any coordinate system that relates positions on the Earth in terms of latitude and longitude. Both geodetic and astronomic coordinates are geographic coordinates.

geoid—The equipotential surface in the gravity field of the Earth which coincides with the undisturbed mean sea level extended continuously through the continents. The direction of gravity is perpendicular to the geoid at every point. The geoid is the surface of reference for astronomic observations and for geodetic leveling.

geoid separation—The distance between the geoid and the reference ellipsoid measured along a line that is perpendicular to the ellipsoid. The distance is positive if the geoid is outside (above) the ellipsoid. Also called geoid height or undulation of the geoid.

global positioning system time—The broadcast GPS time signals are synchronized with atomic clocks at the GPS Master Control Station. These clocks are in turn periodically synchronized with Coordinated Universal Time “leap seconds” to correct for the slowing of the Earth’s rotation with respect to the sun; GPS time is not. As of Oct 1995, GPS time equals UTC + 10 sec. The fundamental time scale for all Earth time keeping is the International Atomic Time (TAI). It is a continuous time scale not corrected by “leap seconds.” There is a constant offset of 10 seconds between GPS time and TAI such that GPS time = TAI + 10 seconds.

graticule—A network of lines representing the Earth’s parallels of latitude and meridians of longitude.

great circle—A great circle is a circle, the plane of which passes through the center of a sphere or ellipsoid.

Greenwich Mean Time—Mean solar time at the meridian of Greenwich, England, used as a basis for standard time throughout the world. Also called GMT.

Greenwich meridian—The meridian of longitude through Greenwich, England; serving as the reference for Greenwich time, in contrast with local meridians. It is accepted, almost universally, as the prime meridian or the origin of measuring longitude.

Greenwich Time—Time based upon the Greenwich meridian as reference, as contrasted with that based upon a local or zone meridian. Greenwich Time is referred to as Zulu Time.

grid—Two sets of parallel lines intersecting at right angles and forming squares. When oriented with a map projection, the grid is used to determine grid coordinates.

grid convergence—The angular difference between the meridian of a point located within a plane grid system (such as UTM grid) and a line which is parallel to the central meridian of that grid and passing through the point.

grid coordinates—Numbers and letters of a two dimensional coordinate system which designate a point on a gridded map, photograph, or chart.

grid coordinate system—A plane-rectangular coordinate system usually based on, and mathematically adjusted to, a map projection. Also called a grid reference system.

grid north—The northerly or zero direction of a grid oriented with a projection. Grid north in one grid system may not be the same direction as in another grid system.

grid zone—An arbitrary division of the Earth’s surface designated for identification without reference to latitude or longitude.

gyroscope—A spinning wheel which tends to keep a fixed orientation in space. Used to sense rotation.

gyrocompassing—A method used to find true north by sensing the Earth’s rotation.

handover word—The word in the GPS message that contains time synchronization information for the transfer from the C/A-code to the P-code.

HDOP—See DOP.

height—The vertical distance of an object or point above a reference plane.

height of instrument—The height of the center of the telescopic alidade above the ground or station mark.

horizon—The horizon for any place on the surface of the Earth is the great circle formed on the celestial sphere by the extension of the plane of the observer’s horizon. In general, the apparent or visible junction of Earth and sky as seen from any position.

horizontal angle—In artillery survey, the angle formed by the intersection of the line between the occupied station and rear station and the line between the occupied station and the forward. This angle is measured from the rear station to the forward station.

horizontal control—A network of stations of known geographic or grid positions referred to a common horizontal datum.

hour angle—The time elapsed since the upper transit of a celestial body. It is the angle between the observer’s meridian and the hour circle of the celestial body, measured positive westward from the meridian.

hour circle—Any great circle on the celestial sphere whose plane is perpendicular to the plane of the celestial equator.

instrument parallax—A change in the apparent position of an object with respect to the reference

marks of an instrument which is caused by imperfect adjustment of the instrument.

integer-cycle ambiguity—The unknown integer number of whole carrier cycles between the satellite and the receiver.

inter range operational number—A random number assigned to various Earth orbiting objects assigned by the joint US/Canadian North American Aerospace Defense Command (NORAD). Each GPS satellite has an individual IRON. Also called **IRON**.

intersection—The procedure of determining the horizontal position of an unoccupied point by direction observations from two or more known positions.

intersection station—A station whose horizontal position is determined by observations made from other stations. No observations are made from this station to determine its position.

ionosphere—The region of the Earth's atmosphere between the stratosphere and the exosphere approximately 50 to 250 miles above the surface of the earth.

ionospheric refraction delay—A delay in the propagation of the GPS signal caused by the signal traveling through the ionosphere.

joint operations graphic—The standard 1:250,000 scale DoD cartographic product which may be produced in three versions: JOG/G (Series 1501) is designed to meet ground requirements, JOG/A (Series 1501 Air) is designed to meet air requirements, JOG/R (Series 1501 Radar) is the air target material version in support of radar/intelligence planning and operations requirements.

kinematic positioning—A GPS differential surveying technique, whereby one GPS unit, the fixed receiver, stays on a known control point, while another unit, the rover, collects data on a constantly moving vehicle, while continually tracking four or more satellites during the observation period. This method of GPS survey is used to determine the position of the rover receiver. Also called dynamic positioning.

L1—See L-band.

L2—See L-band.

lamert conformal conic map projection—A conformal map projection of the conical type. This projection presents all meridians as straight lines which intersect at a common point outside the boundaries of the map sheet. All parallels are represented as arcs of circles with a common center located at the intersection of the meridians. The cone can be projected either tangent or secant to the reference ellipsoid.

lamert grid—An informal designation for a coordinate system based on a Lambert conformal map projection.

latitude—The angular distance, for a specific spot on the surface of the Earth, from 0° to 90° north or south of the equator.

L-band—The radio frequency band from 390 MHz to 1550 MHz. The primary L-band signal radiated by each NAVSTAR satellite is L1 at 1575.42 MHz. The L1 beacon is modulated with the C/A and P-codes, and with the NAV message. The L2 signal is centered at 1227.50 MHz and is modulated with the P-code and NAV message.

leap second—The step adjustment made to UTC to compensate for approximately 1 second of additional time that is transmitted by UTC signals each year. Normally, UTC is decreased by exactly 1 second (i.e. the leap second) at 24 hours on the last day of December, and/or June.

least squares—A method of adjusting observations in which the sum of the squares of all of the deviations or residuals derived in fitting the observations to a mathematical model is made a minimum. Such an adjustment is based on the assumption that blunders and systematic errors have been removed from the data, and only random errors remain.

lensatic compass—A type of magnetic compass equipped with a lens which permits the observer to read the far side of the moveable dial. The scale is usually incremented in both mils and degrees.

leveling—The operations of measuring vertical distances to determine elevations.

local coordinate system—A right handed rectangular coordinate system of which the z-axis coincides with the plumb line through the origin.

local datum—The point of reference for geodetic control used exclusively in a small area. Usually identified by a proper name.

local time—Time based on the local meridian as reference, as contrasted with time based upon a time zone meridian or the meridian of Greenwich.

lock—The state of noninterruption in the reception of a radio signal.

loop traverse—A closed traverse which starts and ends at the same station. This traverse provides no check on starting position and azimuth, nor does it provide validation against systematic distance error.

loran—A long-range radio navigation position fixing system using the time difference of reception of pulse type transmissions from two or more fixed positions.

loran C—A loran position fixing system using a combination of time difference of reception and phase difference of signals from two stations to provide a line of position.

longitude—The angular distance, for a specific spot on the Earth, from 0° to 180° east or west of the Greenwich meridian, which is used by most nations as the prime or initial meridian.

magnetic north—The direction indicated by the north seeking pole of a freely suspended magnetic needle, influenced only by the Earth's magnetic field.

magnitude—Relative brightness of a celestial body. In artillery survey, there are 73 (Sun not included) accepted survey stars. Sirius (star #25) is the brightest of those stars with a magnitude of -1.6; Octanis (star #69) is the dimmest of those stars with a magnitude of +3.7.

map—A graphic representation of the Earth or a part of the Earth at an established scale, projected on a plane surface.

map projection—A systematic drawing of lines on a plane surface to represent parallels of latitude and meridians of longitude of the Earth or of a section of the earth. The type of map projection used is dependent upon the purpose of the map.

map scale—The ratio or fraction between the distance on a map or chart and the corresponding ground distance. Military maps are usually classified as one of three types: Large scale maps have a scale of 1:75,000 or larger, medium scale maps have a scale that is larger than 1:600,000 and smaller than 1:75,000, small scale maps have a scale of 1:600,000 or smaller. Standard scales for military maps are specified in STANAG 3677.

map series—A collection of map sheets usually having the same scale and cartographic specifications.

map sheet—An individual map or chart, usually part of a series.

marginal data—All explanatory information given in the margin of a map or chart which clarifies, defines, illustrates, and/or supplements the graphic portion of the map sheet. Marginal data requirements for military maps and charts are specified in STANAG 3676.

mean sea level—The average height of the surface of the sea for all stages of the tide; used as a reference (datum) for elevations and closely resembles the geoid. Also called **MSL**.

mercator map projection—A conformal map projection of the cylindrical type. This projection depicts the equator as a straight line true to scale. The meridians of longitude are represented by evenly spaced parallel lines set perpendicular to the equator. The parallels of latitude are depicted as a set of lines placed perpendicular to the meridians and therefore parallel to the equator. Conformality is maintained by increasing the space between the parallels of latitude as they increase in distance from the equator.

meridian—A north-south reference line, particularly a great circle, through the geographical poles of the Earth, from which longitudes and azimuths are determined.

Military Grid Reference System—A system used to accurately identify the unique position of a point on the Earth's surface. This system is designed for use with the UTM and UPS grid systems. Also called **MGRS**.

monitor station—One of five worldwide stations maintained by the DOD and used in the GPS control segment to monitor and control satellite clock and orbital parameters. Corrections are calculated and uploaded to each satellite at least once per day.

multipath—A phenomenon similar to “ghosts” on a television screen; whereby GPS signals from a satellite arrive at an antenna after having traversed different paths. The signal traversing the longer path may have been reflected off one or more objects (i.e., the ground, water, building, etc.) and once received by the antenna will result in a larger pseudo-range estimate and increase the error. Multipath usually results in multipath error.

multipath error—A position error resulting from radio signals traveling from the transmitter to the receiver by two paths of different electrical lengths.

nadir—That point where the extension of the plumb line beneath the observer intersects the celestial sphere.

national geodetic reference system—A system of common or relative survey control points throughout the United States and Puerto Rico as adjusted by the National Geodetic Survey (NGS). Also called **NGRS**.

NAV data—The 1500-bit navigation message broadcast by each satellite at 50 bps on both the L1 and L2 beacons. This message contains system time, clock correction parameters, ionospheric delay model parameters, and the satellite vehicle’s ephemeris and health. This information is used to process GPS signals and obtain user position and velocity. Sometimes referred to as the navigation message, satellite message, or the D-code.

NAVSTAR—NAVigation satellite timing and ranging. NAVSTAR is the name given to GPS satellites, originally manufactured by Rockwell International.

neatlines—The lines that bound the body of a map; usually parallels and meridians, they can sometimes be conventional or arbitrary grid lines.

normal—A straight line that is perpendicular to a surface or to another line.

northing—A northward (bottom to top) reading of grid values on a map.

oblate ellipsoid—An ellipsoid whose shorter axis is the axis of rotation. All current reference ellipsoids are oblate.

observer’s meridian—The great circle on the celestial sphere that passes through both celestial poles, and the observer’s zenith.

open traverse—A traverse which begins from a station of known or assumed position, but does not end on such a station. This procedure allows no verification of fieldwork or starting control.

optical plummet—See vertical collimation.

orienting line—A line of known azimuth between two points on the ground.

orthometric height—See elevation.

outage—The period of time when the dilution of precision exceeds a specified maximum.

overlapping grid—The extension of a military grid beyond its designated limits to map sheets in areas bordering grid, grid zone, or ellipsoid/datum junctions. Normally a large-scale map within 25 miles of a junction will depict the overlapping grid as tick marks located outside the neatlines of the map.

parallax—The difference in altitude of a body as seen from the center of the Earth, and from a point on the surface of the Earth. There is no apparent parallax of the fixed stars, but that of the sun and planets is measurable. Parallax makes the body appear lower than it actually is; therefore, the correction is added.

parallel—A circle on the surface of the Earth or ellipsoid, parallel to the equator, which connects all points of equal latitude.

PDOP—See DOP.

perigee—The point in the orbit of a satellite about the Earth that is the least distant from the center of the Earth.

phase measurement—A measurement expressed as a percentage of a portion of an entire wave (e.g., a sine wave). For example, a complete wavelength is 100%, one-half is 50%.

plane rectangular coordinates—A system of coordinates in a horizontal plane used to describe the positions of points with respect to an arbitrary origin. The origin is established by a pair of axes which intersect at right angles. The position of a point is determined by its distance from these axes.

plane survey—A survey in which the surface of the Earth is considered a plane. Precise results may be obtained with plane survey techniques in small areas; however, the accuracy and precision of such results will decrease as the survey increases in size.

polar distance—The side of the PZS triangle from the celestial north pole to the celestial body. The polar distance is determined by algebraically subtracting the declination of the body from 90° (1600 mils).

polar map projection—A map projection centered on a pole.

polar stereographic map projection—A stereographic projection centered on a pole of the reference ellipsoid.

polaris—The second magnitude star, Alpha, in the constellation Ursa Minor (Little Dipper). In artillery survey, it is the recommended star for astronomic observations. It is listed as star #10 and has a magnitude of 2.1. Polaris is called the North Star.

porro prism—A prism which has two reflecting surfaces at right angles to each other. It deviates the axis 180° and inverts the image in the plane in which the reflection takes place.

precise code (P-code)—A sequence of pseudo-random binary biphase modulations on the GPS carriers L1 and L2 at a chipping rate of 10.23 MHz which repeats every 267 days. It is divided into 37 one-week segments, five of which are used by the ground segment and the other 32 are available for satellite vehicles. Therefore, each SV has a unique one-week segment code which is a subset of the overall P(Y) code sequence.

precise ephemeris—The ephemeris computed after the transmission of the satellite signal and based on satellite tracking information. The broadcast ephemeris tells where the satellite is expected to be, and the precise ephemeris is where the satellite actually was.

precise positioning service—Dynamic positioning of a single receiver based on the P-code. Currently, PPS is the most accurate dynamic positioning service offered with GPS. In general, a receiver can only be considered a PPS receiver if it can use the encrypted Y-code, and negate S/A. Also called **PPS**.

precision—How close a group or sample of measurements are to each other. A group of measurements will have high precision and low accuracy if the measurements are close together yet not close to a standard or true measurement. High precision is indicated by a low standard deviation.

preferred datum—A geodetic datum selected as a base for consolidation of local independent datums within a geographical area.

prime meridian—The meridian of 0° longitude, used as the origin for measurement of longitude. Also called the Greenwich meridian.

prime vertical—The vertical circle that is perpendicular to the plane of the observer's meridian and intersects the celestial horizon at the points directly true east and west of the observer's meridian.

projection—The extension of lines or planes to intersect a given surface; the transfer of a point from one surface to a corresponding position on another surface by graphical or analytical methods.

pseudolite—A ground based GPS station that can be used in a ranging solution. The station transmits a signal with a structure similar to that of an actual GPS satellite.

pseudo-random noise—When used as a description of code, it indicates that the code has some random noise-like properties. Each GPS satellite has a unique PRN number assigned to it. Also called **PRN**.

pseudo-range—The time shift required to align a replica of a GPS code generated in the receiver with the code received from the satellite, scaled into distance by the speed of light. The time shift is the difference between the time of signal reception and the time of signal transmission where the reception is measured in the receiver time reference and the transmission is measured in the satellite time reference. Therefore, the pseudo-range contains several errors including satellite/receiver time offset and satellite ephemeris error.

pseudo-range observable—The difference between the time of transmission and the time of arrival of a particular signal transmitted by the satellite.

radial error—See error of closure, (3).

random error—Those errors not classified as blunders, systematic errors, or periodic errors. They are numerous, individually small, and each is as likely to be positive as negative.

RDOP— See DOP.

reciprocal vertical angle—A vertical angle measured over a line at both ends to eliminate (at least partly) the effects of curvature and refraction. Reciprocal observations must be made as simultaneously as practical to reduce error caused by changing refractive conditions.

reference ellipsoid—A mathematical figure used to closely approach the dimensions of the geoid in the section of the Earth's surface being considered.

refraction—The refraction of a celestial body is the apparent displacement of the body caused by the bending of light rays passing through the Earth's gravitation, and layers of varying air density. The celestial body will appear higher than it actually is; therefore, the correction is subtracted.

rejection limit—Used in survey to refer to a maximum allowable error or deviation from a standard, usually a mean value, of two or more measurements.

relief—Inequalities of elevation and the configuration of land features on the surface of the Earth which may be represented on maps or charts by contours, shading, or spot elevations.

resection—The determination of the horizontal position of a station by observed directions from that station to points with known positions.

residual—A general term denoting a quantity remaining after some other quantity has been subtracted. For example, if the true value of a measurement is subtracted from the observed value, the difference can be called a residual; it is often referred to as an error.

residual error—The difference between any value of a quantity in a series of observations, corrected for known systematic errors, and the value of the quantity obtained from the combination or adjustment of that series. Frequently used as the difference between an observed value and the mean of all observed values of a set.

reticle—A system of wires, hairs, etched lines, or the like, placed normal to the axis of a telescope at its principle focus, by means of which the telescope is sighted on a target, or by means of which readings are made on some scale such as a leveling or stadia rod.

revolution—The turning of a body about an exterior point or object. The Earth revolves around the sun on a 600 million mile orbit at a speed of about 18.5 miles per second.

right ascension—The right ascension (RA) of a celestial body is the arc on the celestial equator measured from the vernal equinox eastward to the hour circle of the body. It is measured in units of time from 0 to 24 hours. Right ascension roughly corresponds to longitude on Earth.

root mean square— See Standard Deviation.

rotation—The turning of a body on its axis. The body usually rotates around its north-south axis; the Earth rotates from west to east.

satellite surveying—(1) (Doppler) The process of positioning one or more points on the Earth's surface by collecting Doppler shift data from passes of Navy navigation satellites. (2) (NAVSTAR GPS) The process of positioning one or more points by resection with signals received from Global Positioning Satellites.

scale factor—A multiplier for reducing a distance from a map to the actual distance on the datum of the map. Scale factor is dependent on the map projection.

S-code—Another name for C/A-code.

secant—A line that intersects a geometric curve or surface at two or more points. For example, a cone that is secant to an ellipsoid, intersects the ellipsoid at two different parallels of latitude.

secondary grid—An obsolete grid shown on maps in conjunction with the primary grid. An example is a map sheet with UTM as the primary grid and British National as a secondary grid.

selective availability—The DOD policy of intentionally degrading the accuracy of the C/A-code.

semi-major axis—One-half of the longest diameter of an ellipse.

semi-minor axis—One-half of the shortest diameter of an ellipse.

sidereal time—Time determined by the stars. A sidereal day is 3 minutes and 56 seconds shorter than a 24-hour day.

simultaneous measurements—A measurement or set of measurements referred to the same epoch.

single differencing—See differencing.

slow switching channel—A channel that switches with a period too long to recover the integer part of the carrier phase.

solar time—Time determined by the sun. A solar day is 24 hours in duration.

solstice—The solstice occurs at two points on the ecliptic midway between each equinox. When the ecliptic is north of the celestial equator, the midpoint is called the summer solstice and occurs about 21 June. When the ecliptic is south of the celestial equator, the midpoint is called the winter solstice and occurs about 21 December. The solstice occurs when the Sun is at its greatest distance north or south of the equator.

space segment—The portion of the GPS system with the major components in space; consists mainly of the satellites.

spherical coordinates—A coordinate system used to locate points on the celestial sphere. The two systems currently in use are the horizon and equator systems. Artillery surveyors use the equator system. The origin for this system is the vernal equinox and the celestial equator. See celestial coordinates.

spheroid—See ellipsoid.

spot elevation—A point on a map or chart whose elevation is noted, usually not monumented.

squaring-type channel—A receiver channel that multiplies the received signal by itself to obtain a second harmonic of the carrier which does not contain the code modulation.

standard deviation—(1) The range of how close the measured values are from the arithmetic average. A low standard deviation indicates that the measurements or observations are close together. (2) The square root of the quantity obtained by

dividing the sum of the squared errors by the number of errors minus one. Also called standard error and root mean square (RMS).

standard positioning service—Positioning of a single receiver based on the C/A-code.

state plane coordinate system—The plane-rectangular coordinate systems established by the National Geodetic Survey (NGS), one for each state in the US, for use in defining positions of geodetic stations in terms of plane-rectangular (X, Y) coordinates.

stereographic map projection—A perspective, conformal, map projection on a tangent plane, with the point of projection at the opposite end of the diameter of the sphere from the tangent plane.

stop-and-go kinematics surveying—A GPS differential survey technique whereby one GPS receiver, the fixed receiver, remains on a station of known position while the other receiver, the rover, collects signals on an unknown station for a short period of time, then moves to subsequent points to collect signals for another short period of time, all the while, continually tracking four or more satellites during the observation period. This technique is used to determine the position of the rover receiver.

survey—The act or operation of making measurements for determining the relative positions of points on, above, or beneath the Earth's surface.

survey, geodetic—Survey procedures that take into effect the size and shape of the Earth. A reference ellipsoid that mathematically represents the geoid and the horizontal and vertical datums is used.

survey, plane—Those survey procedures in which the curvature of the Earth is not usually considered and computations of relative positions are made using the principles of plane geometry and plane trigonometry.

switching channel—A channel that is sequenced through a number of satellite signals at a rate that is slower than and asynchronous with the message data rate.

systematic error— See accumulative error.

tangent—A line, curve, plane or other geometric figure that touches another geometric figure in only one point.

theodolite—A precision surveying instrument consisting of an alidade with a telescope. It is mounted on an accurately graduated circle and is equipped with necessary levels and reading devices. Sometimes the alidade includes a graduated vertical circle.

time tag—The time appended to a GPS measurement.

time zone—An area in all parts of which the same time is kept. In general, the world is divided into 24 time zones, each 15° wide and centered on a meridian whose longitude is evenly divisible by 15. In many areas of the world, political time zones are observed which means that the standard time zone has been expanded to cover the entire political boundary of the area.

topographic map—A map which presents the vertical position of features in measurable form as well as their horizontal positions.

translocation—See differential positioning.

transverse mercator map projection—A conformal, cylindrical map projection, being in principle equivalent to the Mercator map projection turned (transverse) 90° in azimuth. In this projection, the central meridian of each 6° zone is represented by a straight line. The cylinder can be tangent to the ellipsoid but is usually considered to be secant to the ellipsoid.

traverse—A method of surveying in which distances and azimuths between stations are determined for use in the computations of the positions of the stations.

triangulation—A method of surveying in which interior angles of single or adjacent triangles are measured to determine the position of stations located at the vertices of each triangle.

trig list—A list of essential information of accurately located survey control points, both horizontal and vertical. For military units, guidance for these listings is provided in STANAG 2210.

trilateration—A method of surveying wherein the lengths of the triangle sides are measured, usually by electronic methods, and the angles are computed from the measured lengths.

triple differencing— See differencing.

troposphere—The inner layer of the atmosphere, located between 6 and 12 miles above the Earth's surface.

true north—The direction from an observer's position to the geographical North Pole. The north direction of any geographic meridian.

undulation—The dips and swells that are the surface of the geoid.

universal polar stereographic grid—A military grid system based on the polar stereographic map projection. Applied to maps of the Earth's polar regions north of 84° N latitude and south of 80° S latitude. Also called **UPS grid**.

universal time—Standard universally accepted time based on the Greenwich meridian.

universal time coordinated—A uniform time system based on an atomic second maintained within 1 second of true time (UT1 and UT2) by the addition or deletion of leap seconds. Also called **UTC**.

universal transverse mercator grid—A military grid system based on the transverse mercator map projection. Applied to maps between the latitudes of 84° N and 80° S. Also called **UTM grid**.

user equivalent range error—A term for GPS measurement accuracy which represents the combined effects of ephemeris uncertainties, propagation errors, clock and timing errors, and receiver noise. A high UERE may indicate that S/A has been imposed on the satellite. Also called **UERE**.

user segment—The portion of the GPS system that is directly interfaced by the user; mainly GPS receivers.

vertical dilution of precision—See DOP.

vector—See baseline.

vernal equinox—The imaginary point on the celestial sphere where the apparent annual path of the sun crosses the celestial equator moving from south to north. The point from which right ascension is measured.

vertical—The line perpendicular to the geoid at any point. It is the direction of which the force of gravity acts.

vertical angle—(1) An angle in a vertical plane. (2) A vertical angle can be either the angle formed between the zenith and a line to a point (zenith distance) or the angle formed between the horizon and a line to a point (altitude). The zenith distance and altitude are

complimentary angles. In artillery survey the second is used. Our instruments provide a zenith distance which we have termed the vertical reading. This reading is applied to 1600 mils (4800 mils in reverse mode) to compute the vertical angle.

vertical circle—Any great circle on the celestial sphere that passes through the observer's zenith-nadir.

vertical collimation—A telescope so mounted that its collimation axis can be made to coincide with the vertical (or direction of the plumb line). The vertical collimator serves as an optical plumb; it is usually designed for use in placing a mark on the ground directly under an instrument or for placing an instrument directly over a mark on the ground. Also called optical plummet.

World Geodetic System—One of several Earth-centered Earth-fixed ellipsoid/datum systems which positions its origin at the center of the Earth's mass. Designed by the DoD to replace local datums, WGS-84 is the current system in use. Also called **WGS**.

X-axis—(1) In a system of plane rectangular coordinates, the x-axis is the line on which distances to the right or left (east or west) of the reference line are marked and measured. (2) In a three dimensional system (i.e. Cartesian coordinates) the x-axis is the line that lies perpendicular to the y-z plane and intersects that plane at its origin. An x-coordinate is the length of a line in the x-y plane that is parallel to the x-axis and measured from the y-z plane.

Y-axis—(1) In a system of plane rectangular coordinates, the y-axis is the line on which distances above or below (north or south) of a reference line are marked and measured. (2) In a three dimensional system (i.e. Cartesian coordinates) the y-axis is the line that lies perpendicular to the x-z plane and

intersects that plane at its origin. A y-coordinate is the length of a line in the x-y plane that is parallel to the y-axis and measured from the x-z plane.

Y-Code—Essentially the P-code after encryption.

Z-axis—In a three dimensional coordinate system (i.e. Cartesian coordinates), the z-axis is the line that lies perpendicular to the x-y plane and intersects that plane at its origin. The z-axis coincides with the rotational axis of a reference ellipsoid. A z-coordinate is the length of a line that is parallel to the z-axis and is measured from the intersection of the x-coordinate and y-coordinate to a point on the surface of the Earth.

Z-count word—The GPS satellite clock time at the leading edge of the data subframe of the transmitted NAV data message.

Z-time— See Greenwich Mean Time.

zenith—The point where the extension of the plumb line overhead intersects the celestial sphere.

zenith distance—A vertical angle measured from the zenith to a point or object.

zenith-nadir—The zenith and nadir for any place on the surface of the Earth are two points where an extension of the observer's plumb line intersects the celestial sphere. The zenith is the point directly overhead, the nadir is the point directly below.

zero-velocity correction—A term used with inertial survey systems, particularly the Position and Azimuth Determining System (PADS), which refers to a method of minimizing navigation errors. Whenever the vehicle is stopped, the system measures its velocity errors and the computer applies corrections to the accelerometer data.

APPENDIX F. REFERENCES AND RELATED PUBLICATIONS

Standardization Agreements (STANAGs)

2210	Trig Lists (Lists of Geodetic Data)
2211	Geodetic Datums, Ellipsoids, Grids, and Grid References
2934	Artillery Procedures
3676	Marginal Information on Land Maps, Aeronautic Charts, and Photomaps
3677	Standard Scales for Land Maps and Aeronautic Charts

National Imagery and Mapping Agency (NIMA)

DMA TR 80-003 Edition 5	Geodesy for the Layman
DMA TM 8358.1 Edition 1	Datums, Ellipsoids, Grids, and Grid Reference Systems
DMA TM 8358.2 Edition 1	The Universal Grids: Universal Transverse Mercator (UTM) and Universal Polar Stereographic (UPS)
NIMA TR 8350.2 Edition 3	DOD World Geodetic System 1984: Its Definition and Relationships with Local Geodetic Systems
MIL-HDBK-850	MILITARY HANDBOOK: Glossary of Mapping, Charting, and Geodetic Terms

National Oceanographic and Atmospheric Agency (NOAA) Technical Memoranda

NOS NGS-16	Determination of North American Datum 1983 Coordinates of Map Corners
NOS NGS-43	Performing Centimeter-Level Surveys in Seconds With GPS Carrier Phase: Initial Results
NOS NGS -50	NADCON

NOAA Technical Reports

NOS 73 NGS 8	Control Leveling
NOS 88 NGS 19	Horizontal Control
NOS 110 NGS 32	Orthometric Height Determination Using GPS Observations and the Integrated Geodesy Adjustment Model
NOS 121 NGS 39	National Geodetic Survey Gravity Network

NOAA Manuals

NOS NGS 1	Geodetic Bench Marks
NOS NGS 3	Geodetic Leveling
NOS NGS 5	State Plane Coordinate System of 1983

NOAA Professional Paper

NOS 2 North American Datum of 1983

Federal Geodetic Control Subcommittee (FGCS) Publications

Geometric Geodetic Accuracy Standards And Specifications for Using GPS Relative Positioning Techniques

NGS Charting & Geodetic Services Bull. Geod. 59

Standards and Specifications For Geodetic Control Networks

Use and Value of a Geodetic Reference System

Input Formats and Specifications of the National Geodetic Survey Data Base:
Volumes 1, II, and III

U.S. Army Engineer Manuals (EMs)

1110-1-1002 Survey Markers and Monumentation

1110-1-1003 NAVSTAR Global Positioning System Surveying

U.S. Army Field Manuals (FMs)

5-36 Route Reconnaissance and Classification

5-232 Topographic Survey

5-233 Construction Surveying

5-553 General Drafting

6-2 Tactics, Techniques, and Procedures for Field Artillery Survey

6-20-10 Tactics, Techniques, and Procedures for the Targeting Process

6-30 Tactics, Techniques, and Procedures for Observed Fire

6-50 Tactics, Techniques, and Procedures for the Field Artillery Cannon Battery

6-121 Tactics, Techniques, and Procedures for Field Artillery Target Acquisition

21-26 Map Reading and Land Navigation

21-31 Topographic Symbols

101-5-1 Operational Terms and Graphics

Marine Corps Technical Manuals (TMs)

08837A-12/1A Operators and Organizational Maintenance Manual for Position and Azimuth Determining System, AN/USQ-70

9-1290-262-10 Aiming Circle, M2A2

Miscellaneous

Distomat TM Wild DI3000 User Manual