



MCTP 3-10E
(Formerly MCWP 3-16.1)

Artillery Operations



U.S. Marine Corps

DISTRIBUTION STATEMENT A: Approved for public release; distribution is unlimited.



PCN 147 000040 00

DEPARTMENT OF THE NAVY
Headquarters United States Marine Corps
Washington, D.C. 20350-3000

4 April 2018

CHANGE 1 to MCTP 3-10E
Artillery Operations

1. This publication has been edited to ensure gender neutrality of all applicable and appropriate terms, except those terms governed by higher authority. No other content has been affected.
2. File this transmittal sheet in the front of this publication.

Reviewed and approved this date.

BY DIRECTION OF THE COMMANDANT OF THE MARINE CORPS



ROBERT S. WALSH
Lieutenant General, U.S. Marine Corps
Deputy Commandant for Combat Development and Integration

Publication Control Numbers:

Publication: 147 000040 00

Change: 147 000040 01

CD&I (C 116)

2 May 2016

ERRATUM

to

MCWP 3-16.1

ARTILLERY OPERATIONS

1. Change all instances of MCWP 3-16.1, *Artillery Operations*, to MCTP 3-10E, *Artillery Operations*.
2. Change PCN 143 000093 00 to PCN 147 000040 00.
3. File this transmittal sheet in the front of this publication.

PCN 147 000040 80

DEPARTMENT OF THE NAVY
Headquarters United States Marine Corps
Washington, DC 20380-1775

29 May 2002

FOREWORD

Marine Corps Warfighting Publication (MCWP) 3-16.1, *Artillery Operations*, provides an overview of fundamentals, organization, support requirements, and tactical considerations used by Marine artillery regiments, battalions, and batteries in support of Marine air-ground task force (MAGTF) operations.

This publication standardizes artillery procedures and provides guidelines for field artillery commanders and their staffs at all echelons of command for the efficient and effective exercise of artillery operations throughout the MAGTF. MCWP 3-16.1 also provides guidance for the assignment of artillery missions, organization for combat, fire planning, and tactical employment of artillery weapons. MCWP 3-16.1 embodies the Marine Corps' warfighting philosophy as established in Marine Corps Doctrinal Publication (MCDP) 1, *Warfighting*, and MCDP 1-0, *Marine Corps Operations*, to establish a dynamic, operational infrastructure that provides artillery support to Marine forces.

MCWP 3-16.1 supersedes Fleet Marine Force Manual (FMFM) 6-9, *Marine Artillery Support*, dated 29 June 1993.

Reviewed and approved this date.

BY DIRECTION OF THE COMMANDANT OF THE MARINE CORPS

EDWARD HANLON, JR.
Lieutenant General, U.S. Marine Corps
Commanding General
Marine Corps Combat Development Command

Publication Control Number: 143 000093 00

TABLE OF CONTENTS

Chapter 1 Fundamentals and Organization

Mission of Marine Artillery	1-1
Tactical Employment Considerations.....	1-1
Combat Tasks	1-1
Artillery Fire Support System.....	1-1
Organization for Combat	1-1
Supporting Commander's Role	1-2
Command Relationships.....	1-2
Organic	1-2
Attached	1-2
Support	1-3
Command Relationship Communications Responsibilities	1-3
Senior to Subordinate	1-3
Adjacent Units	1-3
Supporting to Supported.....	1-3
Reinforcing to Reinforced	1-3
Attached Units	1-3
Tactical Missions	1-3
Direct Support.....	1-4
Reinforcing	1-5
General Support	1-5
General Support-Reinforcing	1-5
Nonstandard Tactical Missions.....	1-5
On-Order.....	1-5
Decentralized/Centralized Control	1-6
Organization for Combat for MAGTF Operations.....	1-6

Chapter 2 Regiment Operations

Section I Regiment Organizational Structure

Mission	2-1
Functions and Employment	2-1
Combat Service Support Capabilities.....	2-2
Maintenance	2-2
Supply.....	2-3
Transportation.....	2-3
General Engineering.....	2-3
Health Services	2-3
Services.....	2-3
Messing.....	2-3
Survey and Meteorology.....	2-3

Duties And Responsibilities of Regiment Operations Personnel	2-3
Regiment Commander	2-3
Assistant Fire Support Coordinator.	2-4
Regiment Operations Officer	2-4
Regiment Assistant Operations Officer/Fire Direction Officer/ Watch Officer	2-4
Target Information Officer	2-4
Fires Tactical Systems Officer	2-5
Regiment Operations Chief.	2-5
Regiment Assistant Operations Chief/Watch Chief	2-5
Tactical Precepts	2-5
Tactical Planning Considerations	2-5

Section II Command and Control Agencies

Fire Support Coordination Center.	2-6
Regiment Combat Operations Center	2-6
Main Combat Operations Center	2-6
Forward Combat Operations Center	2-6
Administrative and Logistics Operation Center	2-7
Alternate Division Command Post	2-7
Alternate Regiment Combat Operations Center	2-8
Continuity of Operations.	2-8
Alternate Division Command Post	2-8
Alternate Regiment Combat Operations Center	2-9
Actions upon Assumption of Control	2-9
Regiment Planning Cell	2-10
Regiment Fire Direction Center	2-10
Fire Direction Objectives	2-10
Organization	2-10
Tactical Fire Direction	2-10
Targeting and Counterfire Activities	2-11
Movement and Positioning	2-11
Clearance to Fire	2-11
Request for Reinforcing Fires.	2-12
Forms, Records, and Charts	2-12
Reporting.	2-14
Other Functions of the Regiment Fire Direction Center.	2-15

Section III Regiment Survey

Mission	2-15
Duties of the Regiment Survey Officer.	2-15
Duties of the Survey Chief.	2-16
Duties of the Chief of Party (Conventional and Position and Azimuth Determining System)	2-16
Duties of the Survey Recorder/Computer.	2-16
Duties of the Instrument Operator	2-16

Survey Information Center 2-16
 Regiment Survey Methods 2-16

Section IV Regiment Meteorology

Mission 2-17
 Computer 2-17
 Ballistic 2-17
 Fallout 2-17
 Target Acquisition 2-17
 Limited Source Observation 2-17
 Duties of the Regiment Meteorology Officer 2-18
 Duties of the Regiment Meteorology Chief 2-18
 Coordination of Assets 2-18
 Meteorological Operations 2-18
 Meteorological Site Selection 2-18
 Tactical Situation 2-18
 Coordination of Assets 2-19
 Communications 2-19
 Supported Units 2-19
 Supporting Units 2-19
 Measuring Atmospheric Conditions 2-19
 Requirements and Dissemination of Data 2-20

Section V Counterbattery Radar Platoon

Mission 2-20
 AN/TPQ-46A Capabilities 2-20
 AN/TPQ-37 Capabilities 2-21
 Radar Team Employment 2-22
 Offensive Operations 2-22
 Defensive Operations 2-23
 Positioning 2-23
 Cueing 2-24
 Zone Management 2-24
 Command and Control 2-25
 Counterfire Headquarters 2-25
 Target Processing Center Employment 2-25
 Integration 2-25
 Target Production 2-25
 Target Selection Standards 2-26
 Target Production Map 2-26
 Information Flow 2-26
 Battle Damage Assessment 2-27
 Quickfire Operations 2-27

Chapter 3 Movement and Positioning of the Regiment

General	3-1
Reconnaissance Methods	3-1
Map Reconnaissance.....	3-1
Air Reconnaissance.....	3-1
Ground Reconnaissance	3-1
Reconnaissance for Movement of the Regiment	3-1
Battalion Position Areas	3-2
Regiment Headquarters Echelons.....	3-2
Counterbattery Radar Platoon.....	3-2
Meteorology Station	3-2
Route Reconnaissance.....	3-2
Route Priorities	3-2
Selecting the Position (Advance Party Operations)	3-3
Site Selection.....	3-3
Actions Prior to Occupation	3-3
Organizing the Position.....	3-3
Occupying the Position.....	3-4
Actions Upon Arrival of the Forward Combat Operations Center ..	3-4
Passage of Command and Control	3-4
Actions Upon Arrival of Main Body	3-5
Displacement.....	3-5
Execution	3-5
Methods	3-5

Chapter 4 The Artillery Defense Plan

General	4-1
Combat Operations Center Security	4-1
Evaluate the Threat	4-1
Avoid Detection	4-2
Use Camouflage	4-2
Reduce Electronics Signature	4-2
Maintain Light and Noise Discipline	4-2
Reduce Weapons Signature	4-2
Establish a Track Plan.....	4-2
Use Dispersion	4-2
Practice Communications Security.....	4-2
Displace.....	4-3
Conduct Terrain Analysis Using KOCO A	4-3
Key Terrain	4-3
Observation and Fields of Fire	4-3
Cover and Concealment	4-4
Obstacles.....	4-4
Avenues of Approach	4-4

Provide Early Warning	4-4
Sentinel Posts and Listening Posts	4-4
Patrols	4-4
Monitoring the Tactical Situation	4-5
Other Measures	4-5
Make Defensive Preparations	4-5
Organizing the Defense	4-5
Defensive Diagram	4-6
Range Cards	4-6
Fortifications and Obstacles	4-6
Hardening of Positions	4-6
Reaction Force	4-6
Coordinate with Adjacent Units for Mutual Support	4-7
Execute Defensive Action	4-7
Active and Passive Defensive Measures	4-7
Signals	4-8
Defense Against Air Attack	4-8
NBC Defense	4-8
Ground Attack	4-8
Reconstituting the Unit	4-8
Special Considerations for Command Elements	4-8

Chapter 5 Battalion Operations

Mission	5-1
Organization	5-1
Functions and Employment	5-1
Duties and Responsibilities of Battalion Operations Personnel	5-1
Battalion Commander	5-1
Battalion Liaison Officer	5-2
Battalion Operations Officer	5-2
Battalion Assistant Operations Officer/Fire Direction Officer/ Watch Officer	5-3
Battalion Operations Chief	5-3
Battalion Assistant Operations Chief	5-3
Tactical Policies	5-3
Battalion Combat Operations Center	5-4
Battalion Fire Direction Center	5-5
Centralized Tactical Fire Directoin	5-5
Decentralized Tactical Fire Direction	5-5
Provision for Continuous Support	5-6
Fire Missions from Other Sources	5-6
Reinforcing Artillery	5-6
Movement and Positioning	5-6
Other Battalion Fire Direction Center Functions	5-6
Special Missions	5-6

Battalion Survey	5-7
Battalion Survey Officer	5-7
Survey Chief	5-7
Chief of Party (Conventional and Position and Azimuth Determining System)	5-7
Survey Recorder/Computer	5-7
Instrument Operator	5-7
Battalion Survey Methods	5-7
Station Marking	5-8
Firing Position Data Card	5-8
Priority of Survey	5-8
Reconnaissance for Movement of the Battalion	5-8
Planning the Reconnaissance	5-8
Movement Briefing	5-9
Battalion Reconnaissance Party	5-10
Battalion Positioning	5-10
Battery Positioning	5-11
Additional Positioning Considerations	5-11

Chapter 6 Firing Battery Operations

Section I Fundamentals

Mission	6-1
Organization	6-1
Functions and Employment	6-1
Duties Of Firing Battery Personnel	6-1
Battery Commander	6-1
Executive Officer	6-1
Liaison Officer	6-3
Fire Direction Officer	6-3
Assistant Executive Officer	6-3
First Sergeant	6-3
Battery Gunnery Sergeant	6-3
Operations Chief	6-3
Assistant Operations Chief	6-3
Motor Transport Chief	6-3
Ammunition Chief	6-4
Local Security Chief	6-4
Communications Chief	6-4
Howitzer Section Chief	6-4

Section II Fire Direction

Fire Battery Procedures with the Battery Computer System	6-4
Gunnery	6-4
Fire Direction Center Functions	6-5
Fire Direction Center Journal	6-6
Standards	6-6

Section III Battery Operations Center	
Purpose	6-6
Passage of Control	6-6
Passing Control Back	6-6
 Section IV Gun Line Procedures	
Purpose	6-7
Special Missions	6-7
Priority Target	6-7
Final Protective Fires	6-7
Fire Plans	6-7
Direct Fire	6-7
Out of Traverse	6-7
 Section V Movement and Positioning of the Firing Battery	
Reconnaissance	6-8
Reconnaissance Tasks	6-8
Selecting the New Position	6-8
Firing Position Characteristics	6-8
Types of Positions	6-9
Advance Party	6-10
Composition	6-10
Assembly of the Advance Party	6-10
Firing Capability	6-10
Advance Party Tasks	6-11
Organizing the New Position	6-13
Movement of the Main Body	6-13
Planning the Move	6-13
Other Considerations	6-13
Conducting the Move	6-13
Occupying the Position	6-14
Deliberate Occupation	6-14
Hasty Occupation	6-14
Night Occupation	6-15
Emergency Occupation (Hip Shoot)	6-16
Local Security and Patrolling	6-16
Hasty Displacements	6-16
Emergency Displacement	6-16
 Chapter 7 Force Artillery	
Mission	7-1
Concept of Employment	7-1
Tasks	7-1
Command Relationships	7-2
Liaison	7-2
Force Artillery Intelligence Section	7-3

Target Acquisition	7-3
Counterfire	7-3
Meteorological Support	7-4
Survey Support	7-4
Communications	7-4
Logistics	7-5

Chapter 8 Artillery Communications

General	8-1
Forms of Communications	8-1
Means of Communications	8-1
Radio	8-1
Wire	8-1
Messenger	8-1
Communications System Planning	8-2
Security	8-2
Communication Nets	8-2
Artillery Regiment Communication Nets	8-2
Division Command Net	8-2
Division Tactical Net	8-2
Division Artillery Air Spot Net	8-2
Division Fire Support Coordination Net 1	8-3
Division Fire Support Coordination Net 2	8-3
Division Communication Coordination Net	8-3
Division Intelligence Net	8-3
Artillery Regiment Command Net	8-3
Artillery Regiment Tactical Net	8-3
Artillery Regiment Fire Direction Net	8-3
Artillery Regiment Survey/Met Net	8-3
Artillery Regiment Radar Telling Net	8-4
Artillery Regiment Communication Coordination Net	8-4
Artillery Battalion Communication Nets	8-4
Artillery Battalion Command Net	8-4
Artillery Battalion Fire Direction Net	8-4
Artillery Conduct of Fire Net	8-4
Artillery Battery Communication Nets	8-5
Artillery Battery Command Net	8-5
Artillery Conduct of Fire Net	8-5
DS Artillery Battalion Communication Nets	8-5
Alternate Uses of Nets	8-5

Chapter 9 Artillery Tactical Logistics

Section I Fundamentals

Background	9-1
Logistics Principles	9-1

Artillery S-4 Duties	9-1
Supervising the Ammunition Plan	9-1
Maintaining Ammunition	9-1
Recording and Disseminating Information	9-1
Coordinating Transportation Requirements	9-1
Supervising Management Maintenance Resources	9-2
Concept of Support and Logistic Capabilities	9-2
Organic	9-3
External Combat Service Support Organizations	9-3
Section II Planning	
General	9-3
MAGTF Artillery Officer	9-3
Artillery Commander and Staff	9-4
METT-T	9-4
Mission	9-4
Enemy	9-4
Terrain and Weather	9-4
Troops and Support Available-Time Available	9-4
Evaluating Logistic Data	9-4
Supply	9-6
Class I	9-7
Class II	9-7
Class III	9-8
Class IV	9-9
Class V	9-10
Class VI	9-12
Class VII	9-12
Class VIII	9-12
Class IX	9-12
Class X	9-12
Transportation	9-12
Embarkation	9-12
Helicopter Movement	9-13
Fixed-Wing Air Transport	9-13
Movement by Rail	9-13
Motor Transport	9-14
Maintenance	9-14
Supply Support Planning	9-14
Maintenance Contact Team	9-14
Recovery and Evacuation Procedures	9-14
Health Services	9-14

Section III Execution

Battalion Logistic Organization	9-15
Decentralized Support.	9-15
Centralized Support.	9-15
Distribution	9-15
Unit Distribution	9-15
Point Distribution	9-15
Supply Systems	9-16
Pull System	9-16
Push System	9-16
Organization of Logistic Trains	9-16
Battalion Trains.	9-16
Regiment Trains	9-16
Positioning Trains	9-17
Conducting Train Operations	9-17
Security	9-18
Refueling Operations	9-19
Ammunition Operations	9-19
CSSE Responsibilities.	9-19
Artillery Battalion Responsibilities.	9-20
Pre-positioned Ammunition Stock	9-20
Unit Ammunition Supply Points.	9-20
Ammunition Management	9-21
Maintenance Operations	9-21
Maintenance Support	9-22
Maintenance Site Selection.	9-22
Recovery and Salvage.	9-23
Captured Materiel	9-23
Equipment Destruction	9-23
Cannabilization	9-23
Engineer Operations	9-23
Battery Position Preparation	9-23
Vehicle Positions.	9-23
Weapon Emplacements.	9-23
Ammunition Shelters	9-24

Chapter 10 Developing the Artillery Fire Plan

Section I Essential Fire Support Tasks and Essential Field Artillery Tasks Relationship

General	10-1
Essential Fire Support Tasks.	10-1
Essential Field Artillery Tasks	10-1

Section II The Marine Corps Planning Process as it Applies to the Artillery Fire Plan

General 10-4

Mission Analysis 10-4

 Analyze Higher Headquarter’s Order 10-4

 Conduct the Initial Intelligence Preparation of the Battlespace 10-4

 Determine Specified, Implied, and Essential Tasks 10-4

 Review Available Assets 10-4

 Determine Constraints 10-5

 Identify Critical Facts and Assumptions 10-5

 Determine Initial Commander’s Critical Information Requirements 10-6

 Determine the Initial Reconnaissance Annex 10-7

 Plan Use of Available Time 10-7

 Write the Restated Mission 10-7

 Conduct a Mission Analysis Brief 10-8

 Develop the Initial Commander’s Intent 10-9

 Issue the Commander’s Guidance 10-10

 Issue a Warning Order 10-10

 Review Facts and Assumptions 10-11

Course of Action Development 10-12

 Intelligence Preparation of the Battlespace 10-12

 Array Friendly Forces 10-13

 Assess Relative Combat Power 10-13

 Refine Center of Gravity Analysis 10-13

 Develop Initial Courses of Action 10-13

 Course of Action Graphic and Narrative 10-13

 Course of Action Criteria 10-13

 Prepare Course of Action Briefing 10-14

 Select/Modify Courses of Action 10-14

Course of Action Wargaming 10-14

 Step 1: Consider the Commander’s Wargaming Guidance and Evaluation Criteria 10-15

 Step 2: Gather the Tools 10-15

 Step 3: List Friendly Force List 10-16

 Step 4: List Assumptions 10-16

 Step 5: List and Graphically Display Known Critical Events and Decision Points 10-17

 Step 6: Select the War Game Method 10-17

 Step 7: Select Method to Record and Display Results 10-17

 Step 8: Wargame the Battle 10-17

 Step 9: Refine Staff Estimates and Contributions 10-17

 Step 10: Prepare Course of Action War Game Brief 10-19

Course of Action Comparison and Decision	10-19
Course of Action Evaluation	10-19
Course of Action Comparison	10-19
Commander's Decision	10-20
Prepare Concept of Artillery Support	10-20
Issue the Warning Order	10-20
Orders Development	10-21
Preparation of the Order or Plan	10-22
Order Reconciliation	10-24
Orders Crosswalk	10-24
Commander's Approval of Order or Plan	10-24
Transition	10-24
Orders Brief	10-24
Rehearsals	10-24

Section III Artillery and the Intelligence Preparation of the Battlespace Process

General	10-25
Pre-Battle Preparation	10-26
Threat Maneuver Force Doctrine	10-26
Threat Artillery Doctrine and Capabilities	10-26
Threat Air Defense Artillery Doctrine	10-26
Terrain	10-26
Elevations	10-26
Slope	10-26
Soil Composition	10-27
Mobility Problems	10-27
Intervisibility Lines	10-27
Avenues of Approach	10-27
Key and Decisive Terrain	10-29
Position Areas	10-29
The Modified Combined Obstacle Overlay and Course of Action Development	10-30
Situation Templating	10-30
Threat Artillery	10-30
Threat Maneuver Forces	10-31
Threat Avenues of Approach and Objectives	10-31
Threat Chemical Strikes	10-31
Rear Area Threats	10-31
Integrating the Situation Template into Course of Action Development and Wargaming	10-32
Event Templating	10-32
Decision Support Template	10-33

Section IV Sample Artillery Fire Plan

Tab B (Artillery Fire Plan) to APPENDIX 19 (Fire Support) to ANNEX C (Operations) to Operation Order (Number) (U)	10-37
--	-------

Chapter 11 Special Operational Environments

Cold Weather	11-1
Mountain.	11-2
Desert	11-2
Jungle	11-3
Riverine	11-3
River Crossing	11-4
Expeditionary	11-4
Helicopterborne	11-5
Urban	11-5
Artillery Raid	11-6
Fire Base	11-6

Appendixes

A Advanced Field Artillery Tactical Data System.	A-1
B Artillery Weapons and Munitions.	B-1
C Passage of Command and Control/Watch Officer’s Checklist.	C-1
D Reports	D-1
E Logistic Planning Data	E-1
F Heliborne Artillery Raids	F-1
G Glossary	G-1
H References	H-1

Figures

1-1 Tactical Missions (Inherent Responsibilities)	1-4
2-1 Artillery Regiment	2-1
2-2 Headquarters Battery, Artillery Regiment	2-2
2-3 Example Regiment COC Site Layout	2-7
2-4 Example FDC/COC	2-8
2-5 Example Request for Reinforcing Fires Form	2-13
2-6 Attack Guidance Matrix	2-27
5-1 Artillery Battalion	5-2
5-2 Example Battalion COC Configuration	5-4
6-1 Firing Battery	6-2
6-2 Example Battery FDC Configuration.	6-5
6-3 Advance Party	6-10
6-4 Example Battery Commander’s Position Checklist.	6-12
8-1 Example Artillery Regiment Guard Chart	8-6
8-2 Example Direct Support Artillery Battalion Guard Chart	8-7
8-3 Example General Support Artillery Battalion Guard Chart	8-8

Figures (Continued)

8-4	Example General Support-Reinforcing Artillery Battalion Guard Chart	8-9
8-5	Example Artillery Regiment Communication Structure	8-10
8-6	Example Direct Support Artillery Battalion Communications Structure	8-10
9-1	CSS Map Symbols	9-2
9-2	Replenishment and Repair Point Layout	9-18
10-1	Essential Fire Support Tasks and Essential Field Artillery Tasks Relationship	10-2
10-2	Example Essential Field Artillery Tasks	10-3
10-3	Steps in the Marine Corps Planning Process	10-4
10-4	Mission Analysis	10-5
10-5	Commander's Critical Information Requirements	10-6
10-6	Example Mission Analysis Briefing Format	10-8
10-7	Mission Analysis Briefing Checklist	10-9
10-8	Orders Process for Mission Analysis	10-11
10-9	Course of Action Development	10-12
10-10	Artillery Scheme of Maneuver	10-13
10-11	Course of Action Wargaming	10-15
10-12	Wargaming Responsibilities	10-16
10-13	Sample COA Synchronization Matrix	10-18
10-14	Staff Contributions to Wargaming	10-19
10-15	Course of Action Comparison and Decision	10-20
10-16	Advantages and Disadvantages Matrix	10-20
10-17	Comparison Matrix	10-21
10-18	Orders Development	10-21
10-19	Example Format of the Artillery Fire Plan Brief	10-22
10-20	Transition	10-24
10-21	Modified Combined Obstacle Overlay with Restricted and Severely Restricted Terrain Marked	10-28
10-22	Modified Combined Obstacle Overlay with Intervisibility Lines Identified	10-28
10-23	Modified Combined Obstacle Overlay Depicting Mobility Corridors, Avenues of Approach, Key Terrain, and Possible Position Areas	10-29
10-24	Overlay Depicting Critical Targets and Range Fans	10-31
10-25	Decision Support Template and Execution Matrix	10-35
10-26	Fire Planning Using the MCPP	10-36

Figures (Continued)

ENCLOSURE 1 (Artillery Target List) to TAB B (Artillery Fire Plan)
to APPENDIX 19 (Fire Support) to ANNEX C (Operations)
to Operation Order (Number) (U). 10-40

ENCLOSURE 2 (Artillery Synchronization Matrix) to TAB B
(Artillery Fire Plan) to APPENDIX 19 (Fire Support) to
ANNEX C (Operations) to Operation Order (Number) (U). 10-41

ENCLOSURE 3 (Artillery Target Overlay) to TAB B (Artillery Fire Plan)
to APPENDIX 19 (Fire Support) to ANNEX C (Operations)
to Operation Order (Number) (U). 10-42

ENCLOSURE 4 (Schedule of Fire) to TAB B (Artillery Fire Plan)
to APPENDIX 19 (Fire Support) to ANNEX C (Operations)
to Operation Order (Number) (U). 10-43

ENCLOSURE 5 (Observation/Target Acquisition) to TAB B (Artillery Fire
Plan) to APPENDIX 19 (Fire Support) to ANNEX C (Operations)
to Operation Order (Number) (U). 10-44

EXHIBIT 1 (Visibility Diagram) 10-47

EXHIBIT 2 (Capabilities Overlay). 10-48

EXHIBIT 3 (Radar Deployment Order). 10-49

ENCLOSURE 6 (Survey/Met Plan) to TAB B (Artillery Fire Plan)
to APPENDIX 19 (Fire Support) to ANNEX C (Operations)
to Operation Order (Number) (U). 10-50

D-1 Fire Capabilities Report (FIRECAP) D-1

D-2 Displacement Report (DISREP) D-1

D-3 Command Post Report (CPREP). D-1

D-4 Movement Order Report D-2

D-5 Situation Report (SITREP) D-2

D-6 Rapid Request D-2

D-7 Radar Report D-3

D-8 SPOTREP D-3

D-9 Shelling Report (SHELLREP) D-4

D-10 Size, Activity, Location, Unit, Time, and
Equipment (SALUTE) Report. D-4

D-11 Medical Evacuation (MEDEVAC) Report D-4

F-1 Example Raid Execution Checklist F-16

F-2 Example Planning Considerations Checklist. F-17

F-3 Example Raid Equipment List F-18

F-4 Helicopter Landing Zone Brief F-20

F-5 Example Artillery Raid Landing Zone Marking F-20

F-6 Example Howitzer Pick-Up Point Lighting. F-20

Tables

2-1	Target Acquisition Radar Planning Table	2-21
2-2	AN/TPQ-37 CEP Accuracies	2-22
5-1	Battle Positioning	5-11
9-1	Environmental Impacts on CSS	9-5
9-2	Classes of Supply	9-7
9-3	Planning Data for Rations.	9-7
9-4	Water Planning Data for Personnel	9-8
9-5	Transportation Planning Data for Drummed Fuel	9-8
9-6	Estimates of Daily Fuel Usage Rates	9-8
9-7	Consumption Rates and Capacities for Vehicles/Equipment.	9-9
9-8	Class IV Transportation Planning Data	9-9
9-9	Ammunition-Carrying Capacities.	9-11
9-10	Notional Composition of Battalion Trains	9-17
9-11	Artillery Vehicle Position Dimensions.	9-24
B-1	Fuzes	B-6
B-2	Characteristics of Selected Artillery Weapons	B-6
B-3	Projectiles and Propelling Charges (M198/M109A5/A6)	B-7
B-4	Projectiles and Propelling Charges (M109A2/A3/A4)	B-8
E-1	Headquarters Battery, Artillery Regiment, Personnel	E-1
E-2	Headquarters Battery, Artillery Regiment, Selected Major Equipment.	E-1
E-3	Headquarters Battery, Artillery Regiment, Class V Small Arms Combat Planning Rates	E-2
E-4	Headquarters Battery, Artillery Battalion, Personnel.	E-3
E-5	Headquarters Battery, Artillery Battalion, Selected Major Equipment.	E-3
E-6	Headquarters Battery, Artillery Battalion, Class V Small Arms Combat Planning Rates Composite Threat	E-4
E-7	M-198 Battery (6-Gun), Personnel.	E-5
E-8	M-198 Battery (6-Gun), Selected Major Equipment	E-5
E-9	M-198 Battery (6-Gun), Class V Small Arms Combat Planning Rates	E-6
E-10	M-198 Battery (6-Gun), Class V Artillery Ammunition Combat Planning Rates	E-7
E-11	Artillery Battalion, Personnel.	E-8
E-12	Artillery Battalion, Selected Major Equipment	E-8
E-13	Artillery Battalion, Class V Small Arms Combat Planning Rates.	E-9
E-14	Artillery Battalion, Class V Artillery Ammunition Combat Planning Rates	E-10
E-15	Ammunition Packing Dimensions, Artillery Ammunition	E-11
E-16	Ammunition Packing Dimensions, Small Arms	E-12

Tables (Continued)

F-1	Notional Artillery Battery Lift (Advanced Party)	F-10
F-2	Helicopter Life Capacity Planning Guidance	F-11
F-3	Cargo Net Capacity Planning Guidance	F-11
F-4	Example Artillery Raid Ammunition Requirements	F-11
F-5	Example Artillery Raid Task Organization	F-12
F-6	Helicopter Lift Requirement Matrix	F-13
F-7	Example Helicopter Wave and Serial Assignment Table	F-14

CHAPTER 1

FUNDAMENTALS AND ORGANIZATION

Mission of Marine Artillery

The mission of artillery is to furnish close and continuous fire support by neutralizing, destroying or suppressing targets that threaten the success of the supported unit. To accomplish its mission, artillery has the following responsibilities:

- Provide timely, close, accurate, and continuous fire support.
- Provide depth to combat by attacking hostile reserves, restricting movement, providing long-range support for reconnaissance forces, and disrupting threat command and control (C2) systems and logistics installations; i.e., shaping the battlespace.
- Deliver counterfire within the range of the weapon systems to ensure freedom of action of the ground forces.

Tactical Employment Considerations

Basic considerations for the tactical employment of artillery are as follows:

- Fire support requirement.
- Ability to mass.
- Exploitation of weapon capability.
- Facilitate future operations.
- Exploitation of mobility.

Combat Tasks

Artillery has the following combat tasks:

- Coordinate artillery support.
- Acquire targets.

- Deliver lethal and nonlethal munitions.
- Survive.
- Communicate.
- Maneuver (move).
- Maintain and resupply.
- Maintain trained and ready personnel.

Artillery Fire Support System

Artillery has three components that function together to create an effective fire support system: target acquisition, weapon systems, and C2 systems. Target acquisition is detecting, identifying, and locating a target in sufficient detail to effectively employ munitions. The weapon systems provide the means to engage the target. The C2 systems provide the required facilities, equipment, communications, and personnel that enable the commander to plan, direct, and control fires. See MCWP 3-16, *Fire Support Coordination in the Ground Combat Element*, for detailed information on the artillery fire support system and its individual components. See appendix A for detailed Advanced Field Artillery Tactical Data System (AFATDS) information. See appendix B for artillery weapons and munitions information.

Organization for Combat

Artillery is allocated through a process called organization for combat. Organization for combat places an artillery unit within an organization; i.e., establishes a command relationship and assigns the unit a tactical mission. The supported force commander uses this process to allocate artillery assets to meet the needs of the force as a whole and the needs of the force's subordinate units.

The supported force commander receives guidance from the supporting artillery commander. Organization for combat is established in the planning phase and is in consonance with the supported commander's concept of operations. It changes as the tactical situation dictates, but it will address the following:

- Adequate support for the committed maneuver elements.
- Adequate weight to support the main effort or to strengthen the most vulnerable area.
- Immediately available artillery for the commander to influence the battlespace.
- Ability to respond to unforeseen events, transition from one mission to another, and facilitate future operations.
- Ability to maintain the maximum central control.

Supporting Commander's Role

The artillery commander must know, understand, and anticipate the supported commander's actions and fire support requirements. When artillery is attached to a supported unit, the artillery commander is a subordinate commander and a special staff officer of the supported unit commander. The artillery commander must understand the scheme of maneuver and provide artillery fire support to the maneuver commander. The artillery commander provides fire support expertise to the supported commander and the force fires coordination center (FFCC)/fire support coordination center (FSCC). He/She does this by direct personal contact, through liaison officers, and by encouraging staff liaison.

Command Relationships

Command relationships define the degree of authority exercised by one commander over another. They are primarily based on the factors of mission, enemy, terrain and weather, troops and

support available-time available (METT-T). The ground combat element (GCE) commander exercises control of artillery in his/her organization through the commander of the artillery unit. For example, the decision to employ an artillery unit for a specific mission is made by the GCE commander; selecting the specific artillery unit to perform the mission is made by the artillery commander. The command relationship given (or inherent) to an artillery unit may be organic or attached.

Organic

An organic relationship occurs when an artillery unit is assigned to and forms an essential part of a larger military organization. For example, the artillery regiment is organic to the Marine division.

Attached

In an attached relationship, units or personnel are placed in an organization temporarily to augment tactical objectives. This is often referred to as tactical tailoring. The higher artillery commander will lose some capabilities to meet his/her fire support requirements by attachment. The commander receiving the attachment exercises the same degree of C2 over attachments as exercised over the units and personnel organic to his/her command, subject to the limitations stated in the attachment order. An attachment order should specify supply and maintenance requirements in terms of what the receiving unit and parent unit will provide. The parent formation, unit or organization will normally retain the responsibility for transfer and promotion of personnel. Although attachment places the artillery unit within the organization, the artillery unit must still be assigned a tactical mission. There are several types of attachments: attached to a supported unit, attached to a reinforced unit, groupment, and task-organized.

Attached to a Supported Unit

Artillery is attached to a supported unit when artillery requirements cannot be adequately provided by the parent artillery organization and control

requirements compel establishing a command relationship between the supported and supporting commander. Artillery units are normally not attached to battalion-sized or smaller maneuver units unless distance, communications or other factors do not allow the parent artillery headquarters to exercise adequate control over the artillery unit. An example is an artillery battery attached to the GCE of a Marine Expeditionary Unit (MEU).

Attached to a Reinforced Unit

Artillery may be attached to another artillery unit for reinforcement. For example, an artillery battalion supporting a reinforced infantry regiment may have attached firing batteries or counterbattery radar (CBR) platoon detachments.

Groupment

Groupment occurs when a suitable artillery headquarters is unavailable; an artillery battalion or battery may be attached to another of like size to form an artillery groupment. Artillery groupments are temporary formations used when one unit must exercise greater administrative and logistical control over another unit than is inherent in a reinforcing mission. The senior commander of the two units is the groupment commander, who assigns missions to the subordinate unit. The groupment uses the standing operating procedures (SOPs) of the groupment commander. The groupment also carries the numerical designation of the headquarters of the groupment commander; e.g., 1st Battalion Group, 11th Marines.

Task-Organized

Artillery may be task-organized to accomplish a specific task or mission. Task organization can occur during certain phases or a given duration of an operation. This may include designating an operating force, support staff or logistics package of specific size and composition. Some considerations for task-organizing include—but are not limited to—training, experience, equipment, sustainability, operating environment, the threat, and mobility.

Support

A support relationship is established by a senior commander between subordinate commanders when one organization should aid, protect, complement or sustain another force while still under the command of its parent headquarters. For example, force artillery has a support relationship with the Marine Expeditionary Force (MEF).

Command Relationship Communications Responsibilities

Senior to Subordinate

Communications between a supporting and a supported unit is the responsibility of the senior commander.

Adjacent Units

Communications between adjacent units is the responsibility of the senior commander.

Supporting to Supported

Communications between a supporting and a supported unit is the responsibility of the supporting unit commander.

Reinforcing to Reinforced

Communications between a reinforcing and a reinforced unit is the responsibility of the reinforcing unit commander.

Attached Units

Communications between a unit and an attached unit is the responsibility of the commander of the unit to which the attachment is made.

Tactical Missions

A tactical mission defines the inherent fire support responsibilities of an artillery unit, normally a

battalion, to a supported unit or to another artillery unit. All Marine cannon battalions can perform any of the four tactical missions: direct support (DS), reinforcing (R), general support (GS), and general support-reinforcing (GS-R). An artillery unit assigned a tactical mission remains under the command of the higher artillery commander. Inherent responsibilities for each type of tactical mission help provide clear, concise instructions to a supporting artillery unit. See figure 1-1.

Direct Support

The DS mission requires a unit to furnish close and continuous fires to a single supported unit, normally a regiment or separate maneuver battalion. The artillery unit commander with a DS

mission will position his/her firing units to deliver fires in the zone of action/sector of the supported unit, plan fires, and maintain continuous communications with the liaison team and forward observer (FO) teams located with the supported unit. He/She is responsible for immediate replacements for casualty losses of the liaison section.

The fires of a DS unit can be requested for other purposes. However, if these fires conflict with the delivery of fires to the supported unit, the supported unit will have priority. Normally, one artillery battalion is considered minimum adequate support for an infantry regiment. Calls for fire are answered in two methods based on the needs of the supported unit: autonomous and centralized.

Arty Unit with Tactical Mission of...	Answers Calls for Fire in Priority From...	Has As Its Zone of Fire...	Furnishes Forward Observers...	Establishes Liaison With...	Establishes Comm With...	Is Positioned By...	Has Its Fires Planned By...
DIRECT SUPPORT	1. Supported unit. 2. Own observers. 3. Higher artillery headquarters.	Zone of supported unit.	To each company-sized maneuver element of supported unit.	Supported unit (down to battalion level).	Supported unit.	Unit commander as deemed necessary or ordered by higher artillery headquarters.	Develops own fire plan.
REINFORCING	1. Reinforced unit. 2. Own observers. 3. Higher artillery headquarters.	Zone of fire of reinforced unit.	No requirement.	Reinforced unit.	Reinforced unit.	Reinforced unit or ordered by higher artillery headquarters.	Reinforced unit.
GENERAL SUPPORT	Higher artillery headquarters.	Zone of supported unit.	No inherent responsibility.	No inherent responsibility.	No inherent responsibility.	Higher artillery headquarters.	Higher artillery headquarters.
GENERAL SUPPORT-REINFORCING	1. Higher artillery headquarters. 2. Reinforced unit. 3. Own observers.	Zone of supported unit to include zone of fire of reinforced unit.	No requirement.	Reinforced unit.	Reinforced unit.	Higher artillery headquarters or reinforced unit subject to prior approval by higher artillery headquarters.	Higher artillery headquarters.

Figure 1-1. Tactical Missions (Inherent Responsibilities).

Autonomous

Each firing battery may have its own conduct of fire (COF) net, and each net is monitored by the battalion fire direction center (FDC).

Centralized

The battalion FDC may establish multiple COF nets, with firing batteries directed to respond to calls for fire received on a designated net and to fire missions assigned by the battalion FDC.

Reinforcing

An R mission requires a unit to respond directly to requests for fire from another artillery unit. This mission is used to reinforce the fires of a unit with a DS mission. More than one reinforcing unit can reinforce a DS unit; however, a reinforcing unit can only reinforce one DS unit at a time. Reinforcing artillery receives its zone of fire and fire missions from the reinforced DS unit. The reinforcing unit commander positions his/her firing units in the position areas (PAs) identified by the reinforced unit or as ordered by higher artillery headquarters.

General Support

The GS mission requires a unit to support the force as a whole and be prepared to support any subordinate element. The higher artillery headquarters controls the fires of a unit in GS. The zone of fire may be the zone of action/sector of the force as a whole or a specific portion. GS units provide the GCE immediately available firepower to influence the battle or to allocate to subordinate commands to influence widely separated actions.

General Support-Reinforcing

The GS-R mission has distinct and separate parts. An artillery unit with this mission will conduct operations in a GS role and support the force as a

whole; or the artillery unit will take on the reinforcing role and answer calls for fire from a designated artillery unit in DS. The GS tactical mission takes priority over the reinforcing mission. To increase responsiveness, a designated net (quick-fire channel) may be established between the GS-R unit and the reinforced DS unit. This tactical mission is considered the most flexible standard tactical mission.

Nonstandard Tactical Missions

When fire support requirements cannot be met or conveyed by one of the standard tactical missions, a nonstandard tactical mission may be assigned. A nonstandard mission changes or limits one or more of the inherent responsibilities of a standard tactical mission. The stipulations should not degrade the ability of a unit to accomplish the other inherent responsibilities of the standard mission. The DS mission should not be modified. The following is an example of a nonstandard tactical mission:

1st Bn, 10th Mar (155, T):GS, 2d PCFF LAR Bn until 031600 AUG

First battalion (Bn) is GS to the division and will fire missions to support the division commanding general (CG) first, but second priority in calls for fire (PCFF) is to light armored reconnaissance battalion (LAR Bn). Positioning and communications of the battalion are initially established to support LAR Bn as the main effort.

On-Order

The on-order (O/O) mission serves as a warning order to alert a unit of an anticipated change to its tactical mission. This allows artillery commanders to plan and initiate the preparation for transition to the new mission. Assignment of an O/O

mission must consider the positioning and ammunition requirements for that mission. Often, the O/O mission has a nonstandard stipulation; e.g., do not expend more than a specified amount of ammunition. The higher artillery commander gives his/her subordinate commanders as much warning as possible of the new mission's anticipated time of execution. The following is an example of an O/O mission:

1st Bn, 14th Mar (155, T):R 2d Bn, 14th Mar (155, T)

Decentralized/Centralized Control

When organizing artillery for combat, the most effective control is centralized at the highest level consistent with the fire support capabilities and requirements for the overall mission. Centralized control permits flexibility in providing artillery support to the force as a whole and to its subordinate units. Centralized control is accomplished through GS and GS-R missions and centralized fire control. Decentralized control makes artillery responsive to the needs of the frontline. Decentralized control is accomplished by the DS mission and decentralized fire control. The optimum degree of control varies with the tactical situation. The following guidelines may be used when allocating tactical missions to artillery units:

- Decentralized in the offense: more DS and R than GS and GS-R.
- Centralized in the defense: more GS and GS-R than DS and R.

Organization for Combat for MAGTF Operations

Artillery support for the MEU is normally found in the GCE. It is provided to the battalion landing team (BLT) and is typically a firing battery employed with towed howitzers and attached support; e.g., communications, maintenance, and a survey and manual meteorology capability. The M198 has the range, lethality, and ammunition variety suitable to sustain operations ashore. The MEU command element (CE) has artillery officers serving as the target information officer and as the fire support officer (FSO).

Marine Expeditionary Brigade (MEB) artillery support is normally that support provided to the regimental landing team (RLT). It typically consists of an artillery battalion employed with towed howitzers and attached support; e.g., communications, maintenance, and a survey and manual meteorology capability. The artillery battalion commander is the fire support coordinator (FSC) for the RLT.

MEF artillery support is normally that support provided to the division. However, it can be augmented by additional artillery support, usually in the form of force artillery, attachment of a United States Marine Corps Reserve (USMCR) battalion, artillery from other Marine divisions or artillery from other external sources, i.e., Army units or coalition forces. The MEF commander will designate a force fires coordinator (FFC). The MEF CE has two artillery officers serving as assistant FFCs.

CHAPTER 2

REGIMENT OPERATIONS

SECTION I. REGIMENT ORGANIZATIONAL STRUCTURE

Mission

The mission of the artillery regiment is to furnish close and continuous fire support by neutralizing, destroying or suppressing targets that threaten the success of the division.

Functions and Employment

Each MAGTF's GCE has an artillery component. At division level, artillery is organized into an artillery regiment. The artillery regiment and its elements can employ with and support the GCE of any MAGTF. Artillery supports the operations of other MAGTF elements as required.

The standard artillery regiment will have a headquarters battery and four artillery battalions to support the GCE of a MEF. See figure 2-1.

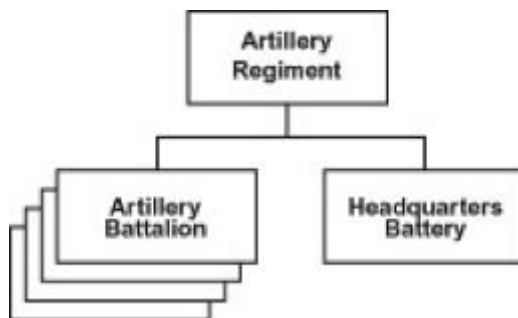

Figure 2-1. Artillery Regiment.

The headquarters battery has functional staff groupings to assist the regiment commander

control operations and provide combat service support (CSS) and administrative support of the regiment. See figure 2-2 on page 2-2. Headquarters battery provides the equipment and personnel for the regiment's command echelons. It also provides personnel and equipment to the division FSCC. Headquarters battery personnel may be employed to augment an artillery battalion operating independently of the regiment.

The regiment headquarters may be employed in two echelons: a main echelon, which has the staff and equipment to direct tactical operations; and the rear echelon, which has the staff and equipment to direct sustainment operations. A forward echelon may be formed from the staff and equipment of the main echelon for incremental displacement of the main echelon. Combat operations centers (COCs) are formed at each echelon to plan, direct, control, and coordinate assigned functions for the commander. The regiment commander positions himself/herself where he/she can best exercise C2 of the regiment and function as both the division artillery officer and FSC.

The regiment commander organizes for combat based on the GCE commander's guidance. Each artillery battalion is then assigned a tactical mission, which defines its inherent fire support responsibilities. The regiment main COC performs tactical fire direction, targeting, and counterfire functions. The hub of artillery operations is the FDC, normally located at the main or forward COC. Communications are established with subordinate units and higher/supported unit headquarters. Normally, one of the artillery battalion COCs will be designated as the alternate regiment command post (CP). A regiment COC,

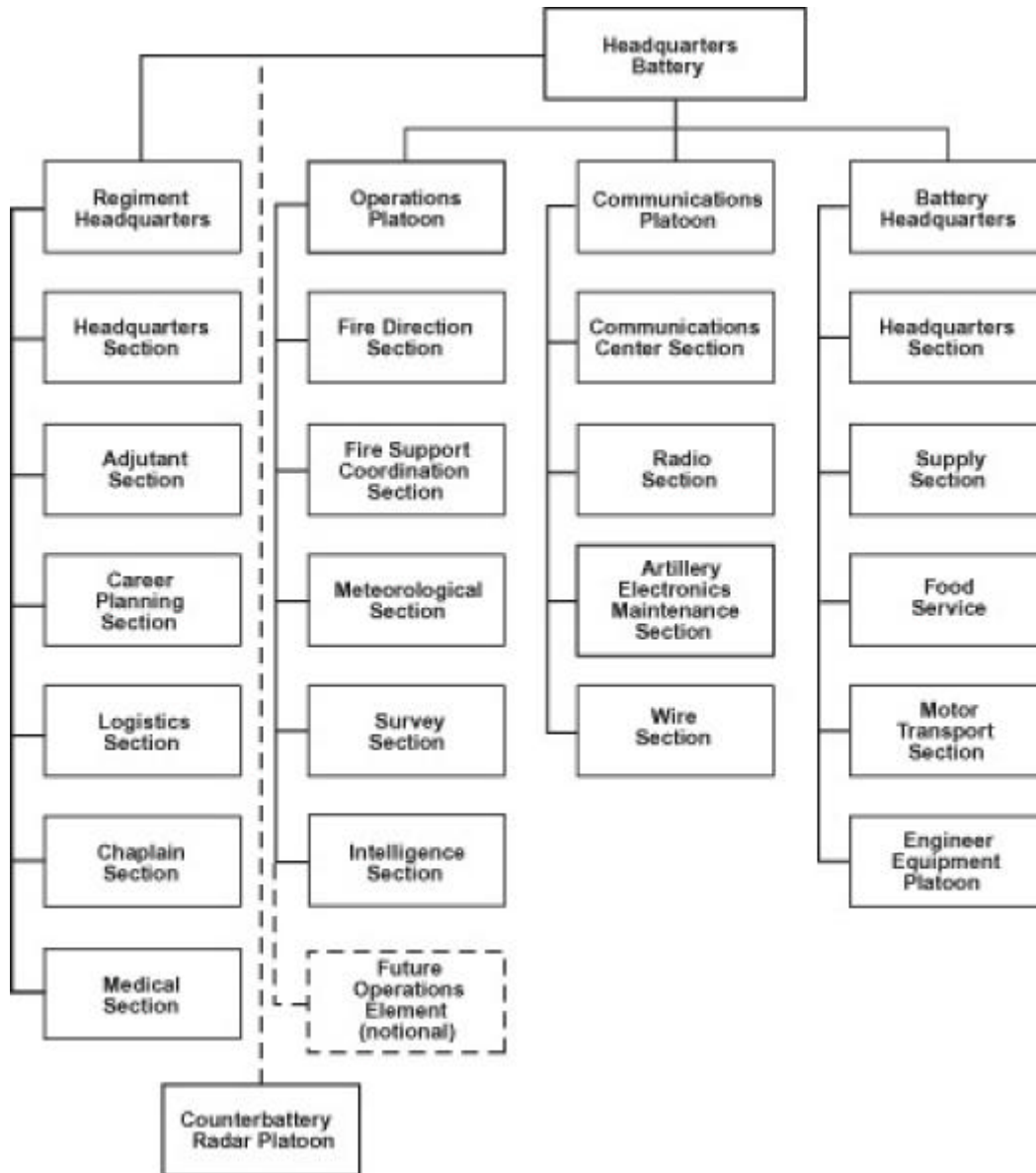

Figure 2-2. Headquarters Battery, Artillery Regiment.

with personnel and/or equipment augmentation, may be used as the alternate division CP for a limited period.

Combat Service Support Capabilities

The CSS capability of the regiment is the sum of the capabilities of the regiment headquarters battery and its battalions.

Maintenance

Maintenance is a continual, concentrated effort by all personnel in an artillery unit on a wide spectrum of equipment. Artillery battalions perform organizational maintenance on all equipment except fire control. The regiment performs intermediate maintenance (field) on electronics systems within the command and provides maintenance contact teams (MCTs) to support subordinate units. Intermediate field maintenance

exceeding the capability of the regiment is obtained from maintenance support teams (MSTs) or maintenance facilities of the force service support group (FSSG).

Supply

The regiment headquarters battery and each battalion perform all supply functions to some degree. Particular emphasis is on Class I, III, V, and IX supply. External supply support is obtained from the FSSG. When artillery is attached to another unit, artillery may obtain supplies from the unit to which attached within that unit's capability.

Transportation

Artillery units can move their personnel, equipment, and limited supplies using organic assets. External support may be required to supplement such tasks as hauling Class V (ammunition) supplies. Artillery units can be transported by landing craft, transport aircraft, and, to a limited extent, by helicopter.

General Engineering

The regiment has significant organic engineering capabilities. Organic equipment includes utilities equipment (3 to 60 kilowatt generators) and earth moving equipment (bulldozers). The regiment engineer equipment platoon also has forklifts and decontamination equipment. The regiment commander distributes engineer assets to support artillery operations. The division combat engineer battalion and the FSSG engineer support battalion provide additional support, as required.

Health Services

Artillery units render limited routine treatment, first aid, and emergency medical care. Each firing battery has corpsmen assigned; battalions and regiments have aid stations. The regiment medical section supports the regiment headquarters and provides technical supervision and coordination of all medical activities within the

regiment. The FSSG provides medical care exceeding the capability of the aid stations and also provides dental care.

Services

Artillery units receive services such as postal, disbursing, law enforcement, legal, graves registration, civil affairs, exchange, and information systems from the FSSG. Control over these services is decentralized. The artillery unit has limited enemy prisoner of war (EPW) and civil internee handling capability consisting of collecting and evacuating personnel to the FSSG. When a qualified interrogator is unavailable, EPWs, foreign nationals, refugees, and repatriates may be questioned by artillery intelligence personnel for information of immediate tactical value.

Messing

Messing capability (preparing and cooking rations) exists at regiment and battalion levels.

Survey and Meteorology

Survey and meteorology (met) data are necessary for accurate artillery fires. Artillery regiments and battalions maintain survey capabilities. The regiment headquarters battery has a met section that provides electronic and visual met data to support artillery operations.

Duties and Responsibilities of Regiment Operations Personnel

Regiment Commander

The regiment commander controls the operations of his/her regiment. He/She also functions as the division artillery officer and division FSC.

As the division artillery officer, the regiment commander advises the division commander and his/her staff. He/She determines the requirements for

artillery support and recommends the organization for combat. The regiment commander is also concerned with artillery ammunition, target acquisition, met, survey, and training. He/She maintains situational awareness of the threat.

As the division FSC, the regiment commander advises the division commander and his/her staff on fire support coordination, including fire support coordination training. He/She is also responsible for the operations of the division FSCC, and has two assistant fire support coordinators (AFSCs).

Assistant Fire Support Coordinator

AFSCs provide artillery representation to the division FSCC. These special staff officers have individual responsibilities and access to the division commander and his/her staff. Their specific duties include, but are not limited to, the following:

- Advise the commander on fire support.
- Coordinate the preparation of estimates of supportability.
- Incorporate the targeting process into fire support planning.
- Provide clearance on requests for fire missions and air strikes.
- Disseminate target information.
- Execute the attack of targets from the targeting process according to attack guidance.

Regiment Operations Officer

In addition to fighting the regiment, duties are—

- Recommend artillery organization for combat.
- Recommend attack guidance.
- Guide the survey, met, and radar efforts of the regiment.
- Develop the artillery estimate of supportability.
- Plan future operations.

Regiment Assistant Operations Officer/Fire Direction Officer/Watch Officer

Two assistant operations officers/fire direction officers (FDOs) are assigned to the regiment. They divide the watch based on operational requirements to permit continuous operations. Duties include, but are not limited to, the following:

- Prepare Tab B (Artillery Fire Plan) to Appendix 19 (Fire Support) to Annex C (Operations) of the division operation order (OPORD).
- Develop and execute the artillery execution matrix.
- Coordinate plans and positioning with maneuver units.
- Supervise all COC functions.
- Perform tactical fire direction.
- Execute current operations.
- Maintain the plans map.
- Brief the commanding officer (CO), S-3, oncoming watch officers, and others using the watch officer's checklist.

Target Information Officer

The regiment target information officer is a special staff officer responsible for all targeting matters. He/She assists the regiment commander in his/her duties as the division FSC on intelligence preparation of the battlespace (IPB) and developing targeting products used by the division FSCC. Further responsibilities include the following:

- Produce high-value target (HVT) list, target selection standards, high pay-off target (HPT) list, and the attack guidance matrix.
- Coordinate with the G-2 and target intelligence officer (TIO) during the execution of the intelligence collection process to synchronize target acquisition agencies (radar, unmanned aerial vehicle (UAV), etc.).
- Ensure the identification, dissemination, and engagement of targets to support the maneuver commander.

- Report to higher and subordinate elements battle damage assessment (BDA) and munitions effectiveness.

Fires Tactical Systems Officer

The regiment fire tactical systems officer (FTSO) is responsible for tactical and technical information flow in a digital environment. He/She should have detailed knowledge of all fire support tactical systems (AFATDS, interim fire support automated system [IFSAS], tactical combat operations [TCO], theater battle management core system [TBMCS], etc.). He/She advises and recommends to the commander how to use these tactical data systems. Duties include, but are not limited to, the following:

- Coordinate with the division target information office on producing target selection standards, attack guidance matrix, and HPT list.
- Assist the S-3 in developing the Artillery Fire Plan based on information from the target information officer.
- Assist the division FSCC with producing Tab E (Fire Support Communications/Marine Corps Fire Support System [MCFSS] Plan) of Appendix 19, Annex C.
- Develop criteria to implement targeting products in digital systems.
- Ensure dissemination of fire support information to appropriate agencies.

Regiment Operations Chief

The regiment operations chief is the principal assistant to the operations officer. Duties include, but are not limited to, the following:

- Assist the operations officer in planning.
- Coordinate survey, met, and radar support.
- Coordinate and provide information for the Fire Support Communications/MCFSS Plan of the division operation order to the division fire support/liaison chief with the division FSCC.

Regiment Assistant Operations Chief/Watch Chief

The regiment assistant operations chief/watch chief is the principal assistant to the FDO/watch officer. Specific duties include, but are not limited to, the following:

- Supervise FDC enlisted personnel.
- Ensure required reports are received and processed.
- Ensure the situation map (SITMAP) and all status boards are current and accurate.
- Ensure the journal and missions fire log are properly maintained.

Tactical Precepts

The following artillery precepts will be followed when supporting operations:

- Mass fire on deep targets to prevent reinforcement of threat positions.
- Weight the main attack in the offense/focus of effort in the defense. Position artillery well forward to exploit range capability and facilitate exploitation.
- Provide counterfire. Employ air assets to conduct counterfire when feasible (quick-fire channel with radar).
- Configure the regiment main COC to move the forward (FWD) COC and maintain independent operations for a limited time. Position the main COC 2 to 4 kilometers forward of the division main COC or as dictated by terrain and tactical considerations.

Tactical Planning Considerations

The tactics, techniques, and procedures in this chapter apply in a digitized environment. Digital tactical and technical fire direction and command, control, and communications (C3) should be emphasized while maintaining a voice backup capability.

- Expect and anticipate execution of hasty and informal fire plans.
- Plan and provide for long range communications through retransmission sites and relay stations.
- Decentralize met support.
- Collocate nuclear, biological, and chemical (NBC) control center operations with the regiment main COC.
- Maintain integrity of prescribed mobile loads of ammunition for rapid movement in the exploitation phase of the offensive.
- Disseminate universal time by using the precision lightweight global positioning system receiver (PLGR) time feature or via shortwave radio tones on the 5, 10, 15, and 20 megahertz high frequency (HF) bands.

SECTION II. COMMAND AND CONTROL AGENCIES

Fire Support Coordination Center

An FSCC exists at each echelon of the GCE from division to battalion levels. The FSC organizes and supervises the FSCC under the staff cognizance of the G-3/S-3. The number of personnel and amount of equipment vary with the level of command and responsibility, the size and complexity of the forces involved, the degree of planning and coordination required, and the desires of the commander.

Regiment Combat Operations Center

Throughout this publication, COC is used as the generic command cell. It is important to understand that the only difference between a COC and CP is the presence of the commander. See figure 2-3.

Main Combat Operations Center

The main COC provides C2 for the regiment, conducts liaison with adjacent units, and receives direction from higher headquarters. The main COC command group normally consists of the following:

- S-1 representative.
- S-2.

- S-3 or S-3A.
- S-4 representative.
- Regiment communications officer or assistant communications officer.
- Regiment survey chief.
- CBR officer.
- Liaison officers as assigned.
- Regiment met officer.
- Regiment NBC defense officer.
- Headquarters battery support elements.

Forward Combat Operations Center

The FWD COC is highly mobile, yet can be task-organized for self-sustainment and specific missions. It is activated for displacement of the main COC or to weight a particular zone within the battle area to provide fluid C2 during rapid maneuver scenarios. See figure 2-4 on page 2-8. The FWD COC command group normally consists of the following:

- Regiment commander.
- S-2 representative.
- S-3 or S-3A.
- S-4 representative, if necessary.
- Regiment communications officer or assistant communications officer.
- Regiment survey officer, if necessary.
- Liaison officers as assigned.

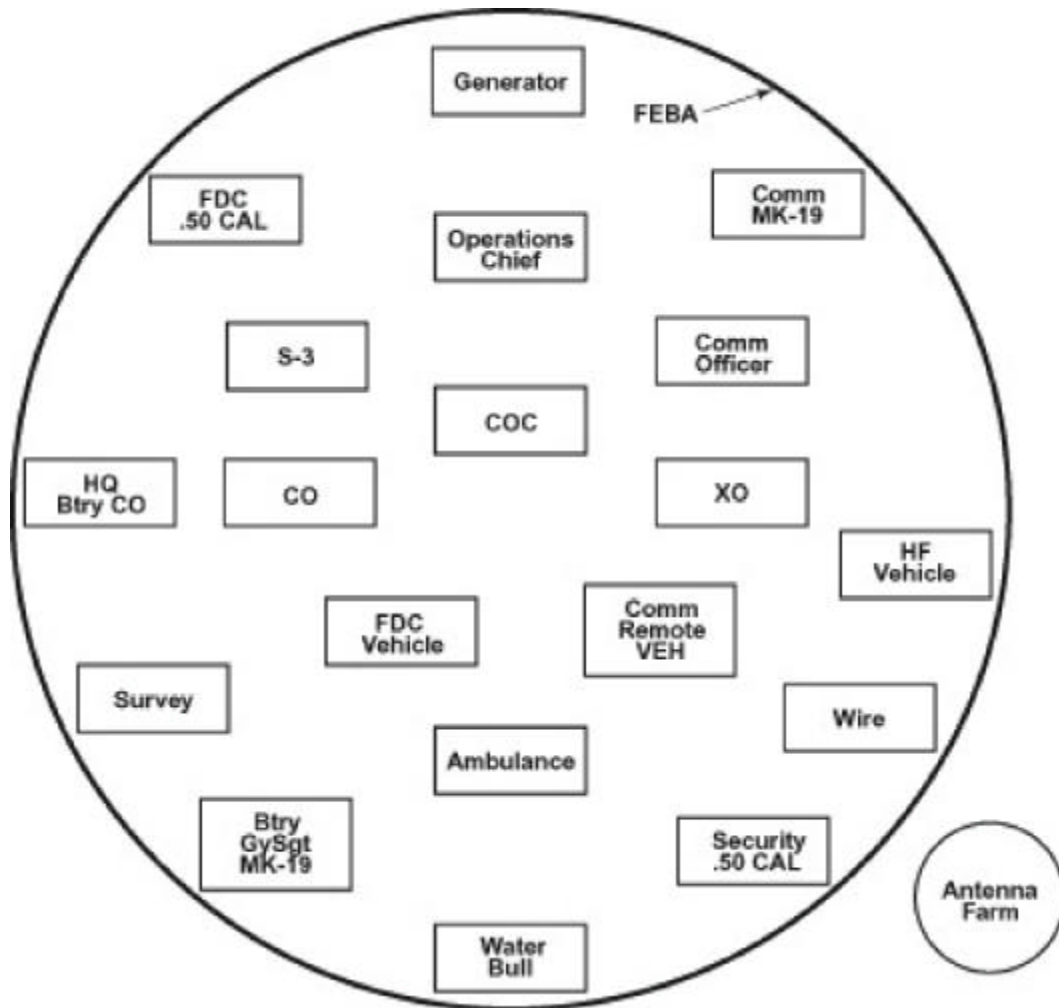

Figure 2-3. Example Regiment COC Site Layout.

- NBC defense representative.
- Headquarters battery commander (occupies main COC once established).

Administrative and Logistics Operation Center

The administrative and logistics operation center (ALOC) is composed of elements from headquarters battery and representatives of subordinate units to provide administrative, medical, messing, and maintenance facilities. The ALOC possesses communications to C2 the logistics mission of the regiment. The ALOC is located in the rear of the

regiment operating area, near a main supply route (MSR), and in a position to provide rapid logistical support and effectively coordinate operations with combat service support elements (CSSEs).

Alternate Division Command Post

The regiment main COC is the designated alternate division CP when severe degradation or catastrophic loss of C3 occurs within the division CP. This alternate CP provides short term C3 to the division. Ideally, the alternate division CP will dissolve within 36 hours and the division main COC/FSCC will reconstitute. The capability

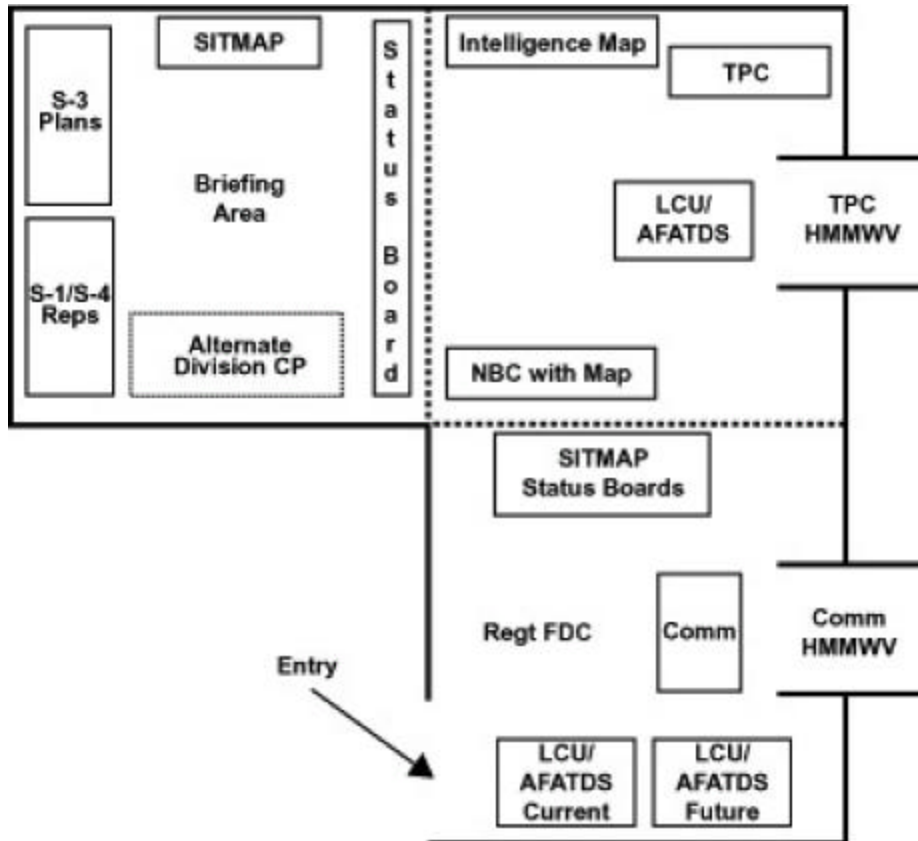

Figure 2-4. Example FDC/COC.

exists with normal succession of command to function for longer periods if necessary.

Alternate Regiment Combat Operations Center

An alternate regiment COC will be designated to provide continuity of command when the regiment COC sustains significant degradation in C3 capability. Operation plans and orders will designate the alternate regiment COC. This is normally a GS battalion; however, all battalions must be prepared to serve as the alternate regiment COC.

Continuity of Operations

The regiment main COC is responsible for C2 of the regiment and must be prepared to serve as the

alternate division CP when severe degradation or catastrophic loss of C3 occurs within the division CP. Each battalion FDC must be prepared to tactically control the fires of the regiment. They must also be able to serve as the alternate regiment COC simultaneously with tactically controlling fires of the battalion, should the regiment COC sustain significant degradation in C3 capability or while it serves as the alternate division CP.

Alternate Division Command Post

When activated, the regiment assumes responsibilities as the alternate division CP. Simultaneously, the regiment FWD COC prepares to assume C2 of the artillery regiment. The regiment FWD COC maintains C3 with existing personnel, facilities, and equipment. The alternate division CP monitors the division tactical situation to exercise control of

the division if control is passed. The alternate division CP provides a COC and FSCC capability. C3 will continually be enhanced as remaining division assets are reassembled and operations reconstituted. C3 will be passed back to the division main as quickly as possible and generally upon obtaining a capability equal to that of the alternate division CP. Operations will be generally conducted in three phases:

- **Phase I**—the regiment assumes control of division operations.
- **Phase II**—surviving members of the division staff arrive at the alternate division CP and receive briefs and updates from the regiment commander and staff. The division staff begins to reconstitute operations in expeditionary facilities provided by the regiment (tents, maps, status charts, double-remoted communications nets, etc.).
- **Phase III**—the division staff assumes C3 internally and the FWD regiment COC assumes C2 from the main COC (either internally or externally).

Security and Administration

The headquarters commandant (headquarters battery commander) of the alternate division CP coordinates local security and administrative requirements with the regiment COC. The regiment provides personnel and communications to establish control for the division when command is transferred.

Personnel

Upon activation, all staff sections will augment the regiment COC to establish C3 of the division while maintaining C2 of the regiment.

Administrative and Logistical Support

The regiment will provide limited administrative and logistical support for the alternate division CP

until headquarters battalion, division can resume these functions.

At a minimum, the regiment will provide the following alternate division CP facilities: tent, power, lights, maps, and remoted communications.

SITMAPs and overlays passed to the division will be in the scale used by division (most commonly 1:100,000).

Assumptions

Due to the limited resources of communications platoon, single-channel radio (SCR) will be the primary means of communications. The direct air support center (DASC) will remain operational or will be established using assets supplied by the supporting Marine aircraft wing (MAW). These nets will include—

- Tactical Air Request/Helicopter Request HF.
- Tactical Air Direction 1 ultrahigh frequency (UHF).
- Tactical Air Direction 2 UHF.
- Tactical Air Traffic Control UHF
- Tactical Air Traffic Control HF.

Alternate Regiment Combat Operations Center

The alternate CP will assume control when—

- Directed by the regiment commander.
- The regiment headquarters cannot be contacted by any communication means from any subordinate battalion for a specified period of time.

Actions upon Assumption of Control

Notification of assumption of regiment control by a battalion will be made to division headquarters, all battalions within the regiment, adjacent artillery headquarters, and any attached unit headquarters. Any assistance from other units will be requested at this time.

Regiment Planning Cell

The regiment planning cell will be established as required by the artillery regiment. The senior Marine from the survey information center (SIC) is responsible for the establishment, operation, and displacement of the planning cell. The planning cell will focus on future operations, requiring close and continuous operation with the division CP and FSCC.

Regiment Fire Direction Center

The regiment FDC is composed of personnel from the operations platoon. The typical regiment FDC will have watch sections consisting of the FDO/watch officer, operations chief, and fire control Marine. The regiment communications platoon provides a communications watch supervisor and sufficient personnel to staff the radio terminals in the FDC. Functions of the regiment FDC during operations include targeting and counter-fire activities, tactical fire direction, and movement and positioning of units. The FDC, target processing center (TPC), intelligence section, and other headquarters sections compose the main echelon COC. Appendix C is a checklist for passage of C2 watch officers to aid them in their duties.

Fire Direction Objectives

Fire direction involves tactical decisions and computing technical firing data. Fire direction objectives are as follows:

- Continuous, accurate, and timely fire support under all conditions of weather, visibility, and terrain.
- Flexibility to engage targets over a wide area.
- Prompt massing of fires of all available units in any area within range.
- Rapid delivery of fires within the zone of the supported unit.
- Control of artillery through orders, policies, priorities, and by means of adequate liaison and communications.

- Implementation of safety measures.
- Gaining/exchanging target information.
- Coordination of subordinate unit's fires and integration of the artillery fire plan with other supporting arms.

Organization

The FDC is organized to meet the requirements and conditions existing at the artillery headquarters. Its configuration may vary with the mode of operation and tactical situation; e.g., degree of permanence. FDCs may be established in tents, buildings or vehicles. In the typical regiment and battalion FDC, operations and intelligence sections are collocated. The arrangement must allow for the rapid determination of fire direction (tactical or technical) and exchange of information between personnel. Maps and charts should be positioned to facilitate sharing of information. Radios must be positioned to allow for monitoring and the rapid access by commanders and staffs. Space must be allowed for liaison officers (LNOs) or representatives of attached elements; e.g., TPC. Only essential personnel should be in the FDC. In the regiment and battalion FDCs, a watch officer/FDO supervises the operation of the FDC, under the cognizance of the S-3. The S-3 positions himself/herself where he/she can best perform his/her duties. In the battery FDC, the battery FDO supervises the operations of the FDC.

Tactical Fire Direction

The regiment FDC exercises tactical fire direction of organic artillery battalions and attached artillery units; e.g., attached multiple launch rocket system (MLRS). It exercises tactical fire direction to the degree consistent with the communications capability, positioning of units, and range capability. The regiment FDC receives fire missions from several sources, including the division FSCC and its own observers; e.g., survey, weapons-locating radars, etc. It also receives requests for reinforcing fires from artillery battalions. The regiment assigns fire missions to a battalion or attached unit. To avoid

diverting DS artillery from its primary mission, artillery units in GS are normally tasked first. The regiment FDC directs the massing of artillery battalions on targets worthy of such attack.

Targeting and Counterfire Activities

The regiment FDC works closely with the division FSCC and division G-2 section to manage targeting. The artillery regiment commander, as division FSC, ensures the coordination of all targeting and counterfire activities. The regiment S-3 and S-2 interface with their counterparts in the artillery battalions and with the CBR platoon commander for targeting. Specific emphasis is on counterfire targets.

Movement and Positioning

The regiment FDC monitors the location of artillery battalions, attached artillery units, and weapons-locating radars.

The artillery battalion commander in DS will position his/her batteries to best support the supported unit. He/She keeps the regiment FDC informed on the positions of his/her units. The DS artillery commander keeps the regiment FDC informed of all displacements directed by the DS battalion to include the reinforcing artillery battalion. When required, the artillery regiment commander or S-3 may assign a PA to a DS or reinforcing battalion. This is normally done for a future mission assignment. Such assignment must not preclude the battalion from accomplishing its current mission.

The regiment commander or S-3 directs the positioning of GS and GS-R units and radars operating under regiment control. These units are positioned to ensure adequate coverage of the division, provide mutual support, support the division as a whole, and facilitate future mission assignments. The positions of DS and R units are

considered when positioning GS and GS-R units within the division FSCC.

Clearance to Fire

Calls for Fire

The FDC is responsible for ensuring clearance to fire has been received for artillery fires. Artillery fires on targets beyond an established coordinated fire line (CFL), by definition, can be delivered without clearance from the unit in whose zone of action the fires will impact. Fires on targets short of the CFL, however, require some method of clearance. Based on the commander's rules of engagement (ROE), the procedure for clearing these calls for fire will be specified in operation orders or unit SOPs as positive clearance or passive clearance. Artillery COF nets are monitored by artillery LNOs in battalion FSCCs. After coordinating the monitored call for fire as discussed in MCWP 3-16, the LNO (on behalf of the FSC) approves or denies the request for clearance to engage the target and the use of artillery on the target (type and volume of fire requested). Under positive clearance procedures, each call for fire on targets short of the CFL must be specifically cleared by a voice or digital transmission from the FSCC of the unit in whose zone of action the fires will impact. This may require FSCCs monitoring calls for fire from its observers to seek clearance from other FSCCs. Under passive clearance procedures, the FSCC monitors the call for fire transmission. It remains silent if the fire mission is cleared (silence is consent). It interjects by voice or digital transmission if the fire mission is not cleared or if more time is required to clear the fire mission; e.g., with another FSCC. For further discussion, see MCWP 3-16.

Adjustments

Cumulative corrections in the adjustment phase of a fire mission must be followed for possible interference or danger to friendly units.

Fires beyond the Fire Support Coordination Line

Units firing on targets beyond the fire support coordination line (FSCL) must inform all other affected units in sufficient time to allow reaction to avoid friendly casualties and unnecessary duplication. The MAGTF FFCC or senior FSCC will establish procedures for exchanging this information.

Other Clearance

Based on the maneuver commander's guidance, clearance may have to be obtained before use of those munitions that can cause danger or affect operations of the supported or other units. Examples are smoke, illumination, improved conventional munitions (ICM), and family of scatterable mines (FASCAM). See MCWP 3-16.

Request for Reinforcing Fires

The request for reinforcing fires form (see figure 2-5) is designed to assist FDCs in recording, properly formatting, and transmitting technical fire direction information. It uses procedures and doctrinal formats found in MCWP 3-16.4, *Tactics, Techniques, and Procedures for Field Artillery Manual Cannon Gunnery*. The following procedures will be used with the request for reinforcing fires form.

Mass Fire Collective Call Sign

Each regiment will develop a collective call sign to be used on all missions directed to or initiated by the regiment COC.

Readback

Readback of all tactical fire direction information will be performed by the designated readback station. All other units will acknowledge receipt of the fire order in battalion numerical sequence subsequent to the readback.

Reporting Ready and Time of Flight

Firing units will only report "Ready" and "Time of Flight" on fire missions where the time of opening

fire is designated as "At My Command," and short countdown time on targets (TOTs). These reports are unnecessary for time interval TOTs (firing units will only report to the controlling element when they are unable to meet the TOT).

Reporting

During a mass fire mission, all required reports—shot, rounds complete, etc.—will be sent to the controlling element.

Reporting During Schedule of Fires

When a schedule of fires is initiated, firing units will report "Shot" at the beginning of the schedule of fires and "Rounds Complete" at the end of the schedule of fires. When a firing unit fails to meet the scheduled ammunition expenditure for individual targets within a schedule, it will be reported immediately to the controlling element. This will afford the agency initiating the schedule to decide if a repeat of the mission or attack by another fire support means is required to meet the commander's attack guidance. Also, if a firing unit anticipates missing a specific time line in the schedule of fires, it will report this to higher headquarters immediately. This will afford higher headquarters the opportunity to deconflict with the establishing agency.

Forms, Records, and Charts

The FDC must maintain the necessary forms, records, and charts to conduct fire direction. MCWP 3-16.4 discusses the requirements for technical fire direction. For tactical fire direction, some of the requirements are discussed in the following paragraphs.

Situation Map

The SITMAP is actively sought and maintained by FDCs for adequate fire support and safety to friendly forces.

_____ this is _____ request reinforcing fires "over"

Warning order
 Type of mission: now adjusting/FFE
 Size of element to FFE (call sign) "over"

Target location
 Target number _____
 Grid _____ Altitude _____ Length _____ Width _____ Altitude _____
 Altitude (omit if adjust fire) _____ "over"

Target description _____
 Method of engagement _____
 Method of fire and control _____ "over"

Note: This is transmitted by requesting unit.

FIRE ORDER

_____ this is _____ "over"

Warning order
 Now adjusting _____ Fire for effect _____
 Unit to FFE _____/adjusting unit _____

Target number _____
 Target location _____
 Grid _____ Altitude (omit if adjust fire) _____

Distribution* _____
 Projectile* _____
 Ammunition lot and charge* _____
 Fuze* _____
 Number of rounds* _____
 Range spread/lateral spread/zone fire/sweep fire/high angle _____
 Time of opening fire
 When ready _____ at my command _____ TOT _____ TOT at _____
 TOT _____ minutes from my mark...

Controlling unit _____
 *May be standardized.
 Note: This is developed and transmitted by higher headquarters.

MTO: Unit to FFE _____
 Changes from calls for fire _____
 Number of rounds in effect _____
 Target number _____
 Cleared by _____ at _____
 Target number _____ DTG fired _____

Note: This is developed and transmitted by higher headquarters.

REPLOT DATA

_____ this is _____
 Units to FFE _____ adjusting _____

Replot data

Unit	Roger	Ready	TOF	Shot	Rounds Complete	End of Mission
_____	_____	_____	_____	_____	_____	_____
_____	_____	_____	_____	_____	_____	_____
_____	_____	_____	_____	_____	_____	_____

Surveillance

Figure 2-5. Example Request for Reinforcing Fires Form.

The SITMAP shows battery positions, artillery headquarters echelon positions, supported unit headquarters echelons, fire capabilities overlay depicting the range and traverse limits of the firing units, target overlay, and radar capabilities overlay, as required.

The supported unit SITMAP shows the scheme of maneuver overlay, fire support coordinating measure (FSCM) overlay, check points and route overlay, FO positions (firing battery), and maneuver unit positions.

The threat SITMAP is maintained by the intelligence section. Emphasis is on plotting high payoff targets.

S-3 Journal

The S-3 journal is used to record all incidents and messages with an entry describing the action taken, if any. Copies of messages and orders sent and received and records of fire missions should be maintained. At specific intervals, the journal is closed and becomes part of the unit journal maintained by the regiment S-3.

Miscellaneous Forms, Records, and Charts

Examples of these are fire order standards and ammunition and communications status.

Reporting

FDCs exchange reports with each other and their supported units. These reports assist in tactical fire direction and fire support coordination. See appendix D for formats. The artillery, as prescribed in the operation order or SOPs, may submit other reports. Unnecessary reports or reports that duplicate data submitted in other reports should be avoided. Also see MCRP 3-37.2A, *Chemical and Biological Contamination Avoidance*.

Ammunition Report

The ammunition report (AMREP) is used to maintain an accurate ammunition status of firing units. It facilitates ammunition resupply and the

forecasting of consumption rates. The AMREP is submitted frequently enough to allow operational and resupply decisions. The frequency for submission is often specified in unit SOPs or in operation orders. Submit the report to the higher artillery headquarters. The artillery LNO with the supported unit's FSCC is kept abreast of the artillery's ammunition status.

Displacement Report

The displacement report (DISREP) is used to report the displacement of a firing battery or element. The DISREP is submitted when the unit can no longer fire from its present position due to displacement. The report is submitted to the higher artillery headquarters and to the supported unit.

Fire Capabilities Report

The fire capability report (FIRECAP) is used to report the firing status of an artillery battery or element. The report is made when a unit occupies a new firing position and is ready to fire or when a change occurs in the number of weapons available; e.g., a gun out of action due to threat action or mechanical malfunction. The FIRECAP is sent to the higher artillery headquarters and the supported unit.

Command Post Report

The command post report (CPREP) is used to report the time of opening and closing of a headquarters echelon and the location of the new echelon. The report is submitted to the higher artillery headquarters and the supported unit.

Flash Report/Spot Report/Target Report

These reports are submitted after significant incidents such as contact with the threat, incoming fires, receipt of friendly casualties, damage to friendly equipment, findings of significant intelligence value or initiation/completion of tactical operations. The target report (TAREP), used to pass target data, is submitted when a significant target is detected or after the attack

of a significant target or target on the target list. Submit these reports to the higher headquarters and the supported unit.

Radar Report

The radar report is used by the artillery to control and coordinate the use of CBR platoon radars. The CBR platoon and the controlling artillery unit use the report.

Firing Report

The firing report (FIREP) is used to report the firing on a major target. Major targets are normally specified in the operation order or SOP. The report is submitted to the higher artillery headquarters and/or supported unit.

Nuclear, Biological, and Chemical Reports

NBC reports are used to report NBC contamination and conditions as determined by friendly units. They are sent as directed by established SOPs, operation orders or fragmentary orders.

Other Reports

Other reports may be submitted by the artillery as prescribed in the operation order or SOPs. Avoid unnecessary reports or duplicate reports.

Other Functions of the Regiment Fire Direction Center

- Ammunition management.
- Muzzle velocity management.
- Coordinate CBR platoon employment.
- Arrange survey and met support.
- Coordinate electronic warfare (EW) support.
- Coordinate engineer support.
- Interface with supported unit's FSCC on artillery.
- Disseminate FSCMs, attack guidance, and other information received from supported unit.
- Prepare the artillery fire plan.
- Disseminate firing restrictions and safety guidelines.
- Coordinate NBC defense and operations.

SECTION III. REGIMENT SURVEY

Mission

The mission of regiment survey is to provide a common grid over the division area. This includes establishing initial control, densification of existing control, and conversion to common control over stations not in the division network. The survey section normally performs fourth order surveys for massing of fires, delivery of surprise observed fires, delivery of effective unobserved fires, and transmission of target data from one unit to another to aggressively neutralize and destroy threat targets. Establishing a common grid is a command responsibility.

Duties of the Regiment Survey Officer

The regiment survey officer is a member of the regiment special staff. Duties include, but are not limited to, the following:

- Accompany the regiment commander or his/her representative on reconnaissance of the new position.
- Advise the commander of the capabilities and limitations of the survey section.
- Formulate and implement the regiment survey plan.

- Maintain close liaison with the battalion survey officers and coordinate survey operations within the regiment.
- Establish, coordinate, and supervise the activities of the SIC.

Duties of the Survey Chief

The survey chief is the principal assistant to the survey officer. Duties include, but are not limited to, the following:

- Perform, when directed, any or all of the duties of the regiment survey officer.
- Ensure all survey data is correctly derived, transmitted, and filed at the SIC.
- Supervise and train surveyors in conducting operations and maintaining survey equipment.

Duties of the Chief of Party (Conventional and Position and Azimuth Determining System)

- Train his/her survey party.
- Supervise and coordinate field operations of his/her survey team.
- Maintain and be accountable for his/her equipment.

Duties of the Survey Recorder/Computer

- Maintain the required forms for computations of survey.
- Perform independent computations with a survey computer system.
- Maintain the survey section's computer systems.
- Perform chief of party's duties in his/her absence.

Duties of the Instrument Operator

The instrument operator operates and performs preventive maintenance checks and services on the team's survey equipment.

Survey Information Center

The SIC will be established by the regiment survey officer in the regiment COC.

The SIC is organic to the regiment survey section and is the only section authorized to compile, maintain, and issue changes to a trigonometric list pending approval from the CO. The SIC will maintain a file of survey control points (SCPs) applicable to the area of operations (AOs).

The SIC will disseminate survey information to all interested parties of the regiment and division. This information can be in the form of trigonometric lists, SCP listings, survey assistance, computations or points of contact with higher agencies such as the National Imagery and Mapping Agency (NIMA).

The SIC will maintain a combination operation/SITMAP, which will depict, at a minimum—

- Friendly situation.
- SCPs.
- Present and proposed artillery positions, observation posts (OPs), met and radar sites, and other pertinent information.

Regiment Survey Methods

All regiment survey sections will accomplish field work procedures and computations involved in global positioning system (GPS) surveying, traverse, intersection, resection, hasty survey, and astronomic observation techniques in accordance with MCWP 3-16.7. The regiment survey section is the only unit permitted to establish permanent SCPs. See MCWP 3-16.7 for more information on starting control; distance determination; angle measurement; recorder's notes/closure of survey; computations; station marking; and priority of survey.

All station marking will be in accordance with MCWP 3-16.7. If a station must be placed in a roadway, the location will be marked by a nail driven through a piece of colored flagging and a witness stake will be placed near the edge of the road.

Stations will be tagged with the name of the station, order or accuracy, the surveyor's unit, and date of survey.

The regiment is the only unit authorized to select a fourth order station for enclosure in a trigonometric list and to monument it in concrete or other permanent marker.

SCPs are considered public domain and are not to be used as staging areas, rally points, CPs or targets.

FOs may temporarily occupy suitable SCPs to conduct height of burst (HOB)/mean point of impact (MPI) registrations, but must depart the station upon completion. Survey equipment found on top of a station must not be disrupted, due to the possibility that survey operations may be in progress. For priority of survey—

- Establish SCPs for the battalions.
- Extend control to CBR sites.
- Establish declination stations.
- Extend control to met stations.
- Perform target area survey that is outside a battalion's area of responsibility (AOR).
- Assist battalion survey sections and other units (mortars, position location reporting system [PLRS], EW, etc.).

SECTION IV. REGIMENT METEOROLOGY

Mission

Atmospheric conditions affect the accuracy of artillery fires. To increase the possibility of target neutralization from first round fire for effect, and to support the artillery in accomplishing its mission, the met section must provide timely and accurate met messages. This will allow artillery units to correct for all nonstandard weather conditions and ensure effects on target. The mission of the artillery is to provide the following types of electronic met messages.

Computer

Computer met messages are used to apply met corrections to the computer solution of the gunnery problem and for use in the AN/TPQ-36 radar.

Ballistic

Ballistic met messages are used to apply met corrections to the manual solution of the gunnery

problem and the backup computer system-replacement (BUCS-R).

Fallout

Fallout met messages are used by NBC sections to determine the downwind hazards caused by an NBC agent attack.

Target Acquisition

Target acquisition met messages are used to apply met corrections to AN/TPQ-37 CBRs (relative humidity is used by the Q-37 to correct for refraction).

Limited Source Observation

Although these messages provide limited weather conditions for a small portion of the battlefield, they can provide the theater commander an accurate weather picture for the entire AO when combined. This met message is also given to the

NBC defense officer for use in projecting chemical downwind hazard areas.

Duties of the Regiment Meteorology Officer

The met officer is a member of the regiment special staff. He/She is responsible for making recommendations and advising the regiment commander and his/her staff on all artillery met matters. Duties include, but are not limited to, the following:

- Select positions for the met stations.
- Coordinate with adjacent met sections and supported units concerning met schedules.
- Ensure all met data disseminated is verified in accordance with MCWP 3-16.5, *Field Artillery Meteorology*.

Duties of the Regiment Meteorology Chief

The regiment met chief acts as the principal assistant to the met officer and, when directed, performs duties of the met officer. Duties include, but are not limited to, the following:

- Supervise the operation of the met station.
- Direct the emplacement of the met section equipment.

Coordination of Assets

It is the responsibility of the artillery regiment/battalion commander to recommend the position of the met assets assigned to his/her organization. It is the met officer's responsibility to determine the exact location of the met assets. The met team leader will determine the exact location of the met equipment within the met site. In many instances, the met section chief will act in the capacity of the met officer and must be technically qualified to perform those duties.

Meteorological Operations

The regiment met station will be employed where it can best support the artillery regiment. It is possible for met messages to be available from more than one source. When messages from more than one met section are available, the following selection criteria will be used:

- **First Preference**—select the met message from a section within 20 kilometers of the projectile midpoint trajectory and less than 2 hours old.
- **Second Preference**—select the met message from a section within 20 kilometers of the projectile midpoint trajectory and more than 2 hours old. A met message may be considered valid from 1 to 4 hours depending on the time of day and patterned atmospheric conditions.
- **Third Preference**—select the met message from a section within 80 kilometers of the projectile midpoint trajectory and less than 2 hours old.

Meteorological Site Selection

The primary consideration in site selection is the ability of the met section to accomplish its assigned mission. The commander's mission order and his/her intent must be understood and carried out. Before a site is selected, the requirements of the supported unit, types of met support required (electronic/visual), and units requiring the support must be considered.

Tactical Situation

The commander must provide a situation statement prior to selecting a site. The statement must consider both the threat and friendly situations, with particular emphasis on how they relate to the assigned mission. It is critical that the met officer know the friendly scheme of maneuver and the anticipated threat course of action (COA).

Coordination of Assets

Coordination with adjacent units is essential to ensure that multiple flights are not flown when a single flight would suffice if it were disseminated properly. It is the responsibility of the met officer to inform the commander of the necessity for this type of liaison. The met chief should coordinate all liaison activities with adjacent units. When determining met validity, the size of the area that must be covered and the type of terrain are essential data. Consideration must also be made for the operating frequency of the radiosondes to prevent met sections from tracking the wrong radiosonde.

Communications

The site must facilitate the transmission and receipt of communications from the headquarters element and the using unit. In the site selection process, the met team chief must plan for radio or wire, voice and digital communications. The type of met equipment to be used is critical when considering communications. The AN/TMQ-41 meteorological measuring system (MMS) is capable of both digital and voice communication by either wire or radio. When visual met pilot balloon (PIBAL) systems are used, communications are restricted to only voice communications.

Supported Units

Not only must the met sections be able to communicate with the units requiring met support, they must also be positioned where they can provide the most accurate met data to the largest number of units possible. Positioning must be as efficient as possible. A clear and open area is necessary for establishing a met site and emplacing the AN/TMQ-41 MMS. Consideration should also be given to the possibility of signal interference from high powered communication assets. The met station should be located where it can best support the artillery, yet be tactically survivable. Also, the met station must

know the primary direction of fire and the prevailing winds.

Supporting Unit

The met section can only transport a 7-day supply on their vehicle assets. The supporting unit should maintain a 14-day supply on hand for all three met sections.

Measuring Atmospheric Conditions

Met personnel are responsible for measuring, computing, and reporting the current atmospheric conditions as they relate to the artillery. Met sections employ two methods of measuring atmospheric conditions: electronic and visual PIBAL.

The electronic method is the most accurate and the preferred measuring method. The AN/TMQ-41 MMS is the primary means for determining electronic met data. The MMS has the capability for digital interface with the battery computer system (BCS), interim fire support automated system, and AFATDS. The system can digitally communicate via wire and radio. The MMS does not emit signals as it tracks a radiosonde. The MMS also has a remote launch capability, which enables the system to track a radiosonde launched from as far as 20 kilometers from the MMS site. Also, a mobile mode enables the MMS to march order while a flight is still in progress and continues to track it until the MMS vehicle arrives at the next position, at which time the message is disseminated.

Visual met is determining upper air conditions from PIBAL observation. Visual met is an alternative or backup to electronic met. Visual met is the primary method of measuring atmospheric conditions for independently deployed firing batteries when distance and met validity are considerable and electronic means cannot be used.

Requirements and Dissemination of Data

To ensure the best support possible, the following information is required for met support:

- Type of message required.
- Maximum ordinate expected.
- Dates required.
- Delivery times (local standard time).
- Method of delivery to include frequency and call signs.

Mets will be flown as scheduled by the met officer based on guidance from the regiment S-3 and patterned atmospheric conditions for the AO. Additional mets, modifications to the schedule or special requirements should be coordinated with the regiment S-3.

Met messages will normally be transmitted digitally to the COC for redistribution/dissemination to subordinate units or, in the case of a direct

support battalion, directly to the battalion COC. In all cases the best method for transmission will be employed. Met messages will be distributed in accordance with the current SOP for communications or per current operation order.

Battalions with a DS tactical mission requesting met support must coordinate with the regiment S-3 and met officer. Once a met team is attached, the met team chief is responsible to the battalion S-3 for the positioning and the operation of the met station. Logistical support (fuel, local security, communications, and messing) will be provided by the unit being supported. Tactical guidance will be provided by the battalion S-3. The unit supported must provide survey reconnaissance support.

Units receiving a met message will verify its validity in accordance with MCWP 3-16.4. If the validity of the met message is questionable, the unit will contact the regiment FDC, battalion FDC or met team for resolution.

SECTION V. COUNTERBATTERY RADAR PLATOON

Mission

The primary mission of the CBR platoon is to locate threat rocket, mortar, and artillery weapons and process all acquired threat locations in a timely manner for counterfire and intelligence purposes. Secondary missions that can be assigned by the supported artillery unit are adjusting or registering artillery. When a radar is used for a secondary mission, it cannot perform its primary mission.

AN/TPQ-46A Capabilities

The AN/TPQ-46A firefinder radar can determine accurate first round locations of threat

rocket, mortar, and artillery weapons firing either high or low angle from 750 to 24,000 meters. The radar is normally employed to electronically scan a sector of 1600 mils in the hostile mode of operation. However, the radar can search an area of up to 6400 mils by using the extended azimuth function. In this function, the designated search area is divided into 1600-mil sections and the radar automatically searches each sector for the amount of time assigned by the operator. If a sector has not been programmed for search, the antenna may be reprogrammed and operational within 20 seconds. The radar detects, verifies, and tracks projectiles in flight. The radar has two modes of operation: hostile and friendly. See table 2-1.

Table 2-1. Target Acquisition Radar Planning Table.

Characteristics	Weapons-Locating Radars	
	AN/TPQ-46A	AN/TPQ-37
Planning Ranges Artillery and Mortars Rockets	12,000m 24,000m	30,000m 50,000m
Azimuth Search Sector Coverage	1600 mils (6400 in extended azimuth mode)	1600 mils
Accuracy	FFE Accuracy	FFE Accuracy
Traverse	6400 mils	6400 mils
Elevation	15 to 30 mils Screen Crest	5 to 15 mils Screen Crest
Emplacement Time	20 min	30 min
Fording Capability	16 in	30 in
Travel Weight	Trailer 4,400 lbs Shelter 2,780 lbs	Trailer 17,780 lbs Shelter 2,780 lbs
Dimensions (length, width, and height) Trailer	170.75 x 84.5 x 94 in	234.75 x 96 x 134 in
Shelter on 2-1/2 Ton Truck	264.25 x 97.75 x 123.75 in	234.24 x 97.75 x 123.75 in
5-Ton Truck with 60 KW Generator	N/A	323.25 x 96 x 119.75 in
Shelter (alone)	109.25 x 81.5 x 79.75 in	109.25 x 81.5 x 79.75 in
60 KW Generator without Truck	N/A	156 x 86.5 x 63.75 in
Q-37 Antenna and Transceiver Group without Trailer	N/A	163.5 x 96 x 91.25 in
AN/MJQ-25 Generator with Trailer	171.12 x 82 x 98 in	
Air Transport	External CH-47D, UH-60, CH-53E Internal C-130	External CH-47D Internal C-141
Type of Targets	Mortars, Artillery, Rockets	Mortars, Artillery, Rockets
Normal Distance from Forward Line of Troops	3 to 6 km	8 to 12 km

In-flight tracking data determines the hostile weapon location and the predicted impact point. The radar can simultaneously track up to 10 projectiles and store 200 targets in memory while searching for new targets. Special procedures allow for averaging of closely grouped weapons, elimination of repeated weapon locations, and weapon-location height adjustment. Weapon location can be determined to an accuracy of 50 meters. Impact predictions are accurate to approximately 100 meters. The radar sections transmit data digitally or by voice to the TPC and to a firing unit, if assigned.

The radar can register and adjust friendly indirect fire. For this use, firing batteries are linked either digitally by BCS or voice to a radar section. If

voice, the preferred method is wire. Impacts are determined to an accuracy of 50 meters.

AN/TPQ-37 Capabilities

When operating in joint environments, it is likely that employment of AN/TPQ-37 radars will affect Marine Corps operations. The AN/TPQ-37 is optimized to locate longer-range, low-angle, higher velocity weapons such as long range artillery and rockets. However, it will also locate short-range, high-angle, lower velocity weapons complementing the AN/TPQ-46A. The AN/TPQ-37 has a minimum range of 3 kilometers and a maximum range of 50 kilometers. For artillery, the higher

probability of detection is approximately 30 kilometers. Minimum and maximum detection ranges can be established for the AN/TPQ-37 provided they are separated by at least 900 meters (same requirement as the AN/TPQ-46A).

The AN/TPQ-37 sector of search is from 300 mils (minimum) to 1600 mils (maximum). Although the AN/TPQ-37 is not equipped with the extended azimuth search function like the AN/TPQ-46A, the antenna maintains a 6400-mil traverse capability. The antenna may be reprogrammed to search a new sector and operational within 20 seconds. The AN/TPQ-37 can be emplaced and operational within 30 minutes and march-ordered within 15 minutes during daylight hours. Although actual capabilities of this radar are classified, it can determine locations with fire for effect (FFE) accuracy. See table 2-2.

Table 2-2. AN/TPQ-37 CEP Accuracies.

Weapon	CEP	Accuracy (Whichever is Greater)
Mortar	50%	35m or 0.35% of range
Mortar	90%	90m or 0.90% of range
Artillery	50%	35m or 0.35% of range
Artillery	90%	90m or 0.90% of range
Rocket	50%	70m or 0.70% of range
Rocket	90%	175m or 1.0% of range

Radar Team Employment

In MEF operations, the CBR platoon is normally employed as a unit and controlled by the artillery regiment commander. The TPC is established in the artillery regiment main COC or collocated with the FSC at the division COC. The CBR platoon commander works under the cognizance of the regiment S-2. He/She works closely with the regiment S-2 and S-3 to ensure that all CBR assets are optimally used and that all counterfire and intelligence data generated by those assets are processed correctly. If the MEF is operating over a wide area or in rough terrain, it may be necessary to divide the platoon into detachments to provide optimum support. In this situation,

each detachment will be task-organized with control either retained by the artillery regiment commander or passed to designated artillery battalion commanders (either DS or GS). Such decentralization can enhance timely target engagement.

The CBR platoon commander coordinates the employment of radars operating under regiment control. The S-2 and S-3 provide guidance as deduced from the plan of observation. The S-3 designates the areas that will receive radar coverage. Based on this guidance, the CBR platoon commander selects a sector of search and general PA for each radar section. The radar section chief selects the actual site for the radar. The general PA should provide sufficient space for the radar section chief to locate a site to meet technical consideration.

The battalion S-2 coordinates the employment of radars placed under battalion control. The CBR detachment commander recommends the general PA to the battalion S-3. The radar section chief selects the actual radar site. The radar provides targets to the battalion FDC, where the information is acted on and sent to the regiment FDC. If the battalion cannot achieve the desired effects on a target or is unable to engage the target, reinforcing fires are requested. This will usually occur when the battalion is too involved with close support to engage a counterfire target. The regiment provides guidance on positioning, coverage zones, cueing, and frequencies. The regiment can reallocate radar assets across the division front as dictated by the situation.

Offensive Operations

Positioning authority of radar teams remains with the regiment based on division G-2/G-3 guidance and coordination with the maneuver commander. Radar teams may be attached to DS battalions. The following planning considerations apply regardless of radar's tactical mission:

- The regiment will position radars to maximize coverage and reduce zonal overlap.

- DS battalions may be tasked with providing survey support for radars in their zone of fire; however, the AN/TPQ-46A possesses the Modular Azimuth Positioning System (MAPS) for self-survey support.
- DS battalions may be tasked with clearing PAs within their zone of fire.
- DS battalions should establish a link with the radars and their supported unit's zone to facilitate counterbattery fires in their zone of fire.

Defensive Operations

Radar employment will be centralized to the maximum extent. The regiment will position radars to maximize coverage and reduce zonal overlap.

Positioning

Tactically, the radar is positioned to provide coverage of the zone of action of the supported unit and to provide overlap coverage with other radars. Generally, the radar is positioned 3 to 6 kilometers behind the forward line of own troops (FLOT). Radars should be positioned at least 1,000 meters apart and not face each other. Alternate positions are always selected. The CBR section uses two systems to identify positions:

- **Fire Finder Position Analysis System (FFPAS)**—Software used during planning to identify optimal locations for radar positions. The software incorporates digital terrain elevation data (DTED), radar parameters, and threat indirect fire capabilities to maximize hostile weapon detection and radar section survivability.
- **Modular Azimuth Positioning System (MAPS)**—the Q-46A is equipped with its own survey capability that provides for positional and directional control.

The radar site should be flat. The slope of the ground must be less than 120 mils for the radar antenna to be leveled for proper functioning. The optimum radar site will have terrain that gently

slopes downward in the direction of search for a distance of at least 200 meters and then rises sharply to form a screening crest (a hill mass). A screening crest between the radar and the threat will protect the radar from the threat's EW, direct observation, and direct fire. The screening crest should be located within 300 to 1,000 meters of the radar site and in friendly territory. The screening crest must protect the radar site without degrading radar operation. The ideal screening crest angle for the AN/TPQ-46A radar is 15 to 30 mils or less. The radar can function with a screening crest of up to 100 mils, but accuracy and detection decrease as screening crest height increases.

The radar site should provide cover and concealment but the cover should not interfere with visual or electronic line of sight (LOS). Electronic LOS is a straight path from the transmitting antenna to a reflecting object (projectile) or a receiving antenna unobstructed by terrain or other objects. Care must be also taken to ensure that the area in front of the antenna does not absorb or attenuate radar emissions. Reflections will cause multipath errors that produce false targets in the radar's computer. Optimally, the site will be surrounded on three sides with tall vegetation to provide a tunneling effect of radar emissions and to reduce the amount of side lobe radiation escaping from the radar site.

Probability of detecting projectiles is a prime consideration in the positioning of radars. In the hostile fire mode, the radar should be positioned to sight the projectile while it ascends and approaches the radar. The probability of detection varies with the horizontal (aspect) angle formed at the hostile weapon position between the direction of the hostile projectile and the direction of the radar position. In the friendly fire mode, the radar must be able to sight the projectile as it descends and travels away from the radar. The aspect angle for friendly fire is 1000 mils.

The radar must be positioned for good communications to the TPC. If possible, the radar position should be near a firing battery to facilitate survey

and logistical support, and to take advantage of any existing defensive perimeters. The position must be accessible and provide adequate space for dispersion of four high-mobility multipurpose wheeled vehicles (HMMWVs), tents for personnel, generators, remoted antennae, and other equipment.

Cueing

The radar emits a very high powered beam of energy especially vulnerable to detection. To minimize its vulnerability, a system of cueing (external actions or inputs that cause a surveillance or target acquisition device to turn on and search a suspect area) must be established for the radar to radiate appropriately in hostile and friendly modes. The CBR platoon commander and S-2 coordinate cueing schedules and instructions based on all intelligence information and the commander's guidance. Cueing instructions will vary with the threat, terrain, and mode of operation. Alternate cueing methods should be planned.

In the hostile mode, the radar is oriented and activated on a suspected weapons location as determined by information and intelligence sources. The radar is cued only when threat indirect fire weapons are active. FOs, OPs, and air crews are sources that can cue radars. The radar can radiate for 15 minutes or more without being located by threat ground-based EW *if optimum conditions are met*. These conditions are a minimum search sector, screening crest, and a tunneling effect created by vegetation. If the site has a screening crest but no vegetation for a tunneling effect, radiation must be limited to 8 minutes. If a screening crest is either not available or inadequate, radiation time must be limited to 2 minutes. If the radar radiates for more than 2 minutes, then it must displace immediately to prevent detection.

In the friendly mode, the operator will initiate radiating when the firing unit announces "Shot" and will cease radiating when the radar console

signals "Display next location," or 15 seconds after the firing unit announces "Splash," whichever occurs first.

Regardless of the merits of the radar site or threat EW capability, the EW threat, as well as friendly EW missions conducted, must be constantly evaluated and updated for maximum radar efficiency and survivability. Radiating times of over 2 minutes should be carefully considered before implementation.

Zone Management

The radar employment officer will establish radar search fans based on guidance from the G-2/G-3 and S-2/S-3. He/She will establish common sensor boundaries (CSBs) to reduce multiple target generation. For planning purposes, the CSB will be established at the maximum range of the AN/TPQ-46A coverage that will become the minimum search range for the AN/TPQ-37. Measures should be taken to provide a specific area of overlap based on the tactical situation.

The radar officer will establish call for fire zones (CFFZs), critical friendly zones (CFZs), artillery target intelligence zones (ATIZs) and censor zones (CZs) based on guidance from the G-2/G-3 and S-2/S-3.

- **CFFZ**—An area in threat territory that the maneuver commander considers extremely important to neutralize fires from immediate counterfire.
- **CFZ**—An area where friendly units or units that the maneuver commander designates as critical are located.
- **ATIZ**—An area in threat territory that the maneuver commander wants to monitor closely. Weapon locations in this zone will be reported immediately. Their priority is exceeded only by targets in a critical friendly zone or a CFFZ.
- **CZ**—An area from which the commander wishes to ignore all target detections. CZs must

be used judiciously, since the computer does not report a round originating from a CZ to the operator. A CZ may be used to ignore a friendly artillery position that, because of its aspect angle to the radar, could be detected as threat artillery. This situation could occur when an uneven FLOT exists or when friendly units are in threat territory.

Command and Control

The CBR platoon is employed as a unit or task-organized detachments for responsiveness. Depending on the situation, radars can be centrally controlled by the artillery regiment and the CBR platoon assigned a GS mission.

Some radar sections can be attached to or placed under the operational control of a battalion when the situation dictates. Attachment is favorable for logistics or survey reasons, for widely-separated operations, and for the initial phases of an expeditionary assault or expeditionary landing. A detachment normally contains one to three radar sections, a TPC, and support personnel and equipment, i.e., maintenance, service, and survey support. The detachment commander, normally the radar employment chief or a designated individual, serves as a special staff officer to the supported artillery unit's commander. The supported artillery commander controls the detachment through the detachment commander.

Counterfire Headquarters

See chapter 7.

Target Processing Center Employment

TPC is a detachment of the CBR platoon. It aids in processing all counterfire related targets and is a liaison between the supported unit and the radars. The TPC operates in accordance with the decide,

detect, deliver, and assess (D3A) methodology outlined in MCWP 3-16A. Usually, the TPC will be located with the division FSCC to take advantage of readily available intelligence to clear counterfires, and ready access to the division air officer to request aircraft for attack of counterfire targets. The TPC can move by echelon with the division main CP and the division FWD CP. The TPC may also be located at the regiment COC. Close coordination with the division G-2, G-3 and FSCC is required in this situation.

Integration

When an artillery organization is being supported by the CBR platoon, it is critical for the TPC to be fully integrated into that unit's COC. To effectively function, the TPC should be located near the S-2 and close enough to the S-3 to exchange information quickly. The TPC must route all counterfire and intelligence data obtained by the radar through the S-2 for collation and analysis, prior to it being passed to the S-3. The TPC must keep the S-3 informed of all relevant information pertaining to the CBR platoon, such as when the radars are moving, where the radars are moving to, the status of friendly fire missions, and the operational status of the radars. The S-2 and S-3 must keep the TPC informed of changes to threat and friendly situations, anticipated movements, and other information that could be important to the effective employment of the CBR assets. It is important for the TPC to be included in the FWD and main command groups for constant communication between the supported units and the radars. The CBR platoon/detachment commander and the TPC chief must maintain close liaison with the supported communications officer so he/she is aware of the communications requirements of the TPC, and that TPC radio and communications equipment is incorporated into the communications plan.

Target Production

Target production by the TPC varies from simple to complex and is based on commander's intent

and commander's criteria. In its simplest form, target production is the mere passing of target data acquired from a reliable source to the fire control element for prosecution. Complex target production involves the collation of data from one or more sources for analysis so a decision can be determined to fire at the target or to file the target until more information can be accumulated.

Target Selection Standards

Although targeting data is collected continuously, targets will be produced according to the commander's criteria. This set of guidelines will determine the difference between incoming data that will be collated for future use, and incoming data that will generate an immediate fire mission.

Target Production Map

The TPC maintains a target production map as an aid for producing valid targets and for displaying required information for intelligence purposes. The target production map consists of a map of the AOs with four overlays.

- **Friendly situation overlay**—maintains the positions and activities of all friendly units in the AOs.
- **Geometry/control features overlay**—contains all FSCMs, battlefield geometry, and radar search zones (i.e., call for fire, critical friendly, artillery target intelligence (ATI), sensor).
- **Radar overlay**—contains current radar locations and sectors of search; i.e., radar fans.
- **Target/target indicator overlay**—displays threat activity and target intelligence provided by all target acquisition assets.

Information Flow

Information enters the TPC via several communication nodes. Information processing and distribution within the TPC depends on the type of

data received. Targets received from radars are processed rapidly and forwarded to the G-2. Data considered as a target indicator or data that needs to be collated for future use is plotted and stored until the collated data is sufficient to upgrade a target indicator to target status.

The division intelligence net and digital voice secure telephone (DVST) are the primary means of communication between the G-2 and regiment S-2. The local area network (LAN), facsimile (FAX) machine, and couriers should be used to send pertinent traffic to the G-2.

Hostile weapons locations enter the TPC from CBR communication nodes. When a threat weapon location is transmitted from the radar to the TPC, the following sequence of events will occur:

- The TPC computer operator enters the data sent from the radar into the target file. All information sent by the radar is written in the target log.
- Once the computer operator has compiled all of the data for a particular target location, he/she immediately passes the printout to the S-2 and the plotter. The plotter plots the hostile weapon location on the target and target indicator overlays of the target production map.
- The S-2 determines if the target should be assigned a high priority for counterfire purposes (based on the guidance of the maneuver commander) or be targeted as intelligence information. The S-2 should use the impact predict location and the threat weapon location to assist in assigning priorities to the target. Once the S-2 determines the priority, he/she either passes the printout back to the TPC for collation or presents the information to the S-3 with recommendations. If the target is to be fired on, the target is transmitted to the S-3 computer operator from the TPC.

- Once action has been taken on a target or target indicator by the S-3, that information flows back to the TPC for file management.
- A significant amount of target traffic enters the COC via the FDC. Reports from battalion S-2s and FOs arrive over the regiment intelligence or FDC nets.

Battle Damage Assessment

BDA is a critical step in the targeting process. BDA reports from FOs are critical since a target may still present a threat after it has been fired upon. BDA received by DS artillery battalions should be sent to higher headquarters via the supported infantry regiment. The artillery regiment S-2 should report BDA of GS artillery fire missions and regiment mass missions to higher headquarters/supported maneuver commanders.

The TPC must coordinate with the S-3 on the commander’s attack guidance matrix. See figure 2-6. Highest priority targets must be brought to the FDC’s attention immediately.

Target selection standards information must be considered when making a confirmed/suspected target determination. Targets are carefully analyzed to prevent firing on dummy targets and old positions. Considerations to be examined include the following:

- Is the threat using deception measures?
- How effective are the threat’s deception measures?
- What are the threat’s artillery tactics?

Quickfire Operations

Quickfire is a tactic involving CBR and a fire support asset to destroy threat artillery. First, the target is located by primarily using the CBR. Once it is determined that the target cannot be eliminated by friendly artillery, it is handed over to another fire support asset for attack. The alternate method is to pass the target information to the division FSCC. The division FSCC then assigns the target to a fire support asset for attack.

HPT	WHEN	HOW	EFFECT	REMARKS
Command OPs	P	Arty	N	Plan in initial preparation
RSTA and OPs	P	Arty	N	Plan in initial preparation
2S1 and 2S3	I	CAS (fixed)	N	Plan in initial preparation
2S6, SA-9, SA-13	P	Arty	S	SEAD for CAS
Regt CP	A	EW/Arty	EW/N	Coordinate with electronic attack prior to neutralizing
Reserve Bn	P	CAS (fixed)	D	Intent to attack reserve bn in engagement area Hot
LEGEND: A = AS ACQUIRED D = DESTROY EW = JAMMING OR OTHER OFFENSIVE EW I = IMMEDIATE N = NEUTRALIZE P = PLANNED S = SUPPRESS				

Figure 2-6. Attack Guidance Matrix.

CHAPTER 3

MOVEMENT AND POSITIONING OF THE REGIMENT

General

The artillery commander positions his/her unit to render effective support to maneuver units and enhance survivability. Artillery units conduct movement and positioning by a procedure called reconnaissance, selection, and occupation of position (RSOP). The purpose of RSOP is to assist the rapid and orderly movement of the artillery from a PA, assembly area or a march column into a position from where it can deliver the fire support required to accomplish its mission. See MCWP 3-16.3 for additional information.

Reconnaissance Methods

Reconnaissance is the continuous examination of terrain to determine its suitability for use in accomplishing the mission. Routes and positions for cannons, support installations, and OPs are reconnoitered. There are three methods of reconnaissance—map, air, and ground. The best reconnaissance uses a combination of all three methods.

Map Reconnaissance

Map reconnaissance involves studying and analyzing a map to become familiar with the terrain and determine the location of potential PAs and routes. This method is fast and should be the first step in any reconnaissance. Unsuitable PAs and routes can be eliminated immediately. However, map reconnaissance will not reveal terrain or other features that may have changed, e.g., the existence or utility of a bridge, surface conditions or the presence of friendly or threat forces in positions and along routes. When available, aerial photographs can provide a current, detailed picture of the terrain.

Air Reconnaissance

Air reconnaissance is a quick way to reconnoiter large areas. It is especially useful for checking routes and for getting a general indication of the terrain and PA availability. However, detail of the area may be difficult to determine. From the air, true surface conditions may be undistinguishable or distorted. Also, the ground may appear flatter than in reality. The preferred aircraft for air reconnaissance is the helicopter. Space aboard the aircraft may not allow key staff members to accompany the commander. When planning air reconnaissance, caution must be exercised to preclude the flight plan from compromising the route or positions.

Ground Reconnaissance

Ground is the best method of reconnaissance and is ideally suited for defensive operations. However, it involves time to physically examine the terrain for suitability and risk. Because caution must be exercised to avoid the risk of revealing the position to the threat, ground reconnaissance is best performed during daylight.

Reconnaissance for Movement of the Regiment

Reconnaissance is conducted to prepare for the movement and positioning of the regiment. The regiment is moved and positioned to ensure coverage to the supported force, to weight the main effort, to facilitate future operations, and to enhance artillery operations; e.g., mass fires, counterfire, survivability, communications, and CSS. The regiment commander may conduct limited reconnaissance due to his/her role as division artillery officer and FSC. The regiment commander and/or his/her S-3 direct the movement

and positioning of artillery battalions and other units with GS and GS-R missions and, when required, battalions with DS and R missions. To plan and execute the movement plan, an artillery execution/position matrix may be prepared.

Battalion Position Areas

Positioning of the regiment is accomplished by assigning battalion PAs. Position areas do not constitute a rigid restrictive area for the battalion or its batteries. The PAs should be considered only as guides to be followed as closely as the mission, terrain, and tactical situation permit. Battalion commanders conduct reconnaissance to find PAs to meet their assigned mission requirements and follow the guidance of the regiment commander.

Regiment Headquarters Echelons

The commander positions his/her headquarters' echelons to enhance control and support of his/her battalions and coordination with the division. The commander locates himself/herself where he/she can best obtain the information critical to his/her situational awareness and command the regiment. The COC of the echelon where the commander is located is designated the regiment CP.

The regiment commander selects the general PA for the main echelon, with the S-3's recommendation. Selection is made by map, ground, or air reconnaissance. In consultation with the S-6, the regiment headquarters' battery commander conducts a reconnaissance to determine the specific positions of the main echelon and the location for the COC within that position. During displacement, the main echelon's personnel, vehicles, and equipment moving to and occupying the new position are temporarily designated the FWD echelon until control of operations has been assumed from the main echelon.

The S-3 selects the general position for the rear echelon, with the S-4's recommendation. The S-4 or his/her representative conducts a reconnaissance to determine the specific location of the rear echelon.

Counterbattery Radar Platoon

The CBR platoon commander moves and positions radars operating under the regiment control for coverage of the areas designated by the S-3. The CBR platoon commander conducts reconnaissance for PAs. The radar chief selects the actual site for the radar.

Meteorology Station

The regiment met officer normally conducts reconnaissance and selects the PA for the met station. The met chief selects the actual site. The S-3 makes recommendations for positioning and movement of the station.

Route Reconnaissance

All units conduct route reconnaissance continuously. Route reconnaissance facilitates the movement and CSS of artillery units. This is essential in certain types of environments; e.g., mountains, jungles, and arctic areas. Routes are selected to maximize trafficability and minimize detection and attack by the threat. The strength and condition of bridges and the location of obstacles must be determined and routes and lanes marked. Roads may require improvement by engineers. Information about routes is disseminated to all units.

Route Priorities

The regiment S-3 establishes priorities for the use of the MSR. He/She coordinates the movement of artillery units with the division G-3 and G-4 and regiment S-2 and S-4, and issues movement orders.

Selecting the Position (Advance Party Operations)

The headquarters battery advance party typically consists of the battery commander, the regiment S-6, an S-3 representative, a communications vehicle with personnel as designated by the S-6 officer (wire, multichannel, etc.), and security personnel. If the personnel are available, a representative from each section should accompany the advance party. The specific configuration of the advance party is mission and personnel dependent. Therefore, it may change throughout combat operations. Every effort should be made to maintain continuity among advanced party personnel to maintain a high level of proficiency.

Site Selection

The advance party should designate locations for the COC/FDC, radio antennae, vehicle dispersal, and, as applicable, for medical, supply, maintenance, and ammunition. A position should provide suitable cover and concealment. A position in defilade minimizes visual and radar observations by the threat. Heavily wooded areas provide good concealment, but may hamper communications. In open terrain, the main echelon should be well dispersed. The position should be located on defensible terrain and allow mutual protection with other units, if possible. Selecting a new COC location must be conducive to tactical operations as well as C2. The following paragraph provides some considerations and techniques:

- The most important consideration is the ability to communicate with higher and supported units from the new site.
- Potential headquarters battery PAs as designated by the S-3.
- The headquarters battery commander and S-6 conduct a thorough map reconnaissance of potential PAs.

- Routes are selected based on METT-T and information provided by the S-2.
- The headquarters battery commander or S-6 conducts ground reconnaissance of potential PAs.
- Final site selection is based on S-6/headquarters battery commander concurrence and presented to the S-3 for approval.
- Once the site is designated, advance party personnel typically depart 30 to 45 minutes ahead of the FWD COC. This time is adjusted based on the current tactical situation and METT-T.
- The route is verified by advance party and pre-designated checkpoints are reported back to the main COC along with any essential information that could affect the FWD COC's movement.
- A CPREP is transmitted from the COC to the main COC upon displacement from the current position.

Actions Prior to Occupation

The COC site is the first site selected. The rest of the position orients off the projected front of the vehicle.

One technique for orienting all vehicles and cells in the new position is for the FWD COC vehicle to orient on 12 o'clock. All remaining vehicles and cells emplace and orient off this vehicle.

Wire personnel must run wire from the COC to the antenna farm. Antenna farm personnel continue to establish communications. FD and FSC nets are established in the COC. The generator site and pick-up point are selected. The battery commander must select individual vehicle positions based on terrain for the FWD and main COCs.

Organizing the Position

Organizing the position depends on the size of the area, the technique of positioning, the guidance of

the commander and his/her staff, and the requirements for coordination between sections.

Traffic within the position should be held to a minimum and controlled. Vehicles should be stopped at a dismount point and directed to a vehicle dispersal area. Foot traffic should be restricted to prescribed trails or paths. A local telephone should be connected from the dismount area to the switchboard.

The COC (FDC, TPC and intelligence section) should be located in an area outside the normal traffic flow of other activities. The COC should be marked for “authorized entry only.”

The message center should be at the entrance of the position accessible to incoming messengers.

A switchboard should be located to install wire. It should be in a covered area, away from noise and interference, and must be protected from threat attack.

The aid station should be near a road or trail for rapid reception and evacuation of patients.

Sleeping areas should be established by section.

The messing facility must be easily accessible within the position. It should be near a road to facilitate supply.

Occupying the Position

The objective of the occupation phase of RSOP is to prepare to deliver fire. Individual units of the regiment are extremely vulnerable during this phase. Thus, the occupation must be rapid, orderly, and quiet. Occupations are enhanced by a well-established SOP, training, and a well-prepared position.

Actions Upon Arrival of the Forward Combat Operations Center

- A guide is sent to a prearranged pick-up point to guide the FWD COC into position. The

guide should possess a radio tuned to the convoy frequency—typically the battery command net.

- As the FWD COC passes through the pick-up point, the guide will lead the first FWD vehicle to the COC site where it will be placed in position by the S-3 advance party representative.
- Other FWD vehicles will be met at the pick-up point by the headquarters battery commander and communication Marines to guide the remaining vehicles to their respective positions. Precautions must be exercised to prevent a choke-point resulting in a lucrative target for the threat.
- Focus of effort is establishing an operational COC. All personnel must share this understanding and assist in this endeavor.
- The headquarters battery commander completes individual vehicle positioning.

Passage of Command and Control

Once an operational COC has been established, the S-3A or S-3 at the FWD COC will initiate the passage of C2 from the main COC to the FWD CP.

At a minimum, the following nets will be established by the FWD COC before passage of C2:

- Division Fire Support Coordination—Div FSC (very high frequency [VHF]).
- Artillery Regiment Fire Direction—Arty Regt FD (VHF).
- Artillery Regiment Tactical—Arty Regt TAC (VHF).

The following is one technique for passage of C2:

(FWD) “__the Marines, This is __th Marines FWD, over”

(Main) “This is __th Marines, Roger, over”

(FWD) “Are there any updates at this time? over”

(Main) “Updates are as follows...”

(FWD) “Roger, I am prepared to assume control, over”

(Main) “Roger, __th Marines FWD, out”*

(FWD) “__th Marines, out”*

* Call signs change, making passage of C2 “invisible” to supported units.

Actions Upon Arrival of Main Body

- A guide is sent to the pick-up point to facilitate a rapid, orderly occupation by the main COC.
- Representatives from every section meet their respective vehicles to guide them into position.
- The planning cell is established.
- Position improvement is continuous.
- Several tactical procedures may be used for a rapid passage of C2 back to the main COC. One way is the main COC collocates with the FWD COC. This eliminates establishing extra communications nets and structural reorganization.

Displacement

Artillery displaces to provide continuous support, maintain communications, and enhance survivability. Considerations include security requirements, threat activity, time available to move, distance to be covered, the scheme of maneuver, and the availability of artillery. The terrain and tactical situation influence the distance and frequency of displacements. Generally, the distance of displacements is at least one-third the maximum range of the howitzer. However, survivability moves may be a shorter distance. The route and timing of displacement must conform to the operation or the supported or reinforced unit. The movement may be deliberate or hasty. Artillery can displace by ground or helicopter.

When two or more artillery battalions displace over the same route, the higher artillery headquarters coordinates the movement. When artillery must displace on a route used by other units, the maneuver commander coordinates the movement

and establishes route precedence. DS units have route precedence over all other artillery.

During displacement, reliance is on radio communications. Displacements and the daily change of call signs/frequencies should be coordinated to prevent interference between the two actions.

Arrangements for transfer of fire support responsibility are made as early as possible. Priority targets must be covered during displacements.

Execution

A unit in DS displaces when deemed necessary by the artillery unit commander based on the operations of the supported unit or when ordered by higher artillery headquarters. The artillery commander coordinates the time of movement, route, method of displacement, and the new PA with the supported unit.

An artillery unit with a reinforcing mission displaces on request of the reinforced artillery unit or when ordered by higher artillery headquarters. The reinforcing unit notifies the higher artillery headquarters of the method of displacement, completion of displacement, and new position location.

An artillery unit with a GS or GS-R mission displaces when ordered by the artillery regiment. The unit commander recommends to the regiment the PA, route, method of displacement, and time of displacement. For GS-R artillery, the regiment may assign the GS-R mission to another unit while the displacement is in progress.

Methods

The methods of displacement are based on the tactical situation and the requirement to continuously control subordinate units. The main echelon may displace as a unit when detailed control is not required. When continuous detailed control is required, the main echelon

will displace in increments. Regardless of the method, communications must be continuously maintained with the supported unit, reinforcing artillery, higher artillery headquarters, and between headquarters' echelons. In extreme situations during displacement, control of the regiment may be transferred to one of the battalions, or control of the battalion may be transferred to one of the firing batteries.

Unit Displacement

The battalions displace with all elements moving at once. Unit displacement is fast and can be easily controlled since no firing is required. This method is useful when a battalion is supporting a unit not presently in contact; when a battalion is making a long move; and when a reinforcing unit is available to deliver fires to the supported unit while the DS battalion is displacing. Considerations include the size of the convoy, traffic conditions, and the loss of flexibility once the movement has started. When the regiment COC must displace by unit, regiment control will be passed to one of the battalion's FDCs. Passing control to a battalion with a DS tactical mission should be avoided whenever possible.

Echelon Displacement

Battalions displace one or two firing batteries, an increment of the headquarters, and some CSSEs in one echelon while the rest of the battalion stays in position. When the first echelon is in position and ready to fire, the second echelon displaces. This method provides continuous but degraded support to the supported unit, and facilitates and reduces C2 convoy size. It is useful when the supported unit is expecting/encountering light resistance. The commander's flexibility is limited. The commander normally goes with the first echelon; the executive officer (XO) stays with the second.

Echelon displacement is the preferred method as it provides continuous C3. The headquarters element will displace on order of the regiment commander. Displacement should be invisible to subordinate

and supported units. The FWD COC will move to the new COC site while the main COC retains control of the regiment. Once established, the FWD COC assumes control of the regiment and the main COC moves to the new COC location.

Prior to displacement, the communications officer will coordinate communications plan changes with higher, subordinate, and adjacent commands. Each COC will maintain the capability to staff the minimum required radio nets during displacement.

Passage of C2 forward will be kept as simple as possible, especially when encrypted communication equipment is used. The FWD COC will remain off the fire direction and tactical nets until ready to assume control. Updates of essential information will be passed forward from the main CP prior to relinquishing control.

Typically, the S-3A displaces with the FWD COC while the S-3 remains with the main CP. Specific configuration and manning is mission-dependent and at the discretion of the regiment commander.

Battery Displacement

Each battery moves only after the preceding battery has completed its move and is prepared to fire. This method provides maximum continuous fire support and centralized C2, but is slow and difficult to control over any distance. It is used primarily by a battalion supporting a unit in contact and is normally accomplished in a series of short moves.

Hasty Displacement

The tactical situation may require the unit to displace with little warning or preparation time. The battery conducts a hasty displacement when it has enough time to expeditiously organize and conduct the displacement. This situation may arise because of imminent threat attack or a change in the friendly situation. The senior Marine in the position must quickly assess the situation and signal the hasty displacement by audible and visual means. An advance party is rapidly assembled and

departs to the new position. A limited-time preparation of the new position may be required. Firing elements and a fire direction element depart after the advance party leaves. Remaining elements close to the new position as soon as possible.

Emergency Displacement

The tactical situation may require a battery to displace immediately. An emergency displacement is conducted when a battery must urgently leave its position to avoid casualties and damage to equipment. This situation normally occurs as a result of threat attack.

Time is not available for organization for the displacement. Unit SOP, training, and small unit leadership guide the displacement. A reconnaissance party with minimum essential personnel, equipment, and vehicles meets at a predetermined point as rapidly as possible and departs to the new position. A limited-time preparation of the position is made. Mission-essential equipment and equipment of value to the threat are loaded as rapidly as possible and moved to the rally point. Mission-essential equipment includes prime movers, howitzers, FDC and COC, and enough communications, ammunition, and other assets to begin firing

at the next position. Non-essential equipment is left in the position and recovered after the attack and the unit is reassembled.

The senior Marine in position must rapidly assess the situation when deciding to signal an emergency displacement. He/She must consider the exposure of personnel and equipment in executing the displacement; i.e., the unit's vulnerability may increase. During position improvement, a unit can enhance its capability to conduct an emergency displacement by practicing the following measures:

- Position vehicles close; e.g., near gun line or FDC but with adequate dispersion to ensure single artillery or mortar round will not disable both systems.
- Operate with only mission-essential equipment and personnel.
- Download equipment/supplies only as necessary.
- Prepare positions for rapid exit; e.g., suspend camouflage nets overhead with an exit readily accessible; use radio vehicles and field expedient antennae for communications.

CHAPTER 4

THE ARTILLERY DEFENSE PLAN

General

When conducting ground combat operations, units must be prepared to defend themselves against various threats, including air and ground attacks. A responsibility of artillery is to deliver timely, accurate fire. Traditionally, artillery continues its mission and repels/sustains the attack. The artillery commander has the difficult task of planning a defense that provides adequate security for his/her unit without needlessly reducing its ability to deliver timely, accurate fire.

Combat Operations Center Security

Provisions for security and installation of an adequate defense for the COC promote the accomplishment of the overall mission of the regiment. Preparations will be made to counter any form of attack. The COC can defend itself without outside aid. COC defense will be developed, as permitted, by available time, situation, and necessity. The headquarters battery commander will develop detailed procedures for planning, preparing, and executing COC defense.

The defense of the COC will be maintained by assigning primary, secondary, and contingent sectors of responsibility to each security position. This includes positioning automatic weapons and rocket launchers to cover all avenues of approach, and forming a reaction platoon from organic personnel. Sectors of responsibility for all weapons will be assigned and coordinated to ensure complete coverage of the COC perimeter. Each Marine will be assigned a definite fighting position in the event of attack.

Evaluate the Threat

Knowledge of the threat capability allows the commander to focus on those tactics and techniques that reduce vulnerability. Unit positioning, organization of position, formation, dispersion, camouflage, employment of weapons and early warning assets, and the order of work are geared to the threat. This does not imply that the commander disregards other threats as the battlefield threat will change rapidly. The commander may be faced with multiple threats. The S-2 can provide valuable information on the threat's ability to acquire and attack targets. Threats should be prioritized and sound tactical decisions made to counter them. The commander assesses the threats and focuses his/her efforts to maximize his/her available time and assets. Important considerations include the following:

- Target Acquisition Capabilities:
 - Radio direction finding.
 - Counterfire radar.
 - Flash/sound ranging.
 - Visual detection from air or ground.
 - Photographic and thermal detection devices.
 - Night observation devices.
- Means of Attack:
 - Fire by artillery or mortars.
 - Air attack by fixed- or rotary-wing aircraft.
 - Infantry assault.
 - Mechanized assault.
 - Infiltration and sabotage.
 - Jamming and imitative deception.

Avoid Detection

The unit's best defense is not to be detected. A unit that is concealed or that cannot be recognized has greatly increased its survivability. The commander employs various tactics and techniques to avoid detection and enhance survivability should the unit be detected. Units must practice deception.

Use Camouflage

The unit avoids detection by camouflaging the six factors of recognition: position, color, shape, shadow, texture, and movement.

Artificial camouflage is used to avoid detection. Pattern painting of equipment and a lightweight screening system (nets) are artificial camouflage techniques. Nets are erected to break up the shape of the equipment and should not restrict firing capability of weapons or exit from the position. Vehicle wheels/tracks are not painted and are easily detected without camouflage.

Natural camouflage blends the unit in with the environment. This is achieved, in part, by positioning and using contours, trees, buildings, debris, and other surroundings. Artillery units are positioned in micro terrain; i.e., ravines and gullies, increasing survivability by decreasing the chance of the threat targeting the unit by map analysis.

Reduce Electronic Signature

Electronic equipment must be properly sited. All battery equipment is positioned to decrease exposure. Directional antennae, remote antennae, and wire are used to avoid detection.

Maintain Light and Noise Discipline

This includes personnel and equipment; i.e., vehicle engines and generators. For reduced detection and increased survivability, noise-producing equipment is positioned and hardened.

Reduce Weapons Signature

The muzzle flash of a howitzer can be seen at great distances, particularly in open terrain. To avoid detection, defilade positions, propellant flash reducers, and gunnery techniques are used; i.e., massing fires, low trajectories, and fires without adjustment.

Establish a Track Plan

Available existing roads and trails should be used whenever possible. Roads and trails can be created with heavy vehicles to give the appearance that a unit has moved through the area. Roads and trails must have logical starting and ending points. Soil, debris, and movement can degrade camouflage.

Use Dispersion

In terms of time and effort, dispersion is the least expensive method of avoiding detection and increasing survivability. Dispersion of equipment and installations minimizes the effect of an air or counterfire attack. Grouping differing assets in proximity should be avoided as this will only increase the unit's chance of detection. For example, if the antenna farm is detected by EW and located near a howitzer position, the artillery section's chances for survival are decreased. The degree of dispersion depends on the terrain, threat, and the degree of C2 required. As a guide, a battery should be dispersed with howitzers at least 100 meters apart. The FDC should be placed according to METT-T (either near one of the flank howitzers or in the center of the battery position) following the same dispersion rules. However, less dispersion is recommended if the threat is an infiltration-based ground attack.

Practice Communications Security

Signal, information, and physical security practices degrade the threat's ability to detect a unit. Short radio transmissions (less than 25 seconds), low power transmissions, and secure transmissions are recommended.

Displace

When possible, displacing should occur in reduced visibility. Survivability moves are conducted, when required.

Conduct Terrain Analysis Using KOCOA

Terrain is analyzed to maximize its advantage while reducing vulnerability. Military aspects of terrain are analyzed using KOCOA: key terrain; observation and fields of fire; cover and concealment; obstacles; and avenues of approach.

Key Terrain

Terrain that will afford an advantage over the threat should be physically occupied or controlled. The essential characteristic of terrain is that it permits the unit to accomplish its mission. Operations should not be delayed by seeking a perfect position and should—

- Allow all weapons to deliver fire for maximum coverage of the supported unit.
- Afford defilade and concealment from ground observation. Flash defilade of 10 meters is sought for medium artillery. Too much defilade may limit the field of fire of the weapons in close defense of the position against ground attack or may restrict low angle fires.
- Be free of obstructions that affect the firing capability of a howitzer; i.e. a cliff, building or high tree to the flank.
- Allow for 6400-mil firing capability.
- Be accessible and have separate routes for entrance and exit, preferably in the rear. The position should not be on a threat high speed avenue of approach. Concealed routes to and from the unit are desirable, particularly if the position will be occupied and resupplied during daylight.
- Be on relatively level, firm ground. Very rocky, swampy, sandy or uneven ground will slow the occupation of the position or prevent the effec-

tive operation of howitzers. The position should be trafficable by all vehicles in the unit. The current and anticipated weather should both be considered; i.e., rain, flash floods or snow.

- Establish positions in small trees, brush, isolated open spaces or irregular clearings in vegetated terrain. Good positions can often be found along the edge of a road or trail, but away from crossroads or junctions that may attract hostile harassment and interdiction fire. Also, the unit should not be along the edge of a primary route for supply. Positions located at the forward edge of tree lines, in small clumps of woods or under a solitary line of trees, are easily spotted by the threat.
- Be away from prominent landmarks when positioned in open terrain. The unit should be randomly dispersed over the ground, making good use of contours and artificial camouflage.
- Be in quarries, in ruins or under the roofs of buildings in a town.
- Allow for good communications, preferably by wire, with the supported unit and higher headquarters.
- Be large enough for dispersal of weapons and other installations if there is an air or counter-battery threat.
- Be in a compact, easily defended position in mountains or heavily wooded areas, when friendly forces have air superiority, or when the battery is threatened by guerrilla or infiltration tactics. The unit position should be away from threat-concealed routes of approach.
- Allow for shelter and comfort of unit personnel.
- Have survey control established or survey available in a short time. Hasty survey may be required.
- Consider the unit's future mission or displacement.

Observation and Fields of Fire

Continuous surveillance is established and maintained in all directions through use of OPs and listening posts (LPs). Deny the threat the

advantage of surprise. Properly site weapons to allow clear fields of fire. Ensure fire and observation covers all likely avenues of approach.

Cover and Concealment

Maximize use of available cover and concealment when positioning the unit and establishing defensive positions. All vehicles, howitzers, and equipment should be properly camouflaged with netting or indigenous vegetation. Use protection afforded by defilade. Deny use of cover and concealment to the threat. Identify dead spaces and cover these areas with observation and fire.

Obstacles

Identify all obstacles in the area, both natural and manmade, which could impede movement. If possible, utilize these obstacles in support of unit's defense plan.

Avenues of Approach

Identify all avenues of approach the threat may use. Determine if each is suitable for mechanized or dismounted infantry attacks. Based on this determination, emplace appropriate defensive mechanisms.

Provide Early Warning

Early warning increases a unit's survivability and its capability to respond to an attack. Emphasis on this aspect of artillery defense must be continuous. Early warning is obtained from all available sources organic (sentinel and LPs, OPs, patrols) and other measures (adjacent units, monitoring communication nets and higher headquarters).

Sentinel Posts and Listening Posts

These posts are situated on terrain that provides coverage of all routes of approach into the unit's position. The number of sentinel and LPs depends on the terrain, visibility, and communi-

cations capability. Sentinel and LPs coverage should interlock with each other, with obstacles, and with nearby units to prevent gaps. They should be far enough from the unit's defensive perimeter that the warning of attack allows time for implementing the defensive plan; i.e., the reaction force. This distance will vary with terrain, visibility, likely threats, and unit reaction time. At night, these posts should consist of at least two-person teams with small arms and antitank weapons, dug in, have good cover and concealment, protected by obstacles (i.e., barbed wire), have good fields of fire, and covered by fire from within the position.

Sentinel and LPs should be augmented with night observation and intrusion devices. A continuous wire circuit (hot loop) should be established between all posts and the unit. Alternate methods—such as sound devices, pyrotechnics, and runners—should be ready. These posts are withdrawn on attack using planned withdrawal routes.

Patrols

Avenues of approach and areas that may provide cover and concealment for threat forces should be patrolled or kept under surveillance. Patrolling should be irregular but, at a minimum, conducted at dusk and dawn. The patrol route should intersect areas covered by sentinel/LPs and should be coordinated with adjacent units. The patrol composition will vary. See MCWP 3-11.3, *Scouting and Patrolling*, for more information.

The patrol leader (PL) will coordinate with the commanding officer (CO)/XO and the local security chief. The CO/XO or security chief will coordinate with friendly units immediately affected by the patrol's actions; e.g., movement within friendly areas, departure/reentry of friendly lines, and fire support.

The PL will ensure that all Marines in the patrol know the patrol's chain of command and responsibilities of each member. If the patrol locates a

threat force, it should not engage the threat (unless necessary) but continue surveillance and notify the unit.

The local security chief will control the departure and reentry of patrols in and out of the unit position.

Monitoring the Tactical Situation

By monitoring the tactical nets of the supported unit, artillery can keep abreast of potential threats. As the threat becomes increasingly more defined, the artillery can then appropriately increase the staffing of its defensive perimeter.

Other Measures

The unit employs detection systems and guards as required; i.e., NBC detection and monitoring teams, air sentries, and entrance points for control access into the position.

Make Defensive Preparations

The unit must prepare to defend itself. The unit establishes fortifications, obstacles, and a reaction force. The unit must be prepared to occupy its alternate position, if required. As time permits, defensive plans are made for alternate and supplementary positions.

Organizing the Defense

The local security chief organizes the unit's defensive preparation under the guidance of the commander. In developing the plan, the local security chief walks the surrounding area and determines how the unit might be attacked. He/She can then develop his/her plan with emphasis on avenues of approach. Organization of the defense includes the following:

- Defining the perimeter, designating primary and supplementary fighting positions and sectors of fire.
- For firing batteries, assigning supplementary positions to howitzers. When possible, howitzers are employed in pairs for continuous engagement and increased probability of hit. Consider how howitzers and ammunition will be moved to their supplementary position (route or prime mover).
- Positioning weapons at key locations with good cover, concealment, mutual support, and overlapping fields of fire. Machine guns are given primary and alternate positions. Principle direction of fires (PDFs) and final protective lines (FPLs) are designated.
- Positioning tank-killer teams with antitank weapons and in well-concealed and hardened positions. These positions are covered by fire from other weapons. Primary and alternate positions are assigned to cover avenues of approach into the position. The ranges to likely engagement points are determined.
- Covering gaps by obstacles, barriers, observation, and mutual support of adjacent units, when possible.
- Planning defensive fires on avenues of approach to delay the threat attack. These fires can be delivered by other units or the threatened unit.
- Assigning air sentries sectors to scan and rotating them periodically to enhance alertness. If low altitude air defense (LAAD) teams are available, they should be positioned in depth.
- Considering the coordination of infantry support (or attachment) to protect artillery against a severe ground threat.
- Arranging for ammunition distribution, communications, and signals.
- Providing protection of ammunition, personnel, and equipment from blast and small arms.
- Coordinating a staffing requirement for an adequate degree of security, but not degrading the ability to deliver fire. Minimal but adequate personnel may be employed in perimeter security and reinforced when a threat develops. The perimeter may also be reinforced in reduced visibility. The key to such a defense is responsiveness.

- Ensuring all personnel know the defensive plan and rehearsing the plan as time permits. Each individual must know his/her responsibility and be ready to react rapidly to a threat. A defensive diagram is prepared to depict the
- defense. Ensuring the unit is prepared for triage, first aid, and evacuation of casualties to the aid station, if required.
- Designating reaction forces.

Defensive Diagram

To assist in organizing the defense, the local security chief prepares a defensive diagram. The defensive diagram is a graphic depiction of the position, surrounding terrain incidental to the defense, the positioning of weapons and other defensive resources (such as mines), the location of early warning assets, planned fires, and key installations. MCWP 3-11.3 provides detailed instructions for constructing a defensive diagram to scale.

Range Cards

After sectors of fire are assigned, a range card is prepared (in duplicate) for each direct fire weapon (howitzer and crew-served weapons). The range card has a sketch of the sector of fire and necessary data for the engagement of targets. The local security chief collects completed range cards and uses them to construct sectors of fire on the defensive diagram. Partially completed range cards are prepared for alternate and supplementary positions and completed as time permits. Range cards should be revised continually throughout the occupation of the position. When possible, a laser range finder is used to determine accurate ranges to targets. MCWP 3-11.3 provides in depth instruction on how to construct a range card. Range cards should depict the following:

- Location of weapon.
- Left/right sector limits with azimuth.

- Key terrain.
- Identifiable targets in sector.
- Dead space.
- FPL or PDF.
- List of targets with firing data.

Fortifications and Obstacles

As time and resources permit, obstacles should be constructed to delay, stop, divert or canalize an attack. Barbed and concertina wire, tank ditches, barricades, trip flares, booby traps, and mines (when authorized) may be employed to supplement natural obstacles. These must be covered by observation and fire for effectiveness and employed beyond hand grenade range of protected installations.

Hardening of Positions

Hardening is protection to ensure that a unit can function during and after a threat attack. Hardening can be achieved by digging in; using cover such as sandbags, timber or rubble; or emplacing berms (parapets). The degree of protection depends on time, material, manpower available, and the amount of equipment and personnel to be protected. As a minimum, hardening consists of digging fighting positions on the perimeter, burying wire, sandbagging sensitive equipment (such as collimators and tires), and protecting propellants. As time permits, howitzers, the FDC, battery operations center (BOC), and projectiles are protected. Engineer assets and/or local civilian earth-moving equipment can be used in the hardening efforts.

Reaction Force

A group of unit personnel is designated as a reaction force that can react immediately to any threat within and around the position. Group size varies with the threat but normally has approximately 25 personnel from the unit's sections. The

reaction force staffs normal working stations. When signaled, they muster at a pre-designated location (FDC, COC, etc.) and repel a threat attack and/or reinforce the perimeter. The reaction force counters the threat at a sufficient distance outward to allow a buffer for the unit perimeter to be fully staffed or to gain time for the unit to conduct a hasty or emergency displacement. The reaction force should be capable of employing in two teams and should not pursue the threat if the attack is repelled. The reaction force conducts day and night rehearsals for responsiveness and familiarization with the defensive area.

The local security platoon is organized and employed by the local security chief under direct control of the headquarters battery commander. Responsibilities of the local security chief are to—

- Assist the headquarters battery commander in controlling the operation of the security platoon and the reaction force.
- Position security points both inside and outside the COC.
- Ensure required signaling devices are installed and operable and procedures are established for their proper use.
- Conduct small unit patrols as required.
- Assign personnel to machine gun positions.
- Perform other duties as directed by the headquarters battery commander.
- Construct defensive diagrams.

Coordinate with Adjacent Units for Mutual Support

Coordination with all adjacent units greatly enhances the defensive plan. By sharing information and incorporating elements from other units (patrols, air defense weapons, indirect fires, final protective fires (FPFs), etc.), each unit involved can take advantage of a defense which, as a whole, is better than the part. Also, to prevent

fratricide, coordination is critical so that each unit is aware of all friendly patrols operating nearby.

Execute Defensive Action

When an attack occurs, the commander or senior Marine in position quickly assesses the situation and determines a COA. He/She considers the strength of the threat and its effect on the unit's operational capability. Depending on this analysis, the commander determines one of the following courses of action:

- The unit **can** repel and/or sustain the attack. Actions are taken to counter the threat.
- The unit **cannot** repel and/or sustain the attack. The unit executes a hasty displacement. The unit notifies its higher headquarters and proceeds to its alternate position. Preplanned fires/smoke to assist disengagement are considered, if required.

Active and Passive Defense Measures

Active defense measures consist of the use of all organic and attached weapons with the aggressive employment of all personnel to repel an attack. Individual arms, automatic weapons, machine guns, and antipersonnel/antitank mines will be employed.

Passive defense measures consist of measures taken to conceal or disguise the COC by providing protection for weapons, together with preparing obstacles to slow the threat and establishing a warning system to alert the unit. COC concealment involves careful selection of a position that takes advantage of the natural terrain. Camouflage of the position consists of measures using materiel, objects, and simulation devices. All tents, vehicles, and other major equipment will be camouflaged. Generators should be positioned to muffle sound.

Reversing slopes from the threat using foliage or digging holes can assist in this effort.

Signals

Although commanders will designate specific signals to correspond to various threats or conditions, the following three signals are standard.

Defense Against Air Attack

Low level strafing and bombing attacks usually occur during daylight hours. Upon the sounding of the air attack signal, personnel will assume air defense positions and all weapons systems will engage the aircraft.

NBC Defense

The signal for an NBC attack will be continuous banging of metal on metal. When the alarm is sounded, all personnel will immediately don and clear their field protective masks and remain masked until the “all clear” signal is sounded.

Ground Attack

Upon the sounding of the ground attack signal, the reaction force will assemble at the rally point with their assigned gear. Primary watch standers remain in place and all other non-essential personnel report to their assigned fighting positions.

Reconstituting the Unit

If a unit becomes ineffective as a result of threat action, specific actions must be taken to reconstitute the unit or return it to a desired level of operational readiness. Cross training and an SOP

facilitate reconstitution. The following actions are taken:

- Report the situation to higher headquarters.
- Render first aid and evacuate casualties.
- Assess damage, repair equipment, when possible, and redistribute assets, as required.
- If attacked by NBC, decontaminate personnel and material.

Special Considerations for Command Elements

CPs and logistics areas are particularly vulnerable to threat attack due to a lack of organic firepower and susceptibility to target acquisition threats. Proper communications security and operations security techniques are essential to mask a CP's signature. Vehicle traffic in and out of the position should be limited and strictly controlled. All sections of a headquarters battery must plan to staff local security posts even if this effort degrades certain operational capabilities.

If the threat of air attack or artillery fire is minimal, CEs may consider collocating with other units to enhance survivability and common defense. For example, a battalion FDC may occupy a position in the vicinity of its supported infantry regiment COC. Similarly, logistic elements may consolidate defensive responsibilities with their supporting combat service support detachment (CSSD) in a low threat environment. This arrangement would be undesirable in a high threat environment where tactical dispersion would be maximized to enhance survivability.

Because the sections in the headquarters battery will seldom be colocated, it is imperative that all elements are identified with respect to size, capabilities, and position on the battlefield. At a minimum,

local security must be considered and planned for the FWD COC, main COC, and logistical trains. Determine the following for each element:

- Mission and tasks assigned.
- Personnel located at each site.
- Vehicles and other section equipment needed to support its mission.
- Crew-served weapons required to provide adequate protection.
- Fire support available.

- Will this element operate independently, be attached to another unit or be collocated with another unit?
- Who is in charge?

Once these requirements have been determined, the artillery defense plan must be tailored to meet the specific needs of each element. The plan must consider that the threat may be different to each element.

CHAPTER 5

BATTALION OPERATIONS

Mission

The mission of the battalion is to provide close and continuous artillery support to MAGTF operations. This support includes accurate and responsive fires in support of maneuver, long-range fire to establish operational depth, counter-fire to defeat threat fire support systems, and assistance in integrating all fire support assets into combat operations.

Organization

An artillery battalion consists of a headquarters battery and, normally, three firing batteries. See figure 5-1 on page 5-2. The headquarters battery provides the equipment and personnel to assist the battalion commander control and support his/her battalion, and establish an FSCC for the supported maneuver regiment. Like the regiment, the battalion headquarters may employ in a main and rear echelon configuration to best support the requirements of higher or supported units. The artillery battalion commander will be located where he/she can best control and plan fires. When assigned the supporting relationship of DS, he/she serves as the infantry regiment FSC.

Functions and Employment

The artillery battalion is the basic tactical fighting unit. It has enough firing units to effectively mass its fires and engage several targets simultaneously. The battalion normally employs as a unit to meet fire support requirements defined by its

assigned tactical mission. The battalion maintains communications with its batteries and any attachments, the supported/reinforced unit, and the artillery regiment, as appropriate. When a battalion deploys independently, it receives augmentation from the artillery regiment; e.g., met support.

When possible, an artillery battalion is associated through training and liaison with an infantry regiment. On deployments, battalions normally support the GCE by providing artillery liaison officers, FOs, and shore fire control parties to these regiments, as required. Artillery and naval gunfire (NGF) personnel may also be provided to separate maneuver battalions or other units as dictated by the tactical situation and the mission assigned to an artillery unit.

Duties and Responsibilities of Battalion Operations Personnel

Battalion Commander

The artillery battalion commander executes the fire support responsibilities inherent to his/her assigned tactical mission. He/She is responsible for the training, morale, and discipline of battalion personnel. During operations, the commander reconnoiters routes, PAs, and observation sites. He/She guides his/her staff and subordinate commanders in fire direction, fire planning, and CSS. When assigned the tactical mission of DS, the artillery battalion commander is normally assigned to duty as regiment FSC. He/She maintains liaison with the supported or reinforced unit commander. He/She also provides expertise and advice on fire support coordination to the supported commander.

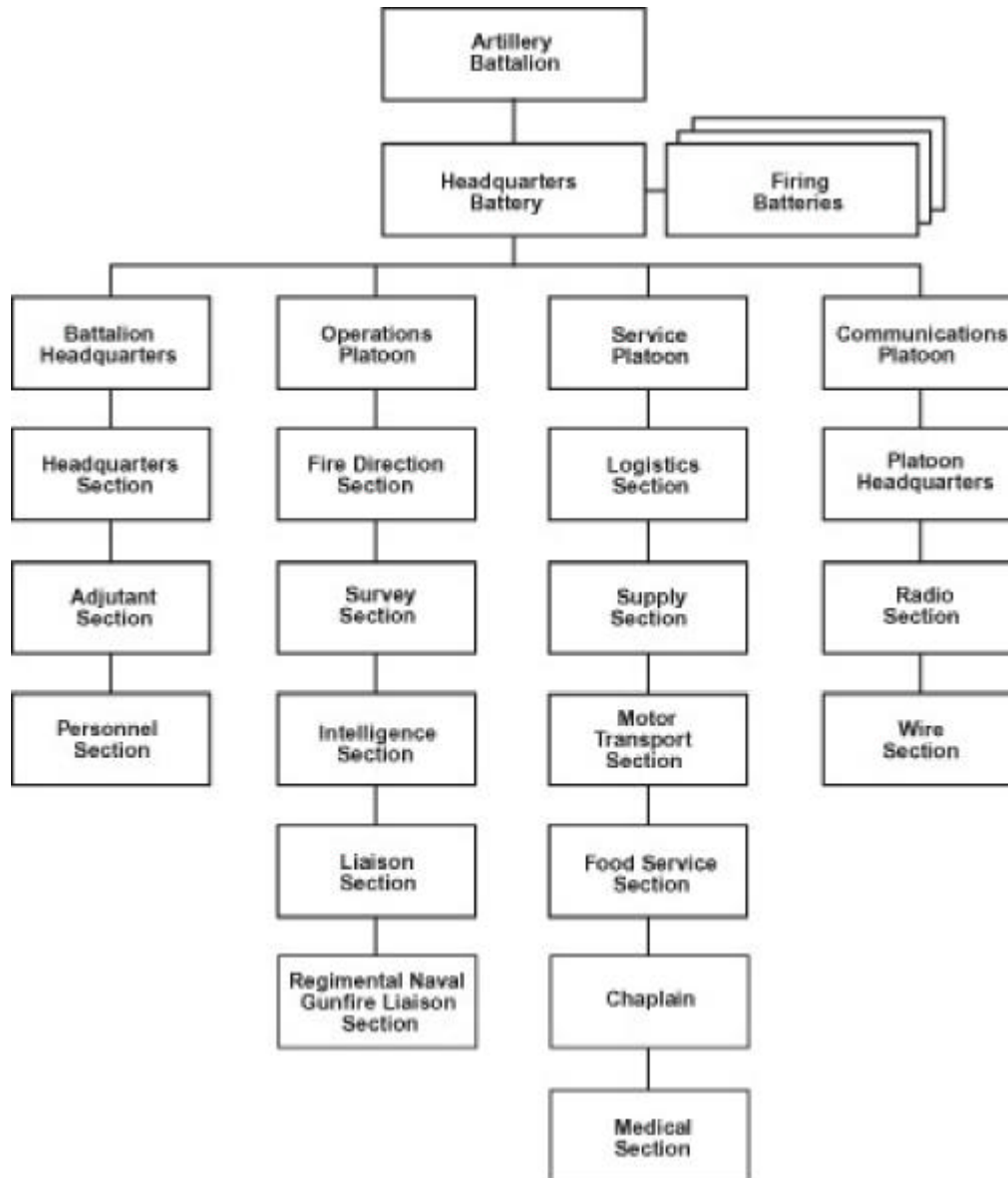

Figure 5-1. Artillery Battalion.

Battalion Liaison Officer

The battalion LNO provides artillery representation in the regiment FSCC. He/She monitors artillery regiment fire direction nets to maintain situational awareness and keep abreast of artillery fire planning and significant artillery missions. He/She also ensures the S-2 and/or TIO are advised of all target information received through artillery channels. Specific duties are outlined in MCWP 3-16.

Battalion Operations Officer

- Prepare artillery OPORDs, letters of instruction, and operational reports.
- Supervise the operation of the main COC.
- Interpret commander's guidance and incorporates it into the artillery fire plan.
- Coordinate movement of the FWD COC.
- Develop a scheme of positioning, displacing, and moving units under the battalion's control.

- Coordinate use of attached assets.
- Coordinate the delivery of artillery support; stay abreast of the supported unit's tactical situation for adequate and safe artillery support; keep others informed of the artillery situation, such as ammunition status.
- Employ operational security and EW in artillery operations.
- Work closely with commanders, other staff officers, and the staffs of higher, lower, reinforcing, reinforced, and supported units on artillery; keep the S-2 informed of all targets attacked or planned for attack and advise on changes in observation and intelligence requirements.
- Coordinate the activities of LNOs.
- Work with the S-4 and S-6 to keep them situationally aware of the current ammunition status and communication requirements, respectively.
- Coordinate survey activities.

Battalion Assistant Operations Officer/ Fire Direction Officer/Watch Officer

The assistant operations officer executes the fire plan and manages the assets under the battalion's control. In the absence of the S-3, he/she executes the responsibilities of the S-3. In addition, he/she has the following responsibilities:

- Supervise the operation of the FDC.
- Ensure dissemination of information to subordinate units.
- Perform tactical fire direction.
- Brief COC watch officer in accordance with appendix E.
- Perform tactical fire direction to coordinate the attack of targets generated by the intelligence section, higher headquarters, and attached units.
- Review schedules of fire to alleviate unnecessary duplication and to execute as appropriate.
- The battalion FDO, assisted by battalion fire direction personnel, trains battery FDC personnel

and ensures battery FDCs manage muzzle velocity variances (MVVs), weapons information, and ammunition.

Battalion Operations Chief

The battalion operations chief is the principal assistant to the operations officer. Duties include, but are not limited to, the following:

- Perform tactical/technical fire direction.
- Supervise operation of the COC.
- Ensure a COC journal is continuously maintained.
- Ensure all SITMAPs and overlays are current and applicable.
- Supervise the COC's establishment and displacement.
- Establish a watch schedule.
- Maintain accountability of all COC personnel.
- Assist the S-3 and watch officer in their duties.

Battalion Assistant Operations Chief

The battalion assistant operations chief is the principal assistant to the assistant operations officer/FDO/watch officer. Duties include, but are not limited to, the following:

- Supervise inventories and loading of equipment.
- Supervise vehicle maintenance.
- Prepare COC supply requisitions.
- Assist in fire planning.
- Assist the operations chief in his/her duties and responsibilities.

Tactical Policies

Tactical policies for the artillery battalion are the same as the artillery regiment.

Battalion Combat Operations Center

The battalion COC is composed of similar personnel with respect to the regiment COC. See figure 5-2. The battalion COC structure is similar to the regiment and employs the following agencies:

- Main COC.
- FWD COC.
- ALOC.
- Alternate regiment COC.

The battalion main COC is responsible for C2 of the battalion and must be prepared to serve as the alternate regiment COC when severe degradation or catastrophic loss of C3 occurs within the regiment COC. Each battery FDC must be prepared to tactically control the battalion's fires and serve as the alternate battalion COC. The alternate COC for the battalion will be designated in the applicable operation or fragmentary order. Assumption of control and passage of C2 will follow the procedures in chapter 2.

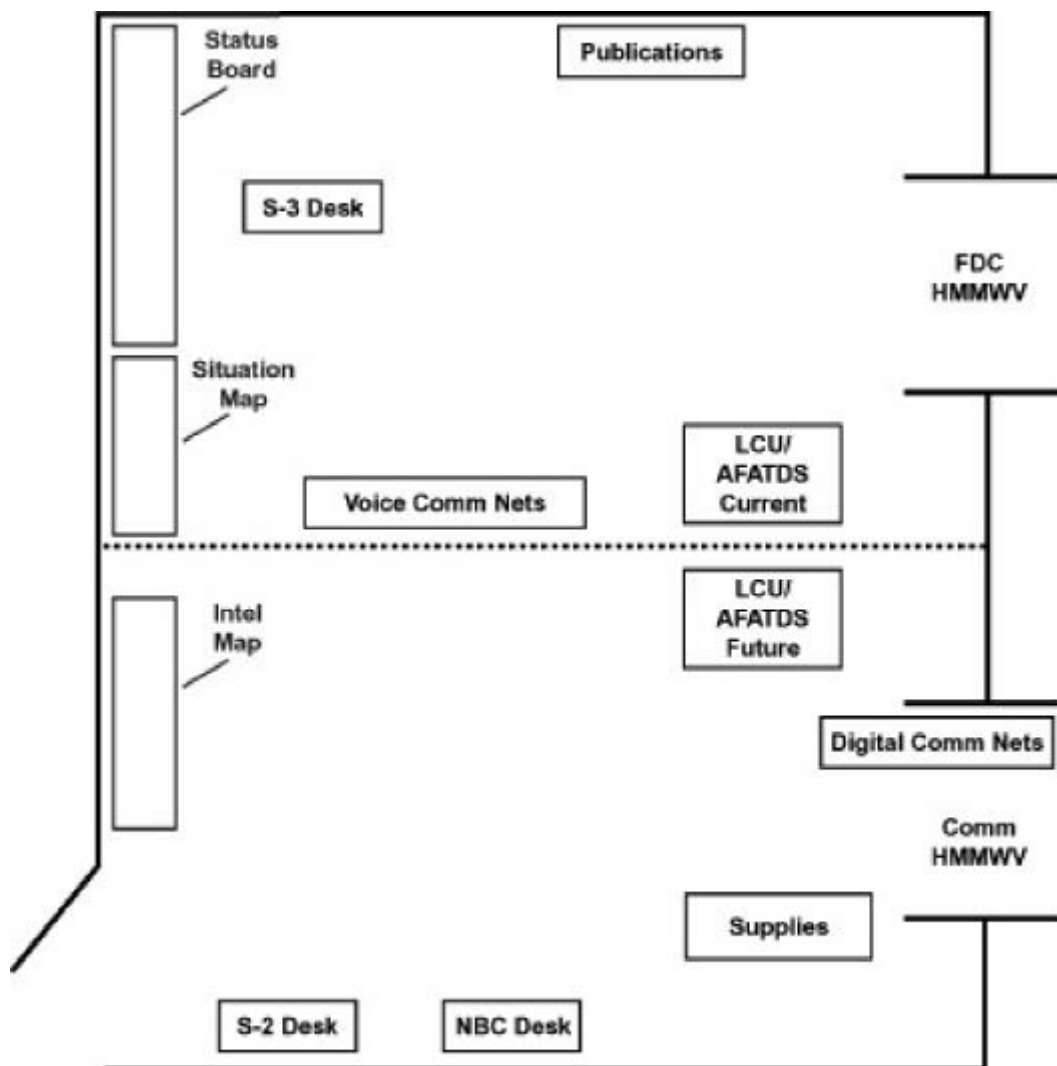

NOTE: All COCs should contain one entry point to facilitate the control of personnel on the access roster.

Figure 5-2. Example Battalion COC Configuration.

Battalion Fire Direction Center

The battalion FDC is composed of personnel from the operations platoon. Watch sections operate similarly to the regiment FDC. The battalion communications platoon provides equipment and personnel to the FDC. Functions of the battalion FDC during operations include fire direction and movement and positioning of batteries.

The tactics, techniques, and procedures in this chapter apply in a digitized environment.

The battalion FDC has primary responsibility for tactical fire direction in the battalion. The extent that tactical fire direction is exercised is situational-dependent. In some situations, the battalion FDO may make all tactical fire direction decisions. In other situations, tactical fire direction may be decentralized; e.g., when a battery is operating independently; when the battalion is unable to maintain communications with a battery; or when batteries are widely dispersed. Every effort is made to exercise control over the batteries before decentralizing tactical fire direction. Regardless of the degree of centralization, the battalion FDC works closely with battery FDCs. The battalion FDC can provide valuable guidance on techniques for engaging targets.

Centralized Tactical Fire Direction

Centralized tactical fire direction equates to authority to make decisions regarding fire missions, how fire control is executed, and how calls for fire are answered. The degree of control may be that the battalion controls all fire missions directly or it intercedes, as necessary. The degree of centralization is dictated by the tactical situation, communications, and the FDC's personnel strength, training, and expertise.

Normally, the battalion FDC answers all calls for fire, makes all tactical fire direction decisions,

and assumes control of fire missions on the nets. Fire orders are then transmitted to firing batteries, as appropriate.

Decentralized Tactical Fire Direction

Fire missions can be transmitted on artillery COF nets established by the battalion. For responsiveness, calls for fire are sent to a firing battery assigned to a specific artillery COF net, each controlled by the battalion. Battery and battalion FDOs concurrently analyze the fire mission. The battery FDO determines how to attack the target; the battalion FDO provides guidance and intercedes, as necessary. Considerations include the nature of the target, recommendation of the requester, attack guidance, commander's guidance, firing restrictions, ammunition status, accuracy, gun-target line, survivability, and FSCMs. Call for fire procedures are as follows:

- Call for fire is received by the battery.
- The battery FDO transmits a request for additional support to the battalion FDC, if required. If the battery FDO determines his/her battery can adequately meet the mission requirements, he/she issues a fire order and monitors the transmission of the message to observer (MTO).
- After monitoring the call for fire or battery FDO's MTO, the battalion FDO intercedes as necessary. He/She may decide to mass the battalion, request R fires, give the mission to R artillery or another firing battery, use a different shell fuze combination or volume of fire, assign aimpoints for engagement of large targets or pass the request to the FSCC to assign the target to another supporting arm. The battalion FDO announces his/her decision using a fire order. If the battalion FDO decides to mass the battalion, the battalion FDC may assume control of the fire mission.
- FSCC approves.

When required by the situation, the battery FDO may make his/her own tactical fire direction decisions. Each battery will establish a separate artillery COF net and will act as net control. The net is monitored by the battalion FDC as communications allow. The battalion FDC responds to requests from the batteries and assists where applicable.

See appendix A for fire direction procedures when operating with AFATDS.

Provision for Continuous Support

An artillery battalion in DS must provide continuous support, even during displacement. To accomplish this, the battalion may identify an artillery COF net for use by a maneuver battalion and assign a firing battery to guard the net. When a battery cannot fire, the battalion FDC may assign another battery to guard the artillery COF net or the battalion FDC may guard it, assume control of fire missions on the net, and issue appropriate fire orders.

Fire Missions from Other Sources

An artillery battalion with a DS mission may receive fire missions from other sources than its FOs; e.g., the battalion FDC may initiate fire missions. An artillery battalion with an R or a GS mission may receive fire missions originated by the reinforced battalion, as appropriate, or the artillery regiment. For these fire missions, the battalion FDO/watch officer makes the appropriate tactical fire direction decisions and issues fire orders to the batteries. After the mission terminates, the battalion FDO sends a FIREP to the unit that originated the mission.

Reinforcing Artillery

The FDO will assign a unit to reinforce another for a particular fire mission. The reinforced unit will provide replot data of the target to its R unit. Communications between units will be on the artillery battalion fire direction net. If positive communications cannot be established between them, the battalion FDC will act as relay. After

the fire mission, R units will resume normal operational status.

R artillery will establish communications with reinforced artillery over the higher artillery regiment fire direction net or the reinforced unit's fire direction net. Fire missions will be directed by battalion fire order or as described in the preceding paragraph "Fire Missions from Other Sources."

Movement and Positioning

The artillery battalion S-3 directs the positioning and movement of the firing batteries and other artillery units operating under the battalion's control. In the DS mission, the battalion S-3 coordinates the movement and positioning of the DS battalion and any reinforcing artillery. The regiment S-3 coordinates for GS and GS-R battalions. The battalion S-3 coordinates the movement with the battalion S-2 and S-4 and issues movement orders to the batteries. Batteries submit DISREPs and FIRECAPs to the battalion. The battalion commander directs the movement and positioning of the headquarters battery.

Other Battalion Fire Direction Center Functions

Other battalion FDC functions are similar to those performed by the artillery regiment FDC. For ammunition, the S-3 identifies the type, quantity, location/unit, and required time/date for ammunition resupply. The battalion FDC maintains an accurate ammunition status of the battalion. The battalion S-3 assigns firing batteries to priority targets and assigns priority of fires. He/She also establishes battalion fire order standards and coordinates the assignment of FOs and LNOs. Targeting is conducted in concert with the regiment.

Special Missions

When firing special missions, it is vital that all procedures for the battalion are clearly understood by all subordinate units. Special missions include priority targets, final protective fires (FPFs), immediate suppression, continuous

suppression, immediate smoke, quick smoke, danger close, scheduled fires, FASCAM, and suppression of enemy air defenses (SEAD). Unit SOPs should address these special missions and provide standard engagement information.

Battalion Survey

The mission of battalion survey is to provide a common grid over the battalion AO. The battalion survey section normally performs fifth order level surveys to provide control to all units organic or attached to the battalion. In some cases, the battalion survey section may be tasked to provide control to units requiring survey that are unattached to the battalion, but operate within the battalion's area.

Battalion Survey Officer

The battalion survey officer is a member of the battalion special staff. Duties include, but are not limited to, the following:

- Accompany the battalion commander or his/her representative on reconnaissance of the new position.
- Advise the commander of the capabilities and limitations of survey, radar, and met.
- Formulate and implement the battalion survey plan.
- Maintain close liaison with the battery commanders and coordinate survey operations within the battalion.

Survey Chief

The survey chief is the principal assistant to the survey officer. Duties include, but are not limited to, the following:

- Perform, when directed, any or all battalion survey officer duties.

- Ensure all survey data is correctly derived, transmitted, and filed.
- Supervise and train surveyors in operations and maintenance of survey equipment.

Chief of Party (Conventional and Position and Azimuth Determining System)

- Train his/her survey party.
- Supervise and coordinate field operations of his/her survey team.
- Responsible for the maintenance and accountability of his/her equipment.

Survey Recorder/Computer

- Maintain the required forms for survey computations.
- Perform independent computations with a survey computer system.
- Maintain the survey section's computer systems.
- Perform the duties of chief of party in his/her absence.

Instrument Operator

Operate and perform preventive maintenance checks and services on team survey equipment.

Battalion Survey Methods

All battalion survey sections will accomplish field work procedures and computations involved in GPS surveying, traverse, intersection, resection, hasty survey, and astronomic observation techniques in accordance with MCWP 3-16.7. MCWP 3-16.7 contains information on the following survey topics:

- Starting control.
- Distance determination.
- Angle measurement.
- Recorder's notes/closure of survey.
- Computations.

Station Marking

All stations surveyed by battalion teams will consist of a standard surveyor's hub driven almost flush with the ground with a surveyor's tack in the center indicating the plumbing point.

Each battalion will be allotted a block of numbers, by regiment, to designate firing points. Adjustments will be made, if necessary, to accommodate attached survey sections.

The orienting station (OS) hub will have a tag affixed with the following information:

- Date established.
- Station name.
- Direction to end of orienting line (EOL).
- Instructions.

The EOL hub will be tagged with the following:

- Date established.
- Station name.
- Instructions.

The OS will be witnessed by a yellow stake. The EOL will be witnessed by a yellow and red stake. Witness stakes are not required to be tagged.

Firing Position Data Card

Battalion survey officers will give a firing position data card to the battery commander or his/her representative with the following information:

- Grid to OS (grid to EOL is optional for use when 6400-mil capability is required).
- Azimuth and distance from OS to EOL.

Priority of Survey

- Establish OS/EOL for the batteries.
- Establish declination stations.
- Extend control to CBR sites.
- Extend control to met stations.
- Perform target area surveys.

- Assist other units (mortars, PLRS, EW, etc.), as required.

Reconnaissance for Movement of the Battalion

The artillery commander initiates reconnaissance based on his/her knowledge of the tactical situation or as a result of a change in mission. Movement and positioning are driven by fire support requirements, the tactical situation, communications, and survivability. The artillery battalion commander selects positions that allow the battalion to accomplish its mission.

Although earlier paragraphs establish the precepts for displacement and advance party operations, it is important to distinguish between regiment and battalion operations. Battalions operate at a higher tempo and must synchronize their movement with the supported maneuver unit, reinforced artillery unit or higher regiment headquarters, depending on their assigned tactical mission. These movements must also support the artillery regiment's concept of operations.

Planning the Reconnaissance

Effective reconnaissance must be planned to anticipate the needs of the higher artillery unit and the supported unit. Planning varies with the mission, time available, and method of reconnaissance.

The commander plans and coordinates the reconnaissance. He/She analyzes the tactical situation to identify positioning requirements. By map reconnaissance, he/she identifies a potential PA. He/She coordinates potential areas with the supported/reinforced unit and higher artillery headquarters, as appropriate. The commander determines the presence of other units (or their planned occupation of positions in the vicinity of the area) and routes to be reconnoitered. Provisions may be required to

bypass friendly units along the route. The commander considers the distance and route to the new area and availability of personnel and equipment. He/She then determines how to conduct the reconnaissance, composition of the reconnaissance party, reconnaissance routes, and time available. He/She develops his/her plan, plans fires, and issues orders for execution.

The S-2 provides information to help the commander plan and execute his/her reconnaissance. Information includes the threat, camouflage, visibility and trafficability, weather, and obstacles. Some information sources are other unit's reports, air observers, FOs, and LNOs.

The S-3 recommends to the commander the movement and positioning of the unit. The S-3 considers the coverage to the supported/reinforced unit; the ability to mass fires; terrain and weather; and the threat. If necessary, nuclear/chemical dosage rates and levels of contamination are considered.

The S-3 ensures that positions can be supported by communications and CSS, and that new PAs meet survivability requirements. Based on the commander's decision and guidance, the S-3 makes PA assignments, designates azimuths of fire (AoFs) or aimpoints (such as grid intersection); arranges for route precedence; and issues warning and/or movement orders.

The S-3 directs survey operations to support the positioning plan. Close coordination is required among the S-3, the survey officer, and battery commanders. The survey party may precede the battery commander to a firing position designated by the S-3; link up with the battery commander during RSOP; or extend survey to the position after the selection by the battery but before occupation.

The S-4 plans CSS for movement and positioning of the unit. He/She coordinates engineer support and arranges for CSS to displacing units; i.e., repair and replenishment point (RRP).

Movement Briefing

The artillery commander assembles and briefs key personnel on his/her reconnaissance plan. A general format for this brief follows:

Situation

- Threat situation, including known or likely ground or air activity, obstacles, etc.
- Friendly situation, including locations of friendly units along routes and in the position areas, obstacles, etc.
- Mission, what is to be accomplished from the new position.

Execution

- The commander points out, on the ground or on a map, positions and locations (or tentative locations) of installations within the position. For the battery, the commander also identifies the AoF.
- The commander traces routes to be used during the movement. He/She identifies potential trouble points along the route; e.g., likely ambush points or obstacles.
- Order of march.
- Potential emergency firing positions (during displacement).
- Convoy control measures.
- Time of movement.
- Security measures, including immediate actions and planned fires.
- Mission-oriented protective posture (MOPP) status and areas of known chemical or nuclear contamination.
- Any special instructions.

Administration and Logistics

Includes administrative logistical information; e.g., vehicle recovery, rations, water or fuel.

Command and Signal

- Prearranged codes and signals for the movement.

- Convoy communications; e.g., frequencies or net control restrictions.
- Location of key personnel in the convoy; e.g., commander or corpsman.

Battalion Reconnaissance Party

The battalion commander (or his/her designated representative) assembles personnel and equipment for the reconnaissance. Reconnaissance party composition varies with the mission and any restrictions that may apply. Normally, the party includes the S-3, S-6, and survey officer. The S-2 may accompany the commander to analyze security requirements or identify PAs for radars, OPs, etc. In some situations, battery commanders, survey personnel, wiremen, the ammunition noncommissioned officer (NCO), and a medical representative may accompany the battalion commander.

Actions Prior to Departure

Before leaving on the reconnaissance, the commander gives his/her XO as much information as he/she can to allow the battalion to continue operations and to prepare for movement during his/her absence. He/She may provide instructions for the issuance of the battalion order following the reconnaissance.

Reconnaissance Party in March Column

During a march with the supported unit, artillery reconnaissance parties usually precede artillery units and march with the advanced elements of the supported unit in column. The artillery commander can reconnoiter positions along the route, as necessary. If time is limited, the commander may have to proceed to the PA, conduct reconnaissance, select the position, and coordinate survey while the unit is on the march.

Conducting the Reconnaissance

The battalion commander normally assigns reconnaissance tasks to members of the party. On arrival at the potential PA, members accomplish their assigned tasks and reassemble at a specified

time and place. Tasks performed include selecting positions for the battalion headquarters echelons, routes, and communications sites. The battalion commander may identify battery PAs and battalion PAs for any reinforcing artillery. Alternately, he/she may give guidance and authorize subordinate commanders to select their PAs. He/She orients the units by assigning AoF or aimpoints. The battalion commander may also identify PAs for other artillery units under battalion control; e.g., CBR detachment. Following the selection of PAs, the battalion commander determines the method and order of movement.

Battalion Positioning

Based on the tactical situation and the position selection factors, the commander/S-3 may use the following positioning techniques.

Battalion Perimeter

Firing batteries are positioned near each other with the headquarters battery main echelon positioned central to firing batteries to form a battalion perimeter. This technique favors C3, coordination, survey, CSS, and local security. This technique is desirable when the threat has minimum detection and counterfire capability, in close terrain, and on a relatively static battlefield. The battalion is vulnerable to counterfire, radio and radar direction finding, artillery barrages, air strikes, and nuclear/chemical attack. Displacement of the battalion may be necessary if the position is discovered.

Battery Perimeter

Firing batteries are positioned in separate perimeters with the headquarters battery main echelon positioned where it can best control the battalion. C3, coordination, survey, CSS, and local security become proportionally more difficult with dispersion. Increasing dispersion is desirable when the threat has acquisition and counterfire capability, in open terrain, and on a relatively dynamic battlefield. The battalion as a whole is less susceptible to threat detection and

less vulnerable to threat attack. For short periods, a control cell (S-3, S-2, and essential equipment) may be required to extend the battalion's capability to maintain control.

Firing Positions Outside the Perimeter

A battery may also prepare firing positions outside its perimeter. The battery occupies the supplementary firing position with only the necessary personnel, equipment, and supplies for a specific mission; e.g. limited artillery raid, registration to the rear or offset registration. Following the mission, the battery or those elements conducting the mission return to their primary position. This technique can extend the range of the battery and reduce the threat's counterfire effectiveness. C2, CSS, and security are simplified since the elements of the battalion are usually together. However, the battalion's ability to deliver massed or sustained fire may be degraded when units are not outside the battalion position conducting other missions. Additional positions and routes, time, survey, and communications are required. The vulnerability of the battery while displacing must be considered.

Battery Positioning

Like battalion PAs, battery PAs are general in nature. Battery commanders reconnoiter their assigned PAs as part of the battalion commander's party or they may plan and execute their reconnaissance. When required, the battalion may assign a battery a position to occupy. In contrast to the battalion PA, the battery position is the specific location occupied or to be occupied by the battery; i.e., grid coordinates. This may occur when the battalion desires to positively control the positioning of artillery. Several factors affect selecting battery PAs as follows.

Control and Coordination

Disposition of the battalion on the ground will affect its overall capability to meet its fire support requirements and its survivability.

Supported Unit's Mission and Plans

Battery PAs should not interfere with other troops or installations. For example, in a movement to contact, areas should be positioned near roads to allow artillery to keep up with the fluidity and speed of the battle.

Firing Capability

Battery positions should be mutually supporting with at least 3,000 meters overlap in their firing capability fans. Other considerations include gun-target line, firing range, and capability to mass. Positioning that requires a battery to fire directly overhead of another battery should be avoided.

Threat Capability

Positioning will be influenced by the threat's capability and means to detect and attack artillery. Table 5-1 contains battery positioning techniques that correspond to threat types.

Table 5-1. Battle Positioning.

Threat	Battery Positioning
Radio direction-finding	Laterally to degrade this capability.
Counterfire	Minimum of 1,000 meters apart.
NBC	To minimize the effects and exposure to these weapons.
Air	Randomly and dispersed.
Ground	To take advantage of existing security of other units; for mutual support; outside range of threat long-range direct fire weapons.

Additional Positioning Considerations

Terrain

Terrain can limit availability of suitable firing positions as well as minimize detection and vulnerability to the threat's attack. A position can be selected against an embankment to afford

protection from air attack; a battery can be placed in a PA that has restricted armored vehicle access.

Combat Service Support

Artillery PAs should be road-accessible.

Communications

Communications within the battalion, as well as with the supported unit, should be considered when selecting PAs. When possible, the capability for wire communications should be made available.

Radar

When feasible, a radar should be positioned near one of the firing batteries to ease security and support. Generally, radars are positioned at least 1,000 meters from another unit to avoid increasing the vulnerability of the unit by the radar signal and vice versa.

Battalion Headquarters Echelons

The battalion headquarters echelons are located to allow effective C2 of the firing batteries and, at the same time, communications with the supported/reinforced unit. The battalion commander is located where he/she can best command the battalion.

The COC of the echelon where the commander is located is designated the battalion CP.

Main Echelon

The battalion commander selects the general PA for the battalion's main echelon, with the S-3's recommendation. Selection is made by map reconnaissance or, when possible, ground and/or air reconnaissance. This positioning is influenced by the positions of the firing batteries and the supported unit headquarters. The headquarters battery commander conducts a reconnaissance to determine the specific position of the main echelon and the location of the COC within that position. During displacement, main echelon personnel, vehicles, and equipment moving to and occupying the new position are temporarily designated the FWD echelon until control of operations has been assumed from the main echelon.

Rear Echelon

The S-3 selects the general PA for the rear echelon, RRP, etc., based on the S-4's recommendation. The S-4, or his/her designated representative, conducts a reconnaissance to determine the specific position for the rear echelon.

CHAPTER 6

FIRING BATTERY OPERATIONS

SECTION I. FUNDAMENTALS

Mission

The mission of the artillery firing battery is to provide timely, accurate fires for the artillery battalion in support of expeditionary/land-based MAGTF operations. In MEU operations, the artillery firing battery provides timely, accurate fires in support of the GCE.

Organization

The firing battery is the firing unit of the artillery battalion. It possesses personnel and equipment necessary to shoot, move, and communicate. Its organization includes a battery headquarters and one firing platoon. Figure 6-1 on page 6-2 depicts the sections within the battery. The table of organization (T/O) includes sufficient fire direction personnel to establish an FDC and a BOC. Each artillery cannon section has one howitzer, a prime mover, and crew.

Functions and Employment

Firing batteries normally operate as integral parts of the battalion. The firing battery is not normally assigned a tactical mission unless operating independent of the battalion. The firing battery can deploy independently when augmented with appropriate CSS personnel and when supported by the infantry battalion to which attached. It can also function as a provisional rifle company, if required.

Battery operations are normally conducted from a single firing position. The firing position includes

the firing platoon and sections of the battery headquarters, as required. The firing battery is capable of the following:

- C2 through the FDC and BOC.
- Providing artillery liaison personnel, FOs, and equipment to a supported unit.
- Performing limited maintenance support within the position.
- Maintaining ammunition and supply for sustained operations.

Duties of Firing Battery Personnel

Battery Commander

Under the guidance of the battalion commander, battery commanders will direct battery operations with responsibilities including, but not limited to, the following:

- Leading the advance party and conducting RSOP in accordance with MCWP 3-16.3.
- Ensuring coordination for survey requirements with higher headquarters or establishing hasty survey as required by the tactical situation or organizational structure.
- Directing the layout of positions.
- Ensuring survivability and advising the maneuver commander on all matters concerning the employment of artillery fires at this MEU (special operations capable [SOC]) level.

Executive Officer

The XO commands the firing platoon. He/She should be fully capable of assuming control of the battery

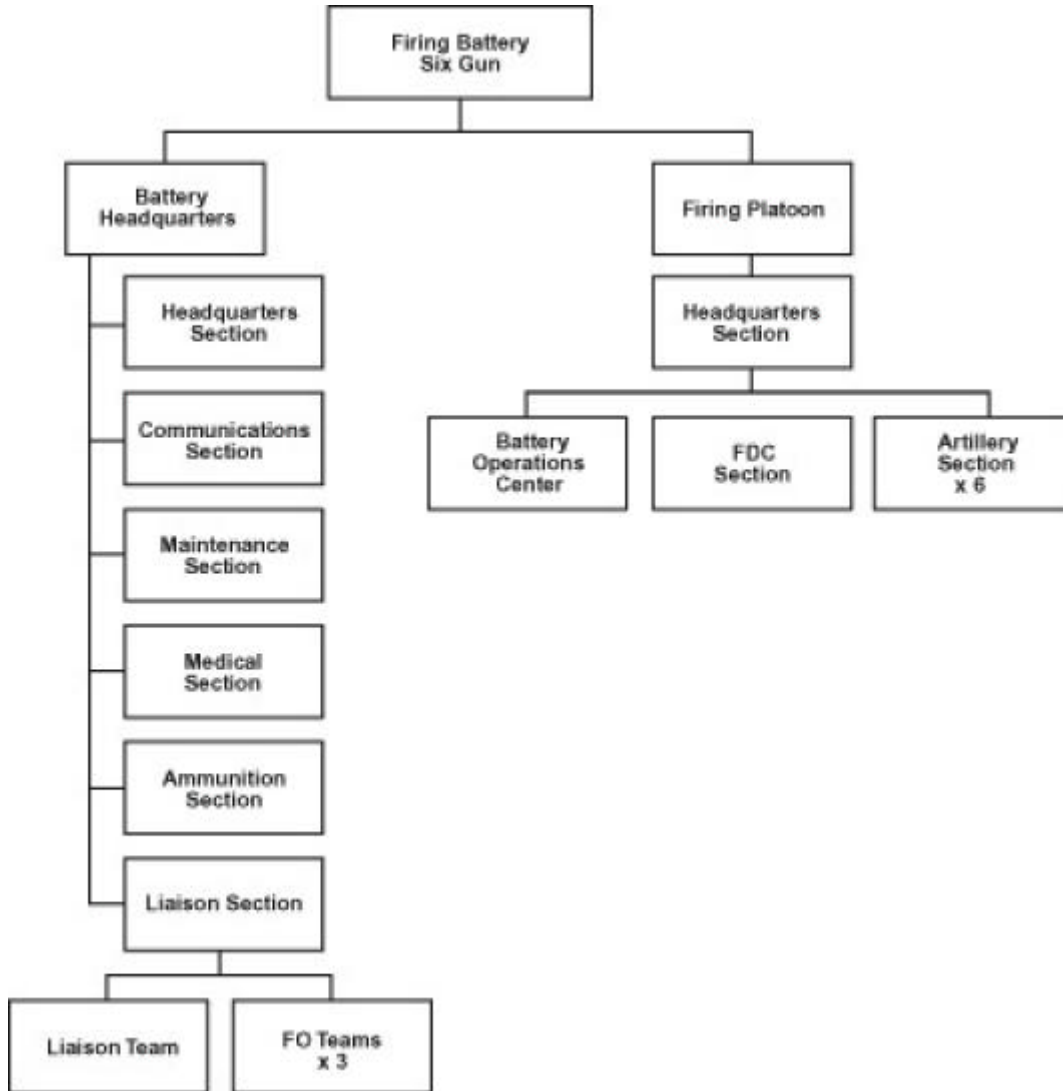

Figure 6-1. Firing Battery.

at any moment and should conduct RSOP for the battery whenever the battery commander is not available. In addition to being positioned where he/she can best control battery operations, the XO duties include, but are not limited to, the following:

- Supervise and coordinate logistical and maintenance efforts, including the distribution of all classes of supply.
- Act as liaison between the battery and logistical support agencies.
- Verify the lay of the battery.
- Ensure the accurate computation of XO's minimum quadrant.
- Establish and supervise the plan for battery defense.
- Direct howitzer operations and consult with the FDO on ammunition management.
- Lead the main body to the next firing position.

See MCWP 3-16.3 for more information.

Liaison Officer

The LNO serves as the battery CO's representative and artillery/fire support advisor to the supported maneuver battalion. Primary duties include keeping the artillery battalion/battery informed of the maneuver battalion's plans and monitoring/controlling the FO teams. He/She also participates in fire support planning and must constantly be aware of the location and situation of the artillery battalion and batteries. See MCWP 3-16 and MCWP 3-16.6, *Supporting Arms Observer, Spotter, and Controller*, for more information.

Fire Direction Officer

The FDO is responsible for the training and supervision of the fire direction personnel. The FDO is responsible for the following:

- Ensuring the accurate computation of firing data for the engagement of targets based on commander's guidance, attack criteria, and the tactical situation.
- Maintaining a SITMAP to reflect battlefield geometry and the current threat situation.
- Eliminating the potential of fratricide by clearing intermediate crests along the gun-target line.

See MCWPs 3-16.3 and 3-16.4 for more information.

Assistant Executive Officer

The assistant executive officer (AXO) assists the CO during RSOP and advance party operations. The AXO is responsible for setting up and orienting the lay circle using the most preferred method available. In the absence of the CO, the AXO selects the location for the BOC. Once the battery occupies and has been laid by the XO, the AXO assists the XO in the general supervision of the battery position. The AXO serves as the FDO in the BOC. See MCWP 3-16.3 for more information.

First Sergeant

The first sergeant is the senior enlisted advisor to the CO on administrative matters and the enlisted members of the battery. The first sergeant is guided in the performance of his/her duties by MCWP 3.16.3

Battery Gunnery Sergeant

The battery gunnery sergeant is the primary expert on artillery matters. He/She should be prepared to assume the duties of the XO if required. He/She assists the XO in the overall establishment and supervision of the plan for battery defense. The battery gunnery sergeant is guided by the duties assigned to the chief of firing battery in MCWP 3-16.3.

Operations Chief

The operations chief is the technical expert and trainer within the FDC. He/She ensures that all equipment is on hand and operational, maintains appropriate records, and supervises the computation of all firing data. He/She is responsible for the fire control map including the current location of friendly units and FSCMs. He/She ensures the smooth performance of the FDC and functions as the FDO in his/her absence. See MCWP 3-16.3 for more information.

Assistant Operations Chief

The assistant operations chief is the technical expert within the BOC. He/She ensures a technical fire direction method is available and in concert with the FDC's method (met, residuals, MVVs, etc.) before the BOC departs for the new position. He/She ensures equipment is on hand and operational, appropriate records are maintained, and supervises the computation of all firing data within the BOC.

Motor Transport Chief

The motor transport chief is responsible for vehicle support and maintenance for the battery.

He/She advises the CO/XO on convoy formations and procedures. Whenever possible, he/she develops strip maps to orient drivers and key personnel before movement. Additionally, he/she ensures vehicles are operational and receive routine maintenance.

Ammunition Chief

The ammunition chief reports directly to the XO for guidance. He/She is responsible for ensuring the correct amount of ammunition is received and delivered to howitzer sections as directed. He/She works in concert with the XO to ensure adequate ammunition is available and projects future requirements based on the current operational tempo.

Local Security Chief

The local security chief is responsible for recommending the local security efforts of the battery. He/She trains and supervises personnel in the employment of crew-served weapons. He/She accompanies the CO on RSOP and leads security sweeps by the advance party. When in position, he/she generates the battery defensive diagram and ensures it is reviewed by the XO and forwarded to the battalion for integration with battalion defensive plans. See MCWP 3-16.3 for more information.

Communications Chief

The communications chief is the principal advisor to the CO for all communications matters. He/She is responsible for establishing and maintaining battery wire diagrams and radio communications. He/She provides a representative for the advance party who is proficient in advising the CO on communications sites. He/She also trains communications personnel on establishing, protecting, repairing, and recovering internal battery and section wire.

Howitzer Section Chief

The howitzer section chief is responsible for maintenance, training, and safe operation of the howitzer section. He/She is an expert in the safe operation and employment of the howitzer including maintenance, handling of ammunition, local security, convoy operations, navigation, direct fire including the M-2 and M240G machine guns, MK-19, and emergency actions including the emergency destruction of his/her howitzer and prime mover. See MCWP 3-16.3 and the appropriate technical manual (TM) for more information on the duties and responsibilities of howitzer section chiefs.

SECTION II. FIRE DIRECTION

Firing Battery Procedures with the Battery Computer System

The FDC operates with the BCS as the primary means for technical fire direction and maintains a back-up capability. To the extent possible, the gun display units (GDUs) will be used by all howitzers to receive fire commands from the FDC; voice commands will be used as back up.

In conjunction with the digital wire link established between the BCS and the howitzer GDUs, a separate voice wire link will be established between

the FDC, the howitzers, and the BOC. An additional voice wire link will be established solely between the FDC and BOC. Before transmitting digital or voice firing data to the gun line, all firing data will be verified before firing. The howitzer section chiefs, BOC representative, and FDO will ensure constant monitoring of the wire link. See figure 6-2.

Gunnery

All techniques listed in MCWP 3-16.4 will be adhered to.

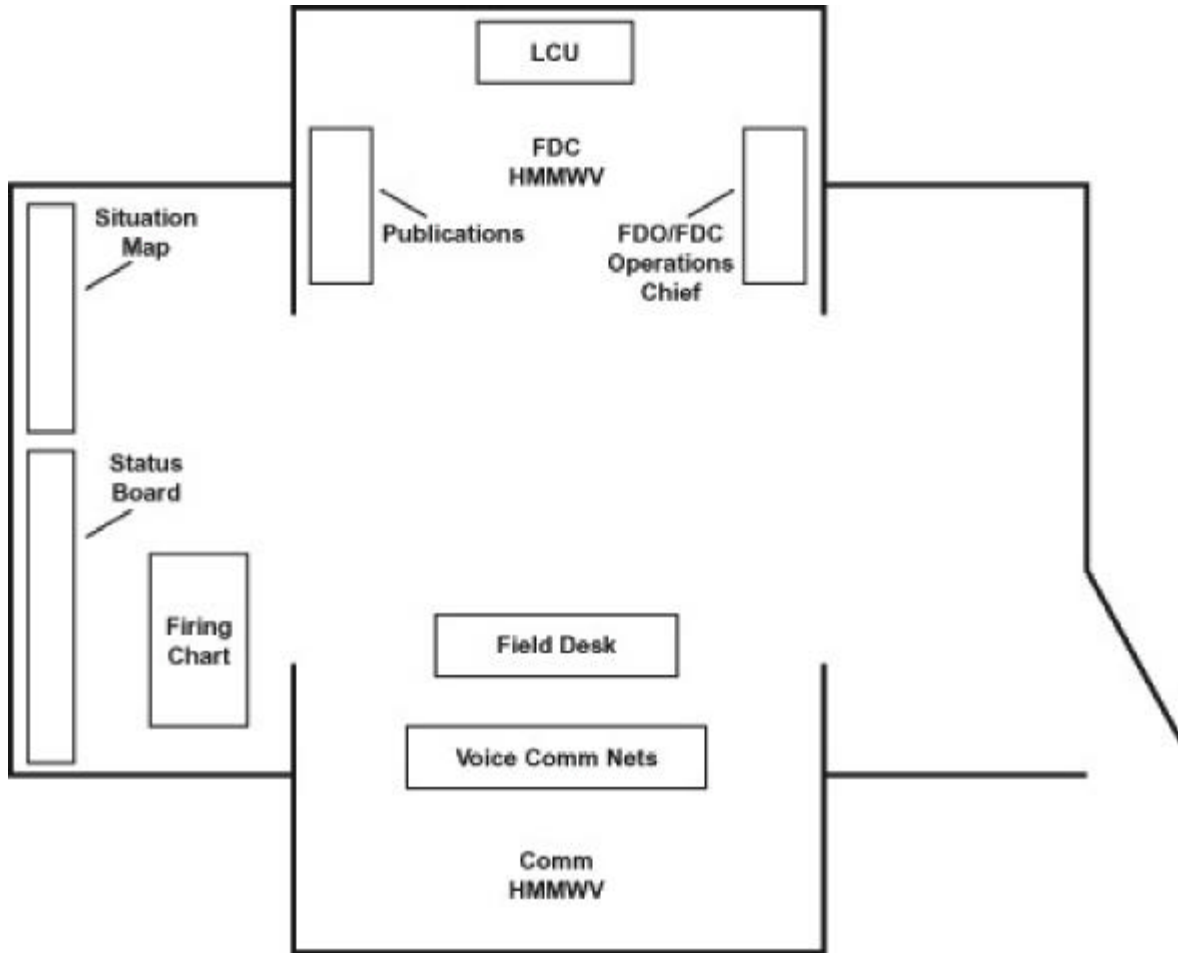

Figure 6-2. Example Battery FDC Configuration.

Fire Direction Center Functions

- Prevent fratricide.
- Determine residuals and graphic firing table settings.
- Respond to all communications directed to the battery.
- Compute technical data for firing element.
- Perform tactical fire direction, as required.
- Execute fire plans.
- Receive fire order standards from the battalion, when required.
- Establish fire order/command standards for the battery.
- Respond to fire orders from battalion.
- Process requests for fire from supported units.
- Submit requests for reinforcing fires to battalion, when required.
- Designate ammunition lots if not designated by higher headquarters.
- Issue fire commands to howitzer sections.
- Assign priority targets/FPF to firing battery.
- Submit reports to battalion.
- Maintain an FDC journal.
- Maintain a fire control map to keep track of friendly and threat positions, tactical control measures, FSCMs, and zone of fire/target area in the respective AOR.
- Be prepared to assume control as the alternate battalion FDC, if designated.

Fire Direction Center Journal

An FDC journal will be maintained in each FDC to record pertinent data to include the following:

- FSCMs.
- Summary of tactical situation.
- Future plans, if known.
- Current ammunition status and lot designations.
- Current fire order/fire command standards.
- Fire plans to include target lists and schedules.
- ROE.

- Applicable reports; e.g., DISREP, CPREP or NBC.
- Current residuals and graphical firing table settings.
- Met messages.
- Important messages.

Standards

Fire order standards and fire command standards are established by the respective FDO based on commander's guidance, tactical situation, and attack criteria.

SECTION III. BATTERY OPERATIONS CENTER

Purpose

The BOC is designed to send a fully mission capable sub-unit of the battery forward with the advance party to rapidly achieve fire capability upon arrival of the firing element at a new position. The BOC also serves as an alternate FDC in the firing position in the event the battery FDC experiences severe degradation or catastrophic loss of C3 or possibly when the battery FDC assumes control of the battalion FDC.

the road march, the BOC monitors battalion fire direction and battery command nets.

Once the howitzers with the advanced party are fire capable, the BOC requests passage of control from the battery FDC. The FDC transmits a DISREP to the battalion FDC upon displacement of the main body.

The BOC transmits a FIRECAP to the battalion FDC once passage of control from the battery FDC to the BOC is complete. This is due to the change in the number of howitzers now fire-capable.

Passage of Control

The passage of control from the FDC to the BOC will follow the procedures outlined in chapter 2 similar to forward and main at the regiment and battalion level.

The FDO transmits an updated FIRECAP to battalion accounting for the number of guns displacing with the advance party/BOC. During

Passing Control Back

Passing control back to the FDC uses the same procedures. If howitzers become fire-capable prior to the battery FDC assuming control back from the BOC, the BOC transmits an updated FIRECAP to the battalion FDC illustrating a change in weapon strength. Control from the BOC to the FDC is conducted via the most efficient means (wire or battery command).

SECTION IV. GUN LINE PROCEDURES

Purpose

Proper gun line procedures are essential to provide timely, accurate artillery fires in support of the maneuver element. The following paragraphs contain common techniques and procedures.

Special Missions

When firing special missions, it is vital that all procedures on the gun line are clearly understood and followed.

Priority Target

- Lay on priority target data at the end of each mission.
- Prepare, segregate, and identify designated ammunition and powder.

Final Protective Fires

- The gun line will lay on FPF data at the end of each mission.
- Preferred ammunition for the FPF is high explosive/fuse quick (HE/Q) unless otherwise dictated by the FDC.
- Howitzers will be fired at their maximum rate of fire for 3 minutes followed by their sustained rate of fire until the command “cease loading” or all prescribed ammunition is expended.

Fire Plans

When operating in an automated environment, fire plans will be transmitted via GDUs. If time permits, a dry-fire rehearsal will be conducted prior to the actual schedule of fires being initiated. If GDUs are not operational or when conducting degraded operations, the following are proven practices:

- The operations chief or FDO records all fire commands on a 5” x 7” card by line number and submits to each section chief.
- The operations chief or FDO talks directly to the section chiefs via the voice wire link and passes the aforementioned data so it may be recorded by the gun line.

Regardless of the method used, section chiefs will ensure designated ammunition and powder are prepared and segregated by fire plan/series name.

Direct Fire

Direct fire is fire delivered on a target by use of direct-laying techniques. Direct fire is usually in conjunction with an emergency displacement, taking only essential gear.

Out of Traverse

See applicable weapon’s TM.

SECTION V. MOVEMENT AND POSITIONING OF THE FIRING BATTERY

Reconnaissance

After receiving a warning order or movement order by the battalion, or on his/her own initiative, the battery commander reconnoiters new firing positions. He/She plans the reconnaissance; conducts a preliminary map, ground, or air reconnaissance of the PA; returns to the battery, preferably on an alternate route; and briefs key battery personnel; e.g., the battery XO, first sergeant, battery gunnery sergeant or local security chief. The first sergeant assembles the reconnaissance party. In some situations, the battery commander may decide to bring an advanced party on his/her reconnaissance. If the battery commander is conducting the reconnaissance as part of the battalion commander's recon-naissance party, the battery commander (and his/her reconnaissance party) will meet the battalion commander at the appointed place and time.

Reconnaissance Tasks

The battery commander leads the reconnaissance party (and advanced party) to the new position. He/She selects locations for battery installations, formulates the occupation plan, issues orders, and supervises the execution of the plan. During the reconnaissance, the commander may sketch the route and general layout of the position. The sketch is useful for briefing key personnel on the movement and helps orient personnel on arrival at the position, especially at night. Navigation can be aided by annotating the route with mileage and time marks. Tasks performed during the reconnaissance include the following:

- Route suitability, primary and alternate.
- Trafficability of the route and position, bridge classifications.
- Obstacles and possible ambush sites.

- Positions for emergency occupation (hip shoot).
- Security along route and defensibility of position.
- Control measures to facilitate movement.
- Battery positions and AoF.
- NBC contamination.
- Availability/accuracy of survey using an aiming circle or compass to check the grid azimuth to the EOL.
- Time and distance requirements.
- The order of march.
- Battery CSS area for ammunition and maintenance, if necessary.
- Cover and concealment.

Selecting the New Position

The battery commander selects the firing position and, if needed, a separate battery CSS area. If assigned a battery PA by the battalion, the battery commander reconnoiters the area to locate suitable positions for his/her battery. If a battery PA is not assigned, the battery commander positions the battery to meet the following considerations.

Firing Position Characteristics

The essential characteristic of a firing position is that it permits the unit to accomplish its mission. Operations should not be delayed by seeking a perfect position. A desirable firing position should do the following:

- Allow all weapons to deliver fire for maximum coverage of the supported unit.
- Afford defilade and concealment from ground observation. Minimize observation of muzzle flash by defilade. Too much defilade may limit the field of fire of the weapons in close defense of the position against ground attack or may restrict low angle fires.

- Be free of obstructions which affect the firing capability of a howitzer; e.g., a cliff, building or high tree to the flank.
- Allow for 6400-mil firing capability.
- Be accessible and have separate routes for entrance and exit, preferably in the rear. The position should not be on a threat high speed avenue of approach. Concealed routes to and from the battery are desirable, particularly if the position will be occupied and resupplied during daylight. Close proximity of a helicopter landing zone (LZ) is also desirable.
- Be on relatively level, firm ground. Very rocky, swampy, sandy or uneven ground will slow the occupation of the position or prevent the effective operation of the weapon. The position should be trafficable by all vehicles in the battery. Current and anticipated weather, e.g., rain, flash floods, snow, should be considered.
- Be in small trees, in brush or in isolated open spaces or irregular clearings in vegetated terrain. Good positions can often be found along the edge of a road or trail, but away from crossroads or junctions that may attract hostile artillery fire. Also, the battery should not be along the edge of a primary route for supply. Positions at the forward edge of a treeline, in small clumps of woods or under a solitary line of trees are easily spotted by the threat.
- Be away from prominent landmarks when positioned in open terrain. The unit should be randomly dispersed over the ground, making good use of contours.
- Be in quarries, in ruins or under the roofs of buildings in a town.
- Allow for good communications, preferably by wire, with the supported unit and higher headquarters.
- Be large enough for dispersal of weapons and other installations if there is an air or counter-battery threat.
- Be in a compact, easily defended position in mountains or heavily wooded areas; when friendly forces have air superiority; or when the battery is threatened by guerrilla or infiltration tactics. The battery position should be away from threat-concealed routes of approach.
- Allow for shelter and comfort of the battery personnel.
- Have survey control established or survey available in a short time. Hasty survey may be required.
- Be selected in consideration of the battery's future mission or displacement.

Types of Positions

The battery commander selects primary, alternate, and supplementary positions. These positions are selected to support the planned operation of the supported unit. However, the battery must remain flexible and ready to displace in any direction in case the operation, mission or tactical situation changes.

Primary

A primary position is the position from which the unit will accomplish its assigned tactical mission.

Alternate

An alternate position is the position to which the unit will move and accomplish its assigned mission should the primary position become untenable. The alternate position should be generally 800 to 1,300 meters away from the primary position. This separation allows the unit to escape the effects of threat indirect fire on the primary position, but close enough for rapid displacement. An alternate position should be selected for each primary position. The alternate position must have the same characteristics as the

primary position. It should be reconnoitered and prepared for occupation as time permits. Each section chief must know the route to the alternate position because movement to that position may be by section.

Supplementary

A supplementary position is a position selected for the conduct of a specific mission, such as an offset registration, a special fire mission, adjustment with a roving gun or defense of the primary position. Supplementary positions for howitzers should be selected to cover likely threat avenues of approach in the battery defense. Positions for offset registrations and roving guns should be far enough away that counterfire will not affect the primary positions.

Advance Party

An advance party is a group of unit representatives dispatched to a planned new position in advance of the main body to prepare the position for the arrival of the unit and its equipment. A good advance party is critical to timely and orderly occupation of positions. Personnel in the advanced party should be trained, competent, and capable of accomplishing assigned tasks with little or no supervision. When possible, the advance party should have regularly assigned personnel for continuity and consistency in advance party operations.

Composition

Composition of the advance party is usually stated in the unit SOP and is changed based on the tactical situation and assets available. Figure 6-3 lists minimal assets for an advance party.

Personnel	Equipment
Battery commander, first sergeant, and driver	Vehicle with radio, map, compass, chemical, and nuclear detection equipment.
Local security chief	Map and materials for preparing defensive diagram, aiming circle, and necessary wire-communications equipment.
Battery operations center	Fire direction and communications equipment as necessary.
Gun guides	Compass, wire-communications equipment, and section gear necessary to prepare howitzer position.
Communications personnel	Necessary equipment to establish initial communications.

Figure 6-3. Advance Party.

Assembly of the Advance Party

The battery gunnery sergeant or local security chief assembles the required personnel and equipment for the advance party and ensures equipment is operational. He/She coordinates security for the movement and for occupation of the new position. The commander briefs key personnel of the advance party. The unit SOP should have a prearranged signal or procedure that will specify the personnel, equipment, vehicles, their sequence in the march column, and the place of assembly.

Firing Capability

Depending on the mission and tactical situation, the commander may take a howitzer section with the advance party.

Taking a firing capability forward confuses threat moving-target-locating radars, as part of the infiltration plan. It also confirms suitability of the route and firing position when conditions are doubtful,

and allows for conduct of a registration or an offset registration if use of BCS or BUCS-R is lost.

Advance Party Tasks

On arrival at the new position, the advance party halts and security personnel sweep and secure the battery position under the supervision of the local security chief. Security personnel move through the position and the surrounding terrain to ensure the area is clear of threat personnel, boobytraps, mines, and NBC hazards. As the sweep is completed, personnel begin preparing the position for occupation. The extent of the preparation is time-dependent; as much work as possible is done before the arrival of the main body. As tasks are completed, a hasty local security is established. Vehicle ground guides await the arrival of the battery at the pickup point. Advance party operations tasks include the following:

- Conduct a security sweep of the new position to secure outside perimeter.
- Concurrently position MK-19's along the most likely high speed avenue of approach and position an M2 machine gun along the long axis covering the new position.
- Once the position is secure, the CO, with assistance of the local security chief, selects positions for each howitzer, the FDC, the antennae farm, and the battery's logistics elements.

The battery commander—

- Designates the azimuth of fire, if necessary.
- Selects positions for howitzers, aiming circles, FDC, BOC, and other installations.
- Provides guidance to the local security chief on the plan of defense.
- Provides instructions on preparing the position to the guns platoon sergeant.
- As time permits, reconnoiters alternate and supplementary positions.
- Supervises the preparation and occupation of the position.

See figure 6-4 on page 6-12 for an example of a battery commander's position checklist.

The assistant executive officer assists the battery commander in organizing the battery position and establishes the BOC. Duties include the following:

- Set up and orients the aiming circle.
- Determine initial deflections, subtense, and vertical angles (VAs) from the aiming circle to the guns.
- Supervise the establishment of wire communications with each howitzer position, FDC, and BOC.
- Lay howitzers, if applicable, and prepare the XO's report.
- Provide a vehicle guide to guide FDC vehicles of the main body into position.

The battery local security chief plans the battery defense. Duties include the following:

- Establish the track plan and vehicle dispersal area.
- Plan and rehearse the occupation with vehicle ground guides.
- Begin constructing a defensive diagram.

The acronym **SPEARR** may be used to assist in the conduct of the advance party.

- **Security**—A security sweep of the position is conducted.
- **Position**—Positioning of the battery's assets will be determined by the CO or local security chief. Gun guides will tape and stake their firing positions and ensure howitzer marking stakes are placed appropriately (with M14 Pantel light on at night).
- **Establish Communications**—Wire communications are established within the position using DR-8s and H-200s. Hand-and-arm communications or radio communications may be used as a back-up.
- **AoF/initial deflection, subtense, and VA**—Once communication is established, howitzer ground guides report to the aiming circle to receive initial deflection.
- **Record**—Ground guides record initial deflection.
- **Reconnaissance**—Ground guides walk their track plan from howitzer position to pick-up/release point and await main body arrival.

Mission Accomplishment.	
<input type="checkbox"/> Can the battery provide support from the selected position? (This must be the overriding factor in determining position suitability.) <input type="checkbox"/> Designate alternate and supplementary positions.	
Size of Area.	
<input type="checkbox"/> Is the selected position large enough to allow all battery equipment to be adequately dispersed?	
Terrain Considerations.	
<i>Defilade</i>	<i>Concealment</i>
<input type="checkbox"/> Protection from ground observation <input type="checkbox"/> Protection from direct fire <input type="checkbox"/> Protection from indirect fire <input type="checkbox"/> Terrain masking for antennae	<input type="checkbox"/> Natural <input type="checkbox"/> Supplemental (manmade) Disposal <input type="checkbox"/> of empty canisters/dunnage
<i>Trafficability</i>	<i>Access Routes</i>
<input type="checkbox"/> Suitability of road surfaces <input type="checkbox"/> Inclement weather plan	<input type="checkbox"/> Concealed, preferably from rear of position <input type="checkbox"/> Dual routes
Survivability. Use combination of all methods to ensure maximum survivability.	
<i>Threat.</i> Prioritize most likely enemy threat to battery based on the S-2's analysis of enemy weapons and target acquisition capabilities.	
<input type="checkbox"/> Ground attack <input type="checkbox"/> Air attack <input type="checkbox"/> Counterfire	
<i>Dispersion</i>	
<input type="checkbox"/> Maximum feasible distance (based on threat analysis and terrain). Goal of 100 meters between howitzers in a high counterfire threat environment. Disperse both laterally and in-depth. <input type="checkbox"/> FDC/antennae remotored to maximum feasible distance. Goal of 750 meters in a high EW threat environment.	
<i>Hardening</i>	
<input type="checkbox"/> Something is better than nothing. <input type="checkbox"/> Minimum. Protection for personnel (fighting holes) and ammunition.	
<i>Survivability Moves</i>	
<input type="checkbox"/> Must be completed as quickly as possible to reduce out of action time. <input type="checkbox"/> Move at least 1,000 meters.	
<i>Defensibility</i>	
<input type="checkbox"/> Likely ground avenues of approach identified. <input type="checkbox"/> LPs/OPs and engagement areas established along likely avenues of approach (should be far enough to permit hasty displacement to supplemental or alternate positions). <input type="checkbox"/> Indirect fires planned from mutually supporting positions on likely ground avenues of approach. <input type="checkbox"/> Defense diagram prepared integrating all crew-served weapons, howitzers, individual weapons, and LPs/OPs. <input type="checkbox"/> Supplemental direct fire positions identified. <input type="checkbox"/> Range cards prepared for all howitzers and crew-served weapons. <input type="checkbox"/> Patrols established and coordinated. <input type="checkbox"/> Reaction force established and mustering point identified. <input type="checkbox"/> Emergency signals established.	
<i>Miscellaneous</i>	
<input type="checkbox"/> Distant aiming point identified and referred deflections recorded (at least 1,500m, preferably to the flank, and visible at night). <input type="checkbox"/> Verify BCS/BUCS-R computed howitzer locations with PLGR or Map Spot. <input type="checkbox"/> Utilize hasty astro or simo to confirm directional control. <input type="checkbox"/> Verify ammunition lots and coordinate emplacement of M94 chronograph with FDC.	

Figure 6-4. Example Battery Commander's Position Checklist.

Establishing communications should not delay this procedure. Voice or hand-and-arm signals are used as a back up.

Organizing the New Position

Organizing the new position consists of those actions necessary to allow the battery to deliver fire. Organization is a continuous process that begins during RSOP and ends when the position is vacated. During RSOP, the advance party conducts those actions necessary for the immediate delivery of fire. When the battery's main body arrives, actions are taken for the delivery of continuous fire and the position improved. The longer a unit remains in a position, the more the position is improved.

Movement of the Main Body

Displacements may be directed by higher headquarters or by the battery commander, depending upon whether control is centralized or decentralized. In all cases, the battery must promptly submit a DISREP to its immediate, higher headquarters when displacing. Units must develop and rehearse procedures for control measures, immediate action, and signals to improve tactical march techniques. See MCWP 3-16.3 and MCRP 4-11.3F, *Convoy Operations Handbook*.

Planning the Move

The CO must determine which of the four methods of march to use, based on the tactical situation:

- Open column.
- Closed column.
- Infiltration.
- Terrain march.

The XO gives his/her movement order brief to the FDO, gunnery sergeant, section chiefs,

motor transport chief, communications chief, ammunition chief, and all remaining vehicle operators. Adequate security measures for movement include, but are not limited to, the following:

- Concealment along the route.
- Air sentries posted. The convoy's direction of movement will be established as 12 o'clock. Assistant drivers will be responsible for the 10 to 2 o'clock sector. The two Marines located at the rear of each vehicle will cover the 2 to 6 and 6 to 10 o'clock sectors. With 5-ton trucks equipped with a mounted M2 machine gun or MK-19, the assistant driver will cover a 360-degree sector.
- Distribution of machine guns and ring mounts throughout the convoy.
- NBC detecting and monitoring equipment is located with the lead howitzer section.
- Night vision goggle distribution and functioning.
- Convoy maintaining appropriate dispersion.

Other Considerations

Key personnel should be dispersed throughout the convoy with radios for adequate control and to provide enhanced survivability.

The motor transport chief, a mechanic, and a truck without a towed load will be posted at the rear of the column.

Normally, a corpsman will be located in the convoy (typically the battery gunnery sergeant's vehicle).

Conducting the Move

These specific checks should be conducted before the move:

- Ensure the order of march is known by everyone.
- Ensure vehicles are operationally safe and have adequate fuel.
- Establish communications on battery command/convoy frequency.
- Employ vehicle guides to lead vehicles through terrain, occupied positions or when backing up.

Upon the XO announcing “close station march order” (CSMO), battery sections will—

- Strike nets.
- Load all section equipment onto the section vehicles.
- Check vehicles for proper operation.
- Account for all personnel, section equipment, and weapons.
- Prepare for movement. Movement will be initiated by the XO’s vehicle departing the position. All vehicles will follow, in the prescribed march order, from their individual locations within the position.
- Enforce march discipline.
 - Keep moving.
 - Relay all signals.
 - Practice light/noise discipline.
 - Maintain convoy speed.
 - Maintain vehicle interval.
 - Keep alert with weapons outboard.
 - Wear helmet/flak jackets.
- Continually estimate location while on the move by using odometer, terrain features, route markers, check points, PLGR, etc.

Occupying the Position

The objective of the occupation phase of RSOP is to prepare to deliver fire. The battery is extremely vulnerable during this phase. Thus, the occupation must be rapid, orderly, and quiet. Occupations are enhanced by a well-established SOP, training, and a well-prepared position.

Deliberate Occupation

On arrival at the position, vehicles move into the position without halting or closing the interval between vehicles. Vehicle ground guides lead their

assigned vehicle from the pickup point to the appropriate location for unloading and/or parking.

Laying of Howitzers

The unit can deliver fire when howitzers are laid. Various methods are available to meet the needs of the situation. Detailed procedures for laying are discussed in MCWP 3-16.3. Reciprocal laying of aiming circles or howitzers can overcome LOS problems and expedite laying.

Security

Each section must have a predetermined sector of responsibility during the occupation. If the howitzer sections are dispersed over great distances, each section becomes responsible for its own defense until help arrives. As the unit settles into position, the security and defensive plan of the battery are formed.

Position Improvement

An order of work is established based on the threat and the time that the unit is in position. The commander may establish an order of work as follows:

- Harden critical items of equipment.
- Prepare individual fighting positions.
- Establish security measures.
- Develop defensive plan.
- Prepare alternate position.

Hasty Occupation

In some situations, there may not be enough time to prepare positions for occupation. Priority of tasks are established to ensure the following:

- Selection of howitzer positions.
- Set up of aiming circles.
- Preparation of howitzer positions, to include placing panoramic telescope and marking stakes, and recording initial deflections.
- Minimum essential internal wire communications.

The commander selects the position and designates the AoF. Gun guides select howitzer positions. The commander guides the entire unit into position. Vehicle ground guides then meet their vehicle as it approaches their positions. The AXO and battery gunnery sergeant conduct their normal duties as time permits.

Howitzers are laid using the most expeditious means. If wire communications are not available, voice commands are relayed from the aiming circle to the gun line. The situation may require firing to commence before making tests and adjustments. Firing data is determined using the most expeditious means. The FDC/BOC initially should be set up close to the gun line so that fire commands can be relayed by voice.

As time allows, action is taken to organize and improve the position. Any inaccuracies in laying or boresighting are corrected. Communications within the unit are improved and normal installations are established.

Night Occupation

Night occupation reduces the unit's vulnerability to detection during occupation. However, night occupation must be smooth and orderly to avoid chaos, damage and loss of equipment or injury to personnel. Night occupation is slower than a daylight occupation. Light and noise discipline must be stressed. Night occupation is ideally conducted following a daylight preparation, or following a night preparation. Should daylight preparation be impossible, night vision devices are vital.

Vehicle Ground Guides

Guides must know their routes and the order of march. Guides should walk their routes carefully before dark and at dusk, if possible, noting paces and features to assist navigation. As each vehicle approaches the pickup point and is recognized; a threat vehicle may have infiltrated the column, the guide leads the vehicle into the position. Vehicle blackout marker lights should be turned off. If the driver does not have night vision

goggles, the guide carries a flashlight with a filtered lens. If the driver fails to see the guide/light for some reason, he/she should halt immediately; i.e., the guide may have fallen down. When the vehicle arrives at its designated position, the guide signals the vehicle to halt. Talking should be kept to a minimum.

If the guide does not have night vision goggles, he/she must rely on his/her night vision skills. The use of silhouettes on the skyline— e.g., a tall tree or the tip of a mountain—can help the guide maintain his/her orientation as he/she guides the vehicle into position. Navigational markings may be emplaced at key points; e.g., engineer tape, chemlights or a branch.

Unit SOP should establish a technique for vehicle recognition. Example: A blink of a color-coded flashlight by the assistant driver.

Lighting Devices

The advance party emplaces lighting devices on marking stakes, aiming posts, and instruments needed for laying; e.g., aiming circle. Unit SOP should establish procedures to ensure the correct reference light is sighted when using fire control and laying instruments at night; e.g., blinking lights in accordance with prearranged signals or using color-coded lights. During laying, only the aiming circle and the weapon being laid should have lights on. Too many lights cause confusion and destroy light discipline. At night, keep the laying instrument sighted on one piece until it is completely laid. The EOL is placed at sufficient distance to eliminate the possibility of parallax in the aiming circle. Parallax is the apparent displacement or the difference in apparent direction of an object as seen from two different points, not on a straight line with the object.

Loading and Unloading Equipment

Rapid displacements and night movements make it imperative that uniform load plans are established. The weapon position should be so organized that each Marine knows where each item of equipment is located at all times.

Emergency Occupation (Hip Shoot)

An emergency occupation results when a call for fire is received while the battery is making a tactical movement. The convoy leader (normally the XO) must know his/her location exactly during the road march and constantly select possible emergency firing positions by map and visual reference.

When a call for fire is received, the FDO or operations chief authenticates, if necessary, and relays the target call for fire target location to the XO (or designated convoy leader) on appropriate net.

The XO signals the convoy; selects the firing position and designates the AoF; passes the coordinates and AoF to the FDC personnel; and lays the unit in the following order of preference: aiming point-deflection, grid azimuth, and howitzer back-lay methods.

The FDO computes initial data and announces all fire commands. Communications within the battery is by small-unit transceiver (if available) or by voice relay. Aiming points are established in the following precedence, if terrain permits: distance aiming point, collimator, and aiming posts. On completion of the mission, the unit moves on or continues position improvement.

Local Security and Patrolling

Refer to chapter 4 of this publication.

Hasty Displacements

A hasty displacement is defined as an expeditious displacement by a unit due to an imminent attack by the threat.

Sections displace with all gear except ammunition/dunnage that is left in place.

On command to hasty displace, advance party personnel immediately report to the advance party vehicle. Section chiefs ensure that all gear and equipment are consolidated on or near the vehicle for quick displacement. Section chiefs

also ensure their drivers immediately check their vehicles and radios for proper operation.

Ammunition/dunnage are left on the deck for pick-up by service elements.

The order of march for the advance party does not change.

The order of march for the firing element is dictated by particular gun positioning and direction of exit from the gun position.

The standard time limit for a hasty displacement for the advance party is 4 minutes during daylight and 6 minutes at night.

The standard time limit for a hasty displacement for the firing battery element is 8 minutes during daylight and 12 minutes at night.

Service elements have 30 minutes—day or night—to enter into the new position with all ammunition/dunnage.

Emergency Displacement

An emergency displacement is defined as the urgent displacement of a unit while under attack. Units *must* bring only mission-essential gear, including howitzers with the equipment to achieve firing capability, and personal equipment (782 gear, NBC gear, and T/O weapon).

Each section displaces to the established rally point when ready. There is no order of march.

Advance party personnel remain with their sections until they arrive at the rally point.

At the rally point, personnel and ammunition are re-oriented, re-organized, and re-distributed. The advance party assembles at the advance party truck.

The standard time limit for an emergency displacement is 4 minutes during daylight and 6 minutes at night.

CHAPTER 7

FORCE ARTILLERY

Force artillery is not a new concept to the Marine Corps. It existed until the late 1970s as the field artillery group, as part of the force troops element of the Marine Amphibious Force. It belonged to Fleet Marine Force, Pacific, and Fleet Marine Force, Atlantic, respectively. Marine Corps force structure reviews from 1970 to the early 1980s gradually reduced the size of the field artillery group and the force troops. The remaining force troops were incorporated into a division in 1978-1979 with no additional reduction in size. By 1989, all artillery assets were consolidated in the GCE, leaving no organic GS artillery or artillery headquarters to support the MEF commander.

When the MEF emerged as the Marine Corps' primary warfighter in the late 1980s, the lack of force artillery became an issue. In 1996, I MEF established the 14th Marine Artillery Regiment as the force artillery for its major theater of war operation plans. This action was taken to counter I MEF's widely recognized shortfall in artillery (relative to threat artillery capabilities) and to create the capability to C2 MEF-level "force" artillery in operation plans requiring multiple division maneuver elements.

Mission

Force artillery provides the MEF with an artillery capability and a MEF-level artillery headquarters to C2 all cannon/rocket artillery units not assigned to the GCE. This provides the MAGTF commander with all-weather, surface-to-surface deep fires to support MEF deep battlespace fire support requirements; fires to reinforce the MEF close battle; and an effective MEF-level counterfire capability.

Concept of Employment

Force artillery provides the MEF commander the ability to directly influence the battle by providing all-weather, responsive fire support. The MEF commander's employment of the force artillery is based on METT-T analysis. In many cases, force artillery weapons and systems capable of ranging the MEF battlespace will be retained in GS of the MEF, though they may be positioned within the division's zone. Force artillery can augment the division's indirect fire capability by weighting the main effort, or shaping the battlespace to set favorable conditions for future operations. Force artillery may temporarily attach battalions to other artillery organizations but normally supports the MEF commander's intent through standard and non-standard tactical missions.

Tasks

Force artillery provides the MEF commander the means to effectively exercise C2, logistics, and administrative functioning over all MEF-assigned cannon/artillery units not dedicated to supporting the GCE. This includes, but is not limited to, all attached United States Army, allied, and coalition indirect fire support assets, as well as survey, met, and CBR teams and associated/dedicated CSS, as required. Force artillery does not control assets other than those that are organic or attached to it. Division artillery assets remain under the exclusive control of the division for use within its zone. In addition to the tasks normally associated with a Marine artillery regiment, force artillery must do the following:

- Provide C2 of attached United States or coalition artillery (cannon, rocket or target acquisition).

- Provide liaison to the MEF for FFCC information flow; provide input/brief as required in MEF updates and target boards; participate in the planning effort in future operations and G-5 plans operational planning teams; and to coordinate logistics, intelligence, and personnel requirements.
- If possible, provide personnel augments to the FFCC.
- Provide the MEF commander with the radar employment plan that covers the MEF single battle concept. Force artillery does not control the organic GCE radars of the artillery regiments, but coordinates the complete radar employment plan in the MEF zone by covering gaps in the division, joint, allied, and coalition zones identified through a METT-T analysis. This will enable the force artillery commander to focus long-range radars on MEF high payoff targets.
- Position the TPC for optimum counterfire support functions and communication with the force artillery's FDC, FFCC, and the Marine tactical air command center (TACC) or its extension agencies' forward air controller (airborne) (FAC[A]), strike coordination and reconnaissance (SCAR) or tactical air coordinator (airborne) (TACC[A]).
- Coordinate target acquisition/collection management requirements with the MEF G-2.
- Establish connectivity with the GCE artillery regiments, the aviation combat element (ACE), the CSSE, and MEF FFCC to support the counterfire fight, as required.
- Establish liaison teams with adjacent or attached joint, allied, and coalition artillery units.
- Plan for and coordinate logistical support for all force artillery attached units.

Command Relationships

The command relationship between the force artillery and the MEF is specified in the operations plans. The force artillery commander normally reports as operational control to the

MEF commander and may be designated as a major subordinate command. The force artillery will maintain organizational flexibility to facilitate future operations and continue to evaluate its task organization, providing recommendations on organization for combat to the MEF commander based on the tactical situation.

Force artillery and subordinate elements can execute any of the four standard tactical missions that could be assigned to any artillery unit. Assignment of tactical missions will be based on METT-T and artillery organization for combat.

Liaison

Force artillery provides liaison to the MEF, to division artillery forces that are part of the MEF task organization and, when appropriate, to the rear area operations group. Additional liaison may be provided to artillery units adjacent to the MEF. Normally, liaisons will be deployed capable of communicating with the force artillery without communications support from the unit to which assigned. However, external communications support may be required based on the mission. Depending on the tactical mission, operational tempo, and personnel requirements, the force artillery may task its organic battalions to provide all, or any part of, their battalion liaison teams to execute any force artillery tasking. This tasking may include, but is not limited to, providing a force artillery liaison team to a reinforced joint, allied or coalition unit. The MEF force artillery liaison activities ensure the following:

- Mutual cooperation and understanding between commanders and staffs of different headquarters.
- Coordination on tactical matters to achieve mutual purpose, support, and action.
- Coordinate and/or monitor execution of force artillery missions.
- Monitor current status of force artillery units.
- Assist in the coordination of the counterfire efforts of the MEF.

The MEF force artillery liaison team provides—

- Personnel to the MEF commander to augment FFCC, future plans, and future operations.
- Liaison to G-sections, as required.
- Guidance to the MEF commander/FFCC on capabilities and limitations of force artillery.

Force Artillery Intelligence Section

The intelligence section of the force artillery will play an important role in fusing the targeting data produced by the TPC with the intelligence information/reports generated by MEF intelligence assets. The primary tool for processing intelligence data is the intelligence analysis system, under the supervision of the MEF G-2.

The force artillery intelligence section will coordinate closely with the MEF G-2 to ensure the best possible exchange of intelligence and targeting information. This includes coordinating with the CBR officer and the TPC to plan and control the best use of organic and attached radar assets. Target information gathered from the TPC is provided to the SCAR to update the MEF intelligence picture. The force artillery intelligence section may provide personnel as required to the MEF liaison team to facilitate information flow.

Target Acquisition

The force artillery has organic AN/TPQ-46A radars and may have attached artillery target acquisition systems (AN/TPQ-46A or United States Army AN/TPQ-37). Force artillery will position its organic/attached weapons-locating radars and artillery observation teams to best support the target acquisition requirements of the MEF. Depending on the situation, the CBR officer and all TPC assets will either be located with the MEF force artillery liaison team at the MEF or at the

force artillery COC. Force artillery will coordinate the employment of all radars in the MEF zone to include the establishment of radar zones and queuing schedules. Once coordination is completed, the force artillery CBR officer will publish the MEF radar employment plan.

Counterfire

MEF counterfire functions are controlled and coordinated in the MEF FFCC. Primarily artillery, air, and EW units, supported by an integrated intelligence system, conduct the counterfire fight. The preferred method for counterfire is a proactive approach involving sound IPB and a thorough collection plan to locate threat fire support assets prior to firing. Reactive counterfire emphasizes speed during the initial engagement through the employment of dedicated sensor-to-shooter channels and pre-authorized engagement criteria. Full integration of the FDC, the TPC, and the intelligence sections within the intelligence operations center (IOC) is crucial to the timely planning and execution of the counterfire mission. The initial engagement is intended to suppress the hostile fire support system long enough for a more decisive engagement to be developed and executed. A counterfire liaison officer may be established within the MEF FFCC to coordinate the engagement of counterfire targets.

Threat fire support assets located by force artillery will be reported to the SCAR. Targets that meet the criteria for immediate attack as set forth in the reactive attack guidance matrix will be engaged by force artillery, passed to the GCE to attack, passed through the quick fire channel to the ACE TACC or to the MEF FFCC for disposition. See MCWP 3-16.

Force artillery will establish a liaison element within the MEF FFCC to facilitate information flow. That liaison element may include personnel

designated to facilitate counterfire functions. Dedicated communications links (quick-fire channels) between the force artillery FDC and the FFCC current fires and the TACC are essential.

Force artillery may provide a liaison to the MAW to facilitate the employment of the quick-fire channel. It may also receive a liaison team from the TACC. The purpose of these liaison exchanges is to facilitate fire support coordination.

The counterfire execution plan will be developed/validated daily. It consists of a counterfire analysis which defines/describes the counterfire threat in the MEF AO; a counterfire collection plan (description of sensors which cover the expected counterfire target locations); and the counterfire matrix. In general, one of the following counterfire scenarios will occur:

- If a counterfire target is located by division assets and is within their zone, it is the division's responsibility and they attack it. The division can request reinforcing fires, if required or appropriate.
- If a counterfire target is located by force artillery target acquisition assets and is located within a division zone, that target is passed to the division for engagement.
- If either division or force artillery assets locate counterfire targets in an adjacent ground force zone, they are passed to that ground force FSCC through the MEF FFCC.
- If a division asset in the MEF zone locates a counterfire target, either the ACE or the force artillery passes that target to the FFCC for attack.
- If force artillery assets in the MEF zone locate a counterfire target and they are capable of engaging it, the force artillery liaison will coordinate the attack with the MEF FFCC. If the force artillery is not capable of engaging the target, it may be passed to the ACE, via the quick-fire channel.

Meteorological Support

All met operations for force artillery will be conducted in accordance with MCWP 3-16.5, *Field Artillery Meteorology*. In addition to normal duties of providing met support to organic and attached units of force artillery, the force artillery met section will be responsible for integrating or coordinating met support operations with the GCE artillery met sections.

Survey Support

Survey operations for the force artillery are the same as discussed in MCWP 3-16.7. The force artillery survey section will be responsible for providing survey support to all organic and attached units of the force artillery. The force artillery survey officer may be assigned responsibility for survey control within the MEF AOR and will integrate/coordinate survey support with GCE artillery survey operations.

Communications

Force artillery responsibilities encompass the entire MEF's battlespace. Distances involved in this area are well beyond those contemplated for division artillery. The force artillery commander will be required to communicate with his/her organic or assigned battalions, liaison sections, and supported GCE units. This may involve the use of nonstandard equipment such as personal computer-based software and Secret Internet Protocol Router Network. The MEF is responsible for providing communications assets to augment force artillery organic assets to accomplish this task.

Logistics

Force artillery is the largest artillery regiment in the Marine Corps and usually the largest artillery regiment in the MEF force list. Logistics for force artillery may differ from that required by a traditional artillery regiment in two ways:

- First, force artillery may be required to support a front of two or more divisions. Consequently, the distances traveled to effect resupply of force artillery units could be significantly greater than those of their division counterparts.
- Secondly, force artillery is a wartime addition to the MEF. The habitual relationships that exist between combat and CSS units in the MEF do not exist for the force artillery. Planners need to carefully consider logistics requirements using METT-T. For example, force artillery may have attached assets that use different ammunition (United States Army MLRS) or require different types of support equipment not owned by the MEF. This support must enable force artillery to operate in a self-sustaining, self-contained fashion to avoid placing an additional logistical burden on the MEF it supports.

CHAPTER 8

ARTILLERY COMMUNICATIONS

General

Reliable communication is a basic requirement for the maximum employment of artillery. FMFM 6-18.1, *Tactics, Techniques, and Procedures for the Marine Corps Fire Support System*, outlines procedures for configuring nets for data transmission with automated systems.

Forms of Communications

The two original forms of communication—written and voice—have been augmented by automated systems with a third form of communication—data. Data communications increase the speed of communicating on the battlefield, transmitting large amounts of information while reducing signature and enhancing survivability. Data communications require prior integration to succeed in information processing and dissemination.

Means of Communications

There are three primary means of communication: radio, wire, and messenger. Whenever possible, units should plan to use all means of communication to provide redundancy. Proper planning and unit SOPs should provide guidance on when to employ primary, secondary, and tertiary means of communication; i.e., if primary is data communications over a radio net, will a separate voice net be employed until data communication is established or under what contingencies will voice be or not be used?

Radio

Single channel radio is the primary method of communications in artillery operations. Normally, it is used between observers and artillery units. Single channel communications can be secured and used for transmitting voice and data communications.

Radio nets must be specified as voice or data. A net cannot sustain both forms of communication. However, procedures should exist for data nets to use voice transmissions when establishing or re-establishing communications. Data radio nets have a lesser range capability than voice nets. Properly maintained and configured equipment and directional antennae help minimize this limitation.

Figures 8-1 through 8-4 (pages 8-6 through 8-9) show fire support radio nets and net control, guard, and monitor responsibilities. Figures 8-5 and 8-6 (page 8-10) show communication connectivity for regiments and DS battalions.

Wire

Wire is most often used to connect cells within a COC and connect multiple automated terminals within a cell. Where the tactical situation permits, wire provides a redundancy for some radio nets. Often, an FSC may want a direct wire link that does not pass through a switchboard (hotline) to the supporting artillery FDC or the TPC. Wire communications can be secured and used for both voice and data communications.

Messenger

The use of messengers must be planned. They provide a secure, reliable means of communications. If time permits, they may be the most effective means for sending fire support plans and overlays.

Communications System Planning

Artillery nets are established to conduct fire mission processing and fire support coordination as efficiently as possible with the least amount of assets. Radio communications allow artillery nets to be monitored at appropriate levels to ensure effective, timely, and accurate fire support. Considerations for planning include assets available, number of nets required, number of stations per net, digital systems, and information flow. When the communications system incorporates digital communications, the planner must ensure equipment compatibility at the various levels; e.g., between FOs, FDCs, TPCs. Subscribers must configure their devices with the correct parameters as well as ensure messages/transmissions are addressed to all appropriate elements. Another consideration is the security of nets.

Security

Force protection entails communications security. Communications that can be intercepted are a lucrative source of intelligence to the threat. However, speed and accuracy of communications are also critical to friendly operations, particularly in artillery operations. There may be situations when these requirements conflict; i.e., sufficient encryption devices to cover all nets coupled with a requirement for rapid communications. In these instances, security takes precedence on nets where targeting and fire planning information is passed, since the threat may intercept these communications and take appropriate counteraction. On the other hand, speed and accuracy take precedence on nets where immediate requests for fire are passed. Even if these communications are intercepted, there is seldom time for the threat to warn the personnel or units affected.

Communication Nets

Radio circuits employed by artillery units are discussed in the following paragraphs. The net composition depicted in this chapter is a common

composition. The influx of automated systems requires consideration as to the nets that will be digital or voice without increasing asset requirements. Because of threat electronic countermeasure capabilities, communications equipment failures or lack of radios or personnel, it will not always be possible for COCs/FDCs to monitor the circuits shown in figure 8-1, on page 8-6. The S-3 should coordinate with the S-6 for establishing net structure and net priorities. Then, when some circuits are lost or become inoperable, the most important nets will be retained and communications will be restored in the order of the established priority.

Artillery Regiment Communication Nets

Division Command Net

This HF net provides a means for the division commander to command and coordinate administrative and logistical activities of subordinate units. Artillery stations include the following:

- Artillery regiment.
- Artillery battalion with a GS or GS-R tactical mission.
- O/O artillery battalion with alternate regiment CP mission.

Division Tactical Net

This VHF net provides a means for the division commander to C2 major combat units. Examples include changes to tactical mission assignments and displacement reports. It may also be used as an alternate to the division command net. Artillery stations are the same as above for the division command net.

Division Artillery Air Spot Net

This VHF net provides a means for aircrews to adjust artillery fire. When the net is in use, the artillery LNO monitors for targets in his/her unit's zone just as he/she does with COF nets. The FO may use this net to coordinate with the

aircrew for attack of targets in his/her company's zone. Artillery stations include the following:

- Artillery regiment, net control. For specific missions, control may be passed to the FDC conducting the mission (battalion or battery).
- Artillery battalion, as required.
- Firing battery, as required.

Division Fire Support Coordination Net 1

This VHF net provides a means for the division FSC to coordinate voice fire support. Artillery stations include the following:

- Artillery regiment.
- Artillery battalion with a GS or GS-R tactical mission.
- O/O artillery battalion with alternate regiment CP mission.

Division Fire Support Coordination Net 2

This VHF net provides a means for the division FSC to coordinate digital fire support. Artillery stations are the same as those for net 1.

Division Communication Coordination Net

This VHF net provides a means for the G-6 to coordinate, install, and restore communication circuits with subordinate units. Artillery stations are the same as those for net 1.

Division Intelligence Net

This VHF net provides a means for the rapid collection and dissemination of intelligence information. Artillery stations are the same as those for net 1.

Artillery Regiment Command Net

This HF net provides a means for the artillery regiment commander to command and coordinate administrative and logistical activities of

subordinate units. It may be used as an alternate for fire direction and tactical orders. The division FSC may monitor, as required, principally as an alternate net for communicating with the artillery regiment should other nets become inoperative. Artillery stations include the following:

- Artillery regiment, net control.
- Artillery battalions.
- Attached units.

Artillery Regiment Tactical Net

This VHF net provides a means for the artillery regiment commander to C2 subordinate units. Examples of types of traffic include changes in tactical mission assignments and reports of displacements. It may also be used as an alternate fire direction and FSC net. Artillery stations are the same as those for the command net.

Artillery Regiment Fire Direction Net

This VHF net provides a means for the artillery regiment to exercise tactical fire direction; i.e., transmitting orders, fire missions, fire plans, tactical information, and net data to battalions. Regiment fire direction is also the net used to collect, exchange, and pass combat and target information. This net may be voice or digital. It may be used by subordinate units to request R fires. The artillery officer at the division FSC may monitor to keep abreast of artillery fire planning and to pass FSC traffic if no other net is available. Artillery stations include the following:

- Artillery regiment, net control.
- TPC via relay through the regiment FDC.
- Artillery battalions.
- O/O artillery battalion with alternate regiment COC mission.

Artillery Regiment Survey/Met Net

This VHF net provides a means to provide survey information from survey teams and a means to

exchange net information and ballistic net information between artillery units. Artillery stations include the following:

- Artillery regiment, net control.
- TPC via relay through the regiment FDC.
- Artillery battalions.

Artillery Regiment Radar Telling Net

This VHF net provides a means for the exchange of radar intelligence information and requests for surveillance of threat counterfire weapons. It may also be used for registration and adjustment of artillery fire. Artillery stations include the following

- Artillery regiment, net control.
- TPC via relay through the regiment FDC.
- Artillery battalions, as required.
- Artillery batteries, as required.

Artillery Regiment Communication Coordination Net

This VHF net provides a means for the S-6 to coordinate, install, and restore communication circuits with subordinate units. Artillery stations include the following:

- Artillery regiment, net control.
- Artillery battalions with DS tactical missions.

Artillery Battalion Communication Nets

Artillery Battalion Command Net

This VHF net provides a means for the artillery battalion commander to C2 subordinate units. It is principally used for administrative, logistic, and tactical traffic not related to fire direction. The supported regiment FSCC may monitor, as required, principally as an alternate net for communicating with the DS battalion should other nets become inoperative. Artillery stations include the following:

- Artillery battalion, net control.
- Firing batteries of the artillery battalion.
- Artillery battalions with an R mission.

Artillery Battalion Fire Direction Net

This VHF net may be voice or digital. When operating voice, this net provides a means for the artillery battalion to exercise tactical fire direction of subordinate units. If tactical fire direction is decentralized, this net may be used by batteries to request reinforcing fires. The artillery LNO at the regiment FSCC (battalion FSCC as required) may monitor to keep abreast of artillery fire planning and significant artillery missions. In a digital environment, tactical fire direction is incorporated into a COF, and battalion fire direction is used for coordinating reinforcing fires. Artillery stations include the following:

- Artillery battalion, net control.
- Firing batteries of the artillery battalion.
- Artillery battalions with an R mission.

Artillery Conduct of Fire Net

This VHF net provides a means for observers to request and adjust artillery fire. The artillery LNO at battalion FSCCs monitors/receives traffic on the net for FSC purposes. FOs and LNOs may use the net to exchange targets and fire planning information. If conducting battalion-directed operations, the battalion establishes as many as three COF nets and acts as net control on each. The artillery battalion may identify a COF net for each maneuver battalion to facilitate continuity of fire support during battery displacements. The maneuver battalion (LNOs, FOs) remains on the assigned COF net, and the artillery battalion FDC receives all calls for fire. It then designates which firing battery will provide fire support to the maneuver battalion. This allows the artillery battalion to quickly mass on larger targets, as well as manage the assets of the battalion as a whole. If conducting autonomous operations, each battery FDC maintains a COF net and acts as net control (each net is monitored by the battalion FDC when present). Autonomous operations are also conducted by batteries attached to a BLT. When observers are employing digital devices, one or more COF

nets must be dedicated to digital communications. Artillery stations include the following:

- DS artillery battalion headquarters.
- Firing battery.
- Artillery LNO at battalion FSCC.
- FOs.
- Artillery LNO at regiment FSCC, as required.
- Artillery units with an R mission.

Artillery Battery Communication Nets

Artillery Battery Command Net

This VHF net provides a means for the artillery battery commander to command and coordinate administrative and logistical matters. Artillery stations include the following:

- Artillery battery headquarters.
- Subordinate elements, as required.
- Artillery battery convoy, as required.

Artillery Conduct of Fire Net

See artillery battalion communication nets.

DS Artillery Battalion Communication Nets

Artillery battalions with a DS tactical mission are required to monitor various maneuver unit communication nets. The following designated nets must be monitored:

- Infantry regiment FSC net (VHF) (There may be a separate digital radio net.).
- Infantry regiment command net (HF).
- Infantry regiment tactical net (VHF/HF).
- Infantry regiment intelligence net (VHF/HF).
- Infantry regiment communications coordination net (VHF/HF).

Alternate Uses of Nets

The nets described previously will normally accommodate the communications requirements for effective artillery operations. When used for their stated purpose, circuits do not overload and remain free for necessary communications. However, should some nets become unavailable through heavy traffic, threat interference or equipment failure, personnel should not hesitate to use any available net to pass urgent traffic. The number of nets, plus the availability of wire, provides flexible options for artillery personnel to provide continuous communications.

ARTILLERY REGIMENT NETS	01	02	03	04	05	06	07	08	09	10	11	12	13	14	
LEGEND: A = As Required C = Net Control M = Monitor W = When Directed X = Guard	D I V C M D	D I V T A C	D I V A R T Y S P O T	D I V F S C 1	D I V F S C 2 D I G	D I V I N T E L	R E G T C M D	R E G T T A C	R E G T F D 1 D I G	R E G T F D 2 V O I C E	S U R V E Y / M E T	R A D A R T E L L I N G D I G	D I V C O M M C O O R D	R E G T C O M M C O O R D	
	EMISSION DESIGNATORS	HF	VHF	VHF	VHF	VHF	VHF	HF	VHF	VHF	VHF	VHF	VHF	VHF	VHF
	RESTORATION PRIORITIES	06	04	14	01	02	08	07	05	03	11	09	10	12	13
	Division FSCC	C	C	A	C	C	C						X	C	
	Artillery Regiment FDC	X	X	A	X	X	X	C	C	C	C	X	X	X	C
	Artillery Regiment TPC											C	C		
	Artillery Regiment Commander	X						A	X						
	Artillery Battalion Commanders							X							
	Artillery Battalion DS			W				X	X	X	X		W		X
	Artillery Battalion GS			W				X	X	X	X		W		
Artillery Battalion GS-R/R			W				X	X	X	X		W		X	
Radar												X			
MDS											X				
MLRS (if applicable)								W							
Remotely Piloted Vehicle (if applicable)								W							
Infantry Battalion FSCC									W	W					

Figure 8-1. Example Artillery Regiment Guard Chart.

DIRECT SUPPORT	01	02	03	04	05	06	07	08	09	10	11	12	13	14	15	16	17
LEGEND: A = As Required C = Net Control M = Monitor W = When Directed X = Guard	B N C M D	B N C O F A	B N C O F B	B N C O F 1	B N C O F 2	R E G T F S C 1	R E G T F S C 2	I N F R E G T C M D	I N F R E G T T A C	R A D A R T E L L I N G	B N F D 1	R E G T F D 1	R E G T F D 2	A R T Y R E G T T A C	A R T Y R E G T C M D	D I V A R T Y S P O T	B N C O M M C O O R D
EMISSION DESIGNATORS	V H F	V H F D I G	V H F D I G	V H F	V H F	H F	V H F D I G	V H F	H F	V H F	V H F	V H F	V H F	V H F	H F	V H F	
RESTORATION PRIORITIES	06	09	10	01	02	03	11	15	05	12	04	08	14	07	13	16	17
Artillery Battalion	C	C	C	C	C	X	X		X	C	C	X	X	X	X	W	C
Artillery Regiment												C	C	C	C	C	
Infantry Regiment						C	C		C								
Artillery Battalion Commander	X													A	X		
Artillery Battery Commander	X																
Battery 1		X		M						A	X						X
Battery 2		X		M						A	X						X
Battery 3			X		M					A	X						X
Battery 4 (if applicable)			X		M					A	X						X
Infantry Regiment FSCC		X		X								M					
FO 1		X		X													
FO 2		X		X													
FO 3		X		X													
FO 4		X		X													
FO 5		X		X													
FO 6		X		X													
FO 7			X		X												
FO 8			X		X												
FO 9			X		X												
FO 10 (if applicable)			X		X												
FO 11 (if applicable)			X		X												
FO 12 (if applicable)			X		X												
Radar (if attached)										X	X						
Met											A		X				
Survey	X																
LNO Battery 1		X		X		X	X					X					
LNO Battery 2		X		X		X	X					X					
LNO Battery 3			X		X	X	X					X					
LNO Battery 4 (if applicable)			X		X	X	X					X					

Figure 8-2. Example Direct Support Artillery Battalion Guard Chart.

GENERAL SUPPORT	01	02	03	04	05	06	07	08
LEGEND: A = As Required C = Net Control M = Monitor W = When Directed X = Guard	B N C M D	B N F D	R E G T F D 1 D I G	R E G T F D 2 V O I C E	R A D A R T E L L I N G D I G	R E G T C M D	R E G T T A C	B N C O M M C O O R D
	EMISSION DESIGNATORS	V H F	V H F	V H F	V H F	V H F	V H F	V H F
RESTORATION PRIORITIES	04	02	01	07	06	05	03	08
Artillery Battalion	C	C	X	X	W	X	X	C
Artillery Regiment			C	C	C	C	C	
Artillery Battalion Commander	X						A	
Battery Commanders	X							
Battery 1		X			W			X
Battery 2		X			W			X
Battery 3		X			W			X
Battery 4 (if applicable)		X			W			X
Radar		W			X			
MDS		X						
Survey	X							

Figure 8-3. Example General Support Artillery Battalion Guard Chart.

GENERAL SUPPORT-REINFORCING	01	02	03	04	05	06	07	08	09
LEGEND: A = As Required C = Net Control M = Monitor W = When Directed X = Guard	B N C M D	B N F D	R E G T F D 1 D I G	R E G T F D 2 V O I C E	R A D A R T E L L I N G D I G	R E I N B N F D	R E G T C M D	R E G T T A C	B N C O M M C O O R D
	EMISSION DESIGNATORS	V H F	V H F	V H F	V H F	V H F	V H F	V H F	V H F
RESTORATION PRIORITIES	05	03	08	01	06	02	07	04	09
Artillery Battalion	C	C	X	X	W	X	X	X	C
Artillery Regiment			C	C	C		C	C	
Rein Artillery Battalion			X	X		C	X	X	
Artillery Battalion Commander	X							A	
Battery Commanders	X								
Battery 1		X			W				X
Battery 2		X			W				X
Battery 3		X			W				X
Battery 4 (if applicable)		X			W				X
Radar		W			X				
MDS		X							
Survey	X								

Figure 8-4. Example General Support-Reinforcing Artillery Battalion Guard Chart.

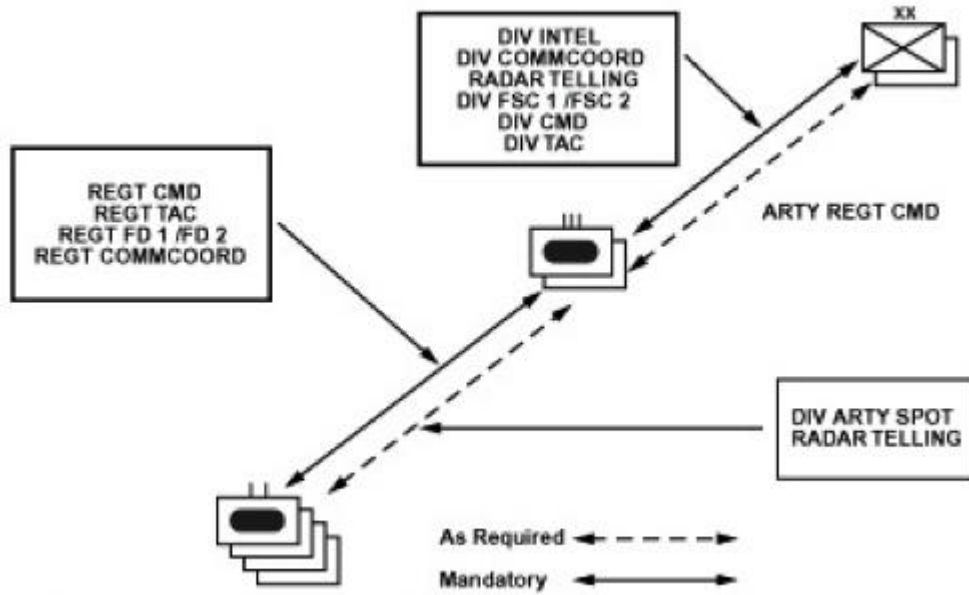

NOTE: There may be a quick fire channel established from any of the artillery units to a fire support asset.

Figure 8-5. Example Artillery Regiment Communication Structure.

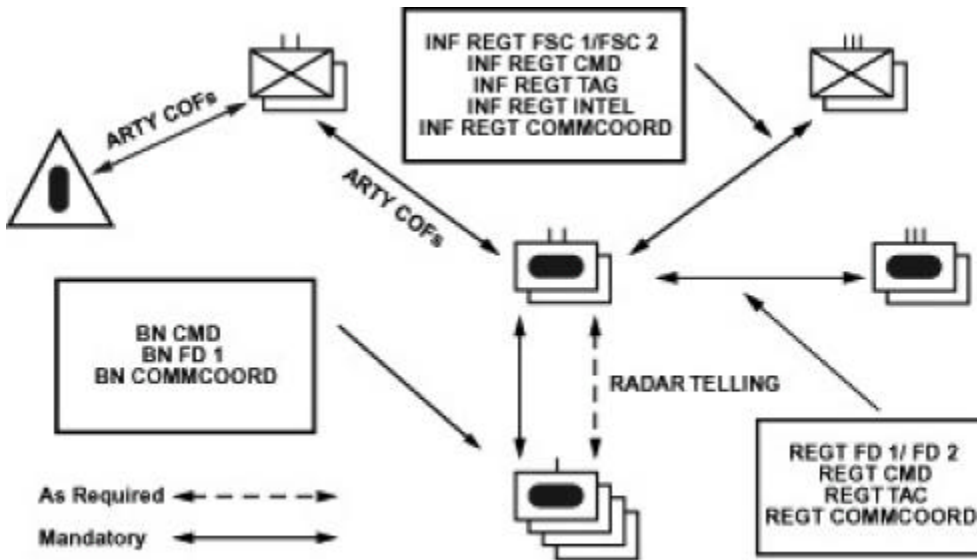

NOTE: There may be a quick fire channel established from any of the observers to a fire support asset.

Figure 8-6. Example Direct Support Artillery Battalion Communications Structure.

CHAPTER 9

ARTILLERY TACTICAL LOGISTICS

SECTION I. FUNDAMENTALS

Background

Artillery units must provide responsive, effective, and sustainable fires in a variety of operating environments. Logistics is the lifeline that arms, fuels, supplies, and maintains the artillery enabling it to fulfill its mission. In the GCE, artillery will be a demanding consumer of resources, particularly ammunition and fuel.

Logistics Principles

Responsiveness, simplicity, flexibility, economy, attainability, sustainability, and survivability guide the planning, organization, and conduct of logistics. A principle's influence varies with each operation or phase of operation. The artillery commander must ensure these principles are applied to ensure the availability of responsive, effective, and sustainable artillery support.

Artillery S-4 Duties

Commanders are responsible for their unit's logistics. At the regiment and battalion levels, the S-4 assists the commander in planning, supervising, and coordinating daily logistic functions. The S-4 coordinates with the S-3 to ensure support of operations and exercises staff cognizance over special staff officers who manage specific commodity areas. In the firing batteries, the XO normally fulfills the responsibilities similar to the S-4.

During operations, critical tasks performed by the S-4 include supervising the implementation of the

ammunition plan, maintaining the status of ammunition stocks, recording and disseminating critical information, coordinating transportation requirements and availability, and supervising management maintenance resources.

Supervising the Ammunition Plan

The S-3 develops the ammunition plan, to include allocations for specific training events and subordinate units, and supervises its implementation. This includes remaining abreast of the assault support request (ASR), road net, ammunition issuance, proposed operations, transportation availability, supply point locations, and anticipated consumption. The S-4 recommends to the next higher echelon (S-4 or G-4 as applicable) movement of supply points farther forward when timely resupply to the unit becomes difficult.

Maintaining Ammunition

The S-4 maintains an accurate inventory of available ammunition. The S-4 coordinates with the S-3 to maintain the organization's ammunition status.

Recording and Disseminating Information

The S-4 collects and disseminates pertinent logistic information. The information exchange should involve subordinate, higher, adjacent, and supported units' S-4 and CSSE as required.

Coordinating Transportation Requirements

The S-4 should be aware of the status of traffic data and road networks through the use of engineer reports, etc. The S-4 coordinates traffic schedules, routes, and road priorities with higher, subordinate,

adjacent, and supported units and appropriate movement control centers. The force commander's road priority determines allocation of road space to subordinate artillery units. The S-4 provides traffic data and transportation availability to the S-3. The S-3 can publish movement graphics that show the location of units during displacement or when MSR's are congested. These graphs aid in establishing priorities based on the rate of march, time length of the column, distance to be covered, and tactical advantages expected (in cases of displacement). See figure 9-1.

Supervising Management Maintenance Resources

The S-4 assists the commander in the allocation and prioritization of maintenance within the unit.

Additionally, the S-4 coordinates the use of outside maintenance resources.

Concept of Support and Logistic Capabilities

Tactical logistics includes the organic unit capabilities and the CSS activities necessary to support military operations. It involves the coordination of functions required to sustain and move units, personnel, equipment, and supplies.

As a part of the GCE, Marine artillery also has organic logistic capability. Within the MAGTF, the CSSE provides most of the non-organic logistic support.

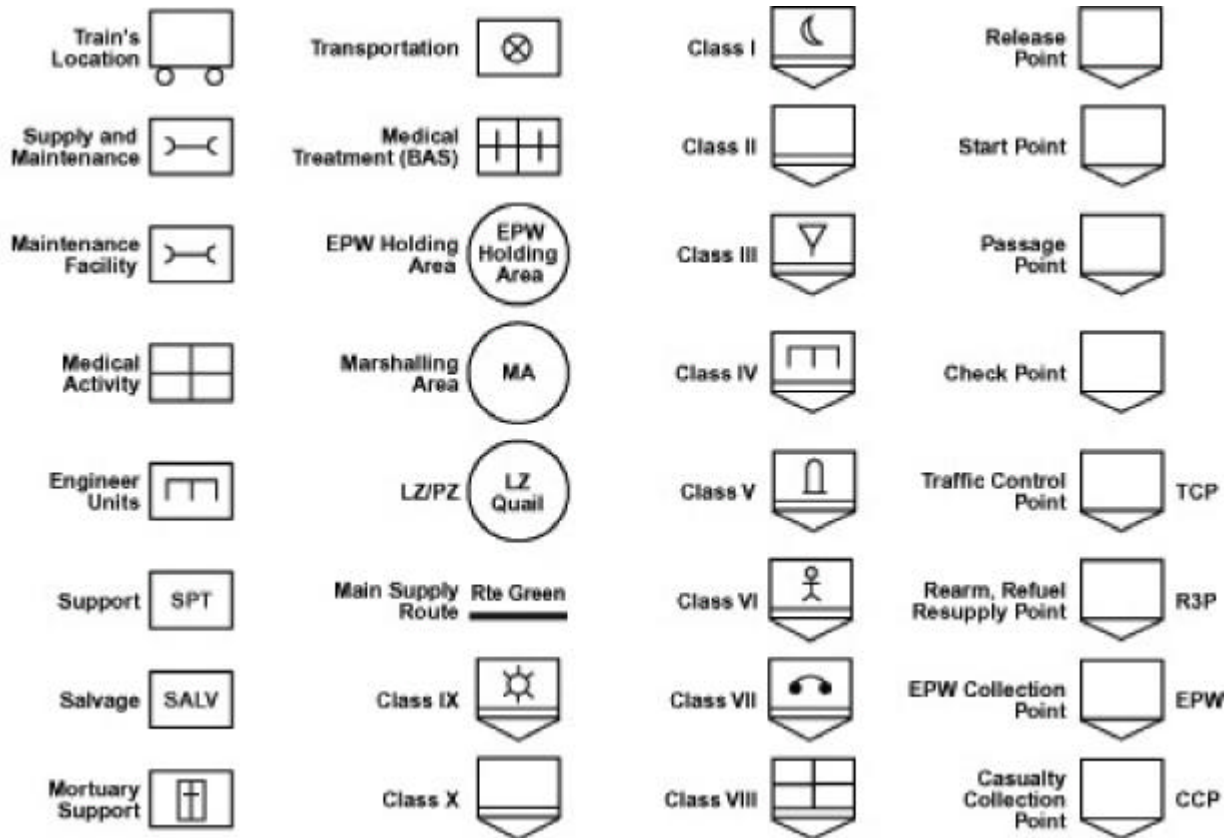

Figure 9-1. CSS Map Symbols.

Organic

Tactical Logistic Functions

Artillery units exercise each of the logistic functions (supply, maintenance, transportation, general engineering, health services, and services) to some degree. They are also responsible for command functions, such as messing. Each battalion possesses limited, organic logistic capabilities and is capable of independent operations. Firing batteries normally rely on their parent battalions for higher-level logistic support when conducting battalion operations. However, firing batteries also have a limited number of organic mechanics, ammunition technicians, and corpsmen, which may require augmentation of other personnel as needs arise; e.g., additional Marines and sailors of the type listed or other types depending on METT-T. When detached from their parent battalion, batteries must rely on their organic capability and the support provided by the gaining unit or CSSE inherent in the MAGTF.

Messing

Ensuring adequate messing support to using units is a command responsibility. The artillery regiment and battalions have organic messing capabilities. The food services officer, under the cognizance of the S-4, supervises the food service's section including the requisition, storage, and preparation of meals. The artillery regiment may choose to consolidate its food service specialists with those of the battalions to form a consolidated mess hall in garrison and/or a consolidated field mess when the entire regiment is deployed.

External Combat Service Support Organizations

Artillery units obtain external CSS from various MAGTF CSS organizations. The artillery S-4 must be familiar with each CSS organization to effectively use available resources. CSS units can be permanently organized or task-organized. Based on their organizational structure, they may be single-function or multi-function units. See MCWP 4-11, *Tactical Logistics*, for further details on CSS organizations.

SECTION II. PLANNING

General

Each commander from the firing battery to the regiment must know and apply logistic concepts and principles in planning. Just as artillery planning is conducted continuously and concurrently with maneuver planning at all levels, logistic staff officers must focus on supporting a "single battle" concept. MCWP 5-1, *The Marine Corps Planning Process*, provides the sequence of planning. MCWP 4-11 contains specific planning guidance.

MAGTF Artillery Officer

At the beginning of an operations planning phase, the senior MAGTF artillery officer estimates overall artillery requirements and determines the artillery's

ability to provide effective, continuous support for each proposed COA. Early, accurate identification of logistic requirements is crucial to effective CSS. The artillery unit prepares estimates of supportability and artillery requirements. An estimate of artillery requirements addresses the amount and type of artillery, ammunition, shipping, landing craft, aircraft, and special equipment. Special training requirements may also be identified. Combat planning data (MCO 8010.1E, *Class V[W] Planning Factors for Fleet Marine Force Combat Operations*), METT-T factors, and experience are used in estimating requirements. Requirements submitted by artillery commanders are consolidated and analyzed, overall requirements are refined, and final artillery requirements are presented to the force/MAGTF commander. Continual modifications are made as planning progresses.

Artillery Commander and Staff

The artillery commander prepares estimates, issues guidance, establishes priorities, and allocates resources as required. Staff officers determine requirements and concerns from their functional areas. Requirements are consolidated at the senior artillery echelon and forwarded through the chain of command. At a minimum, artillery logistic plans must address the following:

- External support requirements.
- Basic load and corresponding unit load plans.
- Embarkation and debarkation requirements.
- The ammunition plan.
- Methods of resupply.
- Organization of logistic resources; e.g., trains or MCTs.
- Logistic communication links.
- The casualty treatment and evacuation plan.
- Anticipated problem areas.
- Security for trains and rear area facilities.

METT-T

Mission

Requirements, priorities, allocations, and mobility are affected by the mission. Certain mission types will increase demands for specific items. A movement to contact may place more emphasis on petroleum, oils, and lubricants (POL) and mobility, while a deliberate attack may increase ammunition consumption rates.

Enemy

An analysis of threat capabilities and composition serves to identify logistic requirements and friendly logistic vulnerabilities.

Terrain and Weather

Terrain (including the impact of weather) has multiple effects on logistics. Table 9-1 identifies selected environmental impacts on CSS functions.

Troops and Support Available-Time Available

The number of firing units and personnel/equipment available to sustain them must be considered in developing a logistic plan.

Rates of movement and frequency of displacements impact the ability to provide forward CSS. Timetables must be scrutinized to ensure the logistic plan provides the necessary support.

Evaluating Logistic Data

Supply, transportation, maintenance, and health services affect the unit's basic load and impact planning data in developing estimates and the logistics annex to the operation order. The information in the rest of this section is a guide. It should be tailored to fit the needs of the specific tactical situation.

By analyzing each logistic function, the artillery staff develops its requirements and concept of support to include an evaluation of logistic data that centers on the unit's basic load. The basic load is the on-hand supplies required by a unit, the quantities of supplies that must be carried by the unit and transported by the unit organic lift. Operational requirements, cargo capacity of unit vehicles, and methods and means of resupply affect the composition of the basic load and logistic functions. The artillery commander may forward a recommendation through appropriate command channels for consideration by higher headquarters for establishing the basic load.

Table 9-1. Environmental Impacts on CSS

Environmental Factors	Supply	Maintenance	Transportation	General Engineering	Health Services
Urbanized Terrain	Land lines of communications can be impeded	Maintenance areas available	Reduces movement	Existing utilities available	Existing facilities available
	Existing supplies available	Reduces maintenance due to fewer displacements	Increases use of MHE due to dispersion of battery positions	Requires clearance of rubble	
	Increases expenditure of Class V (delay, VT fuzes)			Requires fortification of positions	
Arctic/Cold Weather	Land lines of communications are few and extended	Increases maintenance time	Restricts ground mobility	Increases use of hardened positions	Affects personnel
	Reduces ammunition-carrying capacity	Requires frequent, regular warm-up of engines, radios, and batteries	Increases transportation needs due to battlefield size	Materials handling difficult	Increases food intake
	Increases use of batteries	Maintenance areas critical and limited	Requires special cross country ability (snowplow or snowshoes)	Construction of barriers difficult in frozen ground	Sanitation difficult
	Reduces effects of ammunition in snow	Requires daily tire pressure checks to prevent flat tires and flat spots	Navigation difficult		
	Increases effects of ammunition on ice	Requires periodic relocation of vehicles to avoid flat spots	Fuel handling dangerous		
	Sustainment of Class I difficult		May require use of chains for wheeled vehicles		
	Requires supplementary rations				
	Limited potable water				
	Requires transport of ice blocks				
	Prepositioning and storage of materiel is key to sustainment				
Desert	Extended land lines of communications	Affects equipment		Wheeled vehicle movement difficult with heavy loads (Class V, howitzers)	Increases use of hardened positions
	Increases use of Class V (smoke, suppression, countermechanized fires)	Increases PM	Increased mechanized/motorized operation requires frequent displacement	Requires obstacles clearing	Evacuation difficult
	Increases use of Class III (POL, tires, coolant, cleaning materials)	Increases on-site maintenance and repair to reduce evacuation	Restricts movement to mission-essential loads only		Sanitation difficult
	Increases use of Class IX (electrical, accessories for coolant system, wheel and sprocket nuts, wedge bolts)	Navigation difficult			
	Increases water and battery requirements	Poor roads			

Table 9-1. Environmental Impacts on CSS - Continued.

Environmental Factors	Supply	Maintenance	Transportation	General Engineering	Health Services
Desert (Continued)	Increase Class V consumption	Increases on-site repair to reduce evacuation	Potential for bottlenecks		Evacuation difficult
	Requires unit distribution		Increases use of helicopter support		
	Restricts communication				
Chemical/Nuclear	Hampers resupply due to unit dispersion and avoidance of contaminated areas	Decontamination of equipment difficult	Requires vehicles to transport NBC/decontamination equipment	Increases use of fortifications	Hampers prevention and treatment of casualties
	Restricts supply to mission-essential items for short notice displacements				Affects personnel
	Increases water requirement for decontamination				
	Reduces ammunition-carrying capacity				
	Requires protective clothing, decontamination equipment, and special munitions				
Jungle	Lack of all-weather roads hampers re-supply	Increases requirement for PM	Trafficability difficult	Increases need to establish and harden positions	Affects personnel
	Increase Class V usage (reduces munitions effects)	Maintenance difficult	Increases reliance on helicopter support	Requires obstacle clearing support	Increases disease
	Increase deterioration of supplies	Requires on-site maintenance	Increases towing requirements		Evacuation difficult
	Restricts loads to mission-essential items only	Serviceability of winches essential			Requires preventative medicine and sanitation
	Requires frequent air resupply and increases vulnerability of positions				
	POL replenishment difficult				

The established basic load is expressed in terms of day of supply (DOS) and day of ammunition (DOA). At the unit level, these terms are expressed in specific quantities. Unit vehicle load plans are then built around the established basic load. Basic loads may be transported as palletized or nonpalletized loads.

Supply

Pre-calculated blocks of supplies can be allocated from several sources. War Reserve Materiel Stocks Field (a starter stock) includes landing force opera-

tional reserve material and prepositioned material in maritime prepositioning ships. War Reserve Materiel Stocks Inventory Control Point (a swing stock) includes in-stores held at the Marine Corps logistic bases and any war reserve stocks held by other Services or integrated materiel manager. Organic unit operating stocks is also a source.

These resources, as allocated by the MAGTF commander, constitute the supplies available to operational units. Supply is divided into 10 classes, as shown in table 9-2, for planning, management, and administrative purposes.

Table 9-2. Classes of Supply.

Class	Description
I	Subsistence: MRE, A and B rations, and water
II	Clothing, individual equipment, tentage, organizational tool sets and kits, hand tools, and administrative and housekeeping supplies and equipment
II	POL: petroleum fuels, lubricants, hydraulic and insulating oils, liquid and compressed gases, bulk chemical products, coolants, de-icing and anti-freeze compounds, and preservatives
IV	Construction material: installed equipment and fortification, barrier, and bridging material
V(W)	Ground ammunition: munitions containing explosives; chemical, nuclear, or radiological weapons; or any item that is propelled, placed, or dropped to inflict damage
VI	Personal demand items: nonmilitary sales items
VII	Major end items: end products ready for intended use
VIII	Medical items
IX	Repair parts: all repair parts, less Class VII, required for maintenance of equipment
X	Nonmilitary programs: military support programs not included in Classes I through IX: e.g., agricultural, economic development

Class I

Sufficient rations per individual must be carried in the artillery’s basic load to provide subsistence through a ration cycle. One ration cycle, normally 24 hours, is designated as a DOS. The type of rations depends on the tactical situation, commander’s guidance, and availability of messing facilities. Table 9-3 provides planning data for transporting rations.

Water requirements depend on the tactical situation, personnel consumption, vehicle maintenance,

decontamination, bath/shower/laundry availability and frequency, and method of transport/resupply. Table 9-4 on page 9-8 provides data for planning water requirements for personnel.

Class II

The basic load of Class II items depends on the tactical situation, commander’s guidance, environment, and vehicle cargo space. Specific items, volume, weight, and replenishment factors are found in current tables of authorized material.

Table 9-3. Planning Data for Rations.

Ration Type	Content (portion/packaging)	Weight (lbs) per Unit	Volume (ft ³) per Unit
MRE	12 meals/case	20.60	0.88
Ration cold weather	6 rations/case	21.30	0.90
B	3 servings/ration	3.83	0.12
T (Tray Pack)	18 meals/module:		
	Breakfast	33.00	1.66
	Dinner	45.00	1.66

Table 9-4. Water Planning Data for Personnel.

Use	Gallons per individual per day		
	Hot Climate	Temperate Climate	Cold Climate
Drinking ¹	3.0	1.5	2.0
Heat Treatment	0.2	0.0	0.0
Hygiene ²	1.7	1.7	1.7
Food Prep	0.0 - 4.5	0.0 - 4.5	0.0 - 4.5
Waste (10%)	0.8 - 1.3	0.7 - 1.1	0.7 - 1.2
Decontamination ³	7.0	7.0	7.0

1. Increase to 3.5 (hot) and 3.0 (temperate) for MOPP levels 3 and 4.
 2. Personal hygiene (shaving, brushing teeth, washing hands, sponge bath).
 3. Requirements depend on frequency, intensity, and location of attacks.

Class III

Class III consists of fuels and lubricants for vehicles and equipment. Class III items are carried in tankers, fuel pods, and mobile-loaded canned or drummed fuel containers. The S-4 must apply experience and the nature of the operation in calculating fuel

requirements. Table 9-5 contains notional planning data for transporting drummed or canned fuels.

Table 9-6 provides notional planning data for daily fuel usage rates. To determine an estimate, select the statistical region approximating that of the area of operations.

Table 9-5. Transportation Planning Data for Drummed Fuel.

Size	Diesel		Gasoline		Kerosene	
	ft ³	lbs	ft ³	lbs	ft ³	lbs
55-gallon drum	9.0	432	9.0	384	9.0	421
5-gallon can	0.8	46	0.8	41	0.8	45

Table 9-6. Estimates of Daily Fuel Usage Rates.

Equipment Type	Alaska*	Panama Canal*	CONUS*	Europe*	Korea*
Wheeled Vehicle	7	4	8	10	5
Generators	20	20	20	12	20
MHE	10	20	20	12	20
Stationary Equipment	10	10	10	12	10

* Hours of Usage

Table 9-7 provides notional planning data for consumption rates and capacities for various items of equipment in the artillery inventory. Fuel requirement estimates are determined by the following formula:

$$\frac{(\# \text{ of vehicles/equipment}) \times (\text{daily fuel usage rate})}{(\text{consumption rate})} = \text{fuel requirement}$$

For example, an organization with a truck density of 20 5-ton vehicles operating in a Korean-type environment would have the following fuel requirement:

$$(20 \text{ vehicles}) \times (5 \text{ hrs/day}) \times (5.3 \text{ gal/hr}) = 530 \text{ gal/day}$$

Water usage rates are contained in table 9-4. Other figures were extracted from tables 9-6 and 9-7.

Class IV

Class IV includes materials for dunnage and preparing gun positions and other battery areas. Required quantities depend on use and size of the position area. Table 9-8 provides transportation planning data for Class IV material.

Class IV planning determines the usage requirement of sandbags and lumber. Approximately 500 sandbags are required to completely harden a 5-ton truck. The number of sandbags required to prepare a gun position depends on the size and degree of position preparation. Lumber requirements are determined by converting the estimated lineal feet of lumber into board feet using the following formula:

$$\frac{\text{thickness (inches)} \times \text{width (inches)} \times \text{length (inches)}}{12} = \text{board feet}$$

Table 9-7. Consumption Rates and Capacities for Vehicles/Equipment.

Vehicle/Equipment	Fuel			Water*
	Rate (gal/hour)	Tank (gal)	Type	Radiator (gal)
M923	11.5	70	Diesel	12
M998	1.7	25	Diesel	7
M936	13.0	139	Diesel	12
Mk923 MTRV	Unknown	78	Diesel	
Mk48 LVS	Unknown	150	Diesel	27
MC4000	4.0	35	Diesel	6
3 kW GEN (MEP-16)	0.6	90	Diesel	11
M12 DECON	3.0		Gasoline	500

*Water usage rates are calculated using factors of 1.0 (hot and cold climates) and 0.5 (temperate climate).

Table 9-8. Class IV Transportation Planning Data.

Item	NSN	ft ³	Weight (lbs)
Bag, sand (bale)*	8105-00-285-4744	2.1	10
Barbed wire, 350 ft spool	5660-00-512-3197	1.0	28
Post, fence, metal, 2 foot	5660-00-270-1588	3.0	24
Post, fence, metal, 5 foot	5660-00-270-1587	11.0	99
Barbed wire, concertina	5660-00-921-5516	4.4	62

* 200 bags per bale.

Class V

The ammunition plan is developed as a result of determining Class V requirements. It requires close and continuous coordination between unit commanders and operations and logistics officers at all levels. The commander provides guidance and establishes priorities for the ammunition plan. Operations and logistics officers work together in the planning and execution of the ammunition plan.

Based on the commander's guidance, operations officers identify the type, quantity, location/unit, and required time/date of ammunition resupply. Operations officers must forecast required supplies to allow sufficient time for logistics officers to respond. Operations officers establish task organization in support of the logistic effort; e.g., the composition of trains. Logistics officers determine how to fulfill identified requirements and arrange for their distribution. Specific instructions must be established (through SOP, operation order or letter of instruction) for requisition, procedure for issuance, and methods of distribution. Ammunition distribution is normally the unit's most cumbersome logistic effort. Developing an ammunition plan must consider consumption requirements, replenishment requirements, method of resupply, and ammunition management measures.

Consumption Requirements

Consumption requirements of conventional and special ammunition must be determined. The commander tailors the combat planning rates contained in MCO 8010.1E based on his/her experience and specific METT-T operational needs. Planning data, based on MCO 8010.1E, has been calculated for each type of unit/weapon and is provided in appendix E.

Basic Allowance

Basic allowance (BA) refers to the initial distribution of a specified quantity of required ammunition for units entering combat. BA size and composition must meet anticipated unit combat needs until resupply can be accomplished. Combat planning rates may be modified to meet special requirements.

Basic Load

The quantity and type of ammunition carried by the artillery units as the basic load must maximize artillery effectiveness and be tailored to support operational requirements. To position the greatest quantity of ammunition forward, the commander may develop a load of the types of ammunition that will maximize effectiveness. This may result in a basic load mostly of high usage ammunition. The operation or phase of operation will impact ammunition usage rates.

Ammunition-carrying capacities of artillery vehicles are shown in table 9-9 on page 9-12. The basic load of ammunition must be identified in the unit operation order. This provides data useful to the CSSE and liaison officers at the supported unit's FSCE. The basic load is expressed as follows:

$\text{Basic Load} = \text{BA} + \# \text{ DOA (sustaining rate)}$
--

Replenishment Requirements

Ammunition supportability depends on the availability of ammunition in theater, transportation, and time. The artillery commander must anticipate replenishment requirements. Artillery units maintain basic loads from floating dumps or landing force supplies that are loaded for selective discharge. These sources sustain the artillery unit until the supply system is functioning ashore.

Table 9-9. Ammunition-Carrying Capacities.

Vehicle	Caliber	Projectiles	Propellants
M813/923 Prime Mover ¹	155mm	48	48
M813/923 Ammunition Truck ²	155mm	96	336 (GB) 180 (WB) 120 (RB & M119)
M105A2 Ammunition Trailer	155mm	24	112 (GB) 60 (WB) 40 (RB & M119)

1. Combat loaded. May be reduced by safety restrictions (net explosive weight) and vehicle load plan.
2. M813/923 will be replaced by Mk923 MTVR. Mk923 has same bed dimensions.

NOTES:
Based on pure loads and single-type items (e.g., GB propellant) on skid.
Based on cross-country capacities. Data may be reduced by road conditions and vehicle hardening requirements.
Based on high explosive projectiles.
Packing dimensions for ammunition contained in appendix E.

Planning Ammunition Resupply

- Rate and quantity of consumption.
- Road network and distance from battery positions to the source of supply.
- Tactical situation.
- Available vehicles, aircraft, personnel and material handling equipment (MHE).
- Availability of external or organic resources.

Ammunition Management Measures

Ammunition management requires careful planning and coordination by the MAGTF, artillery, infantry, and CSSE commanders and their staffs.

The tactical commander establishes a controlled supply rate (CSR) to govern maximum consumption of available supplies for a specified time or situation. Units allowed to exceed their CSR results in cutbacks for other units unless additional CSR is obtained from a higher command. Approval of CSR increases by a higher command can be waived in emergencies.

Expenditure limits placed on the type of fires or expenditure rates used during a particular phase of the operation identify suitable levels and prevent waste. The following are examples of limiting

ammunition expenditures and the responsible command level:

- Harassing and interdiction fires (established at MAGTF and division levels).
- Counterfires in conjunction with the establishment of attack guidance (established at MAGTF and division levels).
- During a particular phase of the operation (established at division and regiment levels).
- Preparation fires (established at any level planning preparation fires).
- In suppression missions (established at any level planning a suppression mission).
- Providing attack guidance to identify priority and method of engagement by type, and prohibit attack of certain types of targets (established at all levels).

Maintaining an accurate ammunition status is important in planning and establishing a responsive ammunition resupply system. An artillery unit's accurate recordkeeping identifies shortages before they become critical. Ammunition status reporting aids in establishing resupply priorities and forecasting subsequent consumption. Each echelon's ammunition recordkeeping procedures must be identified in planning if not contained in unit SOP.

The AMREP is developed as a result of recordkeeping and assists in the maintenance of ammunition status. It should be submitted frequently enough to allow for operation and resupply decisions, and can be used as a trigger in an automatic or push supply system. The AMREP normally reports ammunition on hand, deficiencies or excesses for basic loads, and anticipated heavy expenditures.

Class VI

Unit personnel deploy with personal demand items as prescribed by commanders at each echelon. Replenishment of these items is procured from the CSSE based on pre-established planning requirements.

Class VII

Class VII's basic load consists of a unit's table of equipment (T/E) items. During the development of load plans, nonessential T/E items may be palletized.

Class VIII

Medical supplies are drawn from the CSSE. Battalion and regiment aid stations are authorized medical allowance list (AMAL) blocks 635 (aid station equipment) and AMAL 636 (aid station consumables).

Class IX

Depending on maintenance requirements, repair parts are demand-supported. The S-4 coordinates with the CSSE to ensure adequate stock of artillery repair parts/kits for mission-essential items. Quick, on-site repairs can be accomplished through pre-expended bins; however, pre-expended bins are limited to low-cost, high-usage items.

Class X

This class of supply does not greatly affect planning. Class X supplies are procured from the CSSE when required.

Transportation

Embarkation, landing, and surface movement must be planned in detail. Units load to permit unloading according to the tactical plan. Access to supplies and equipment aboard ship must be ensured. Mobile loads must allow for immediate operations upon landing. The tremendous amount of supplies requiring transportation by artillery units and the number of lengthy convoys during displacement create a cumbersome logistic task. Coordination of landing support, such as matting, facilitates rapid off-loading and prevents overcrowding of the beach area. The status of road nets, weight limits of bridges, minefield marking, traffic control, and route priorities must be coordinated with higher headquarters and appropriate transportation control centers when planning transportation requirements.

Embarkation

The artillery unit embarkation officer provides embarkation requirements to the GCE as early in the planning phase as possible. The MAGTF II/Logistics Automated Information System family facilitates planning and execution of embarkation. The artillery unit embarkation officer establishes the necessary liaison; provides the GCE Marine air-ground task force (MAGTF) Deployment System II (MDSS II) embarkation data; and coordinates staging, material handling, shoring and dunnage, working party, and security requirements based on higher headquarters' guidance. See JP 3-02.2, *Joint Doctrine for Amphibious Embarkation*.

Organization for Embarkation

Artillery units may combine for embarkation or embark as attachments (in the case of a BLT or RLT) and divide into embarkation teams for each ship. The embarkation team consists of troops, equipment, and supplies embarked on a single ship. Artillery weapons, prime movers, and their crews embarked on the same ship for training and

maintenance while underway. The following artillery personnel embark with their supported units:

- Fire support coordination personnel with the supported unit.
- Liaison personnel with their assigned units.
- FO teams with their supported units.

Load Plans

Artillery build-up ashore (advance parties, batteries, and battalion command echelons) must be considered. Load plans address the composition of the reconnaissance party and provide for the establishment of survey control, communications, selecting battery positions, beach exits, route guides, and marking. The team embarkation officer prepares load plans in coordination with the ship's combat cargo officer. Ship's loading characteristics pamphlets (SLCPs) identify detailed loading characteristics of assigned ships. An inspection is made of stowage areas, holds, and decks to verify the data in the SLCP. The ship's CO approves the load plan before loading starts and approves required changes.

Helicopter Movement

Helicopters provide a means of mobility for towed weapons and a means of resupply for artillery units. Their use may be limited by availability, atmospheric conditions, and the threat. Successful movement of artillery by helicopter depends on the extent of coordination and reverse planning. The supported unit's air officer provides technical assistance. In addition to the concept of operations, major considerations include the following:

- C2 and face-to-face coordination.
- Organization of the unit in relation to the mission.
- Mobility of the unit once the helicopter lifts.
- Reconnaissance and selection of routes, loading areas, landing sites, and PAs.
- Preparation of helicopter employment assault landing tables.

- Resupply, survey, and met requirements.
- Threat situation.
- Use of division reconnaissance teams to determine the ground threat in the PA.

Helicopter movement of artillery units is conducted in four phases:

- The **planning phase** begins with the issuance of a warning order and continues through the commencement of the movement. It encompasses coordination with supported and supporting units, reconnaissance and selection of position, fire planning, and rehearsals if time permits.
- The **loading phase** consists of ground movement to appropriate pick-up areas; preparing the helicopter loading area; preparing troops, equipment, and supplies; and loading helicopters.
- The **movement phase** is the actual move from the loading area to the landing site. It begins with the take-off of the first helicopter and ends with the arrival of the last helicopter at the landing site.
- The **occupation of position phase** consists of establishing a helicopter landing site by an advanced artillery party, unloading personnel and equipment, and occupying the position. Appendix F contains detailed information on planning, organizing, and executing heliborne artillery raids.

Fixed-Wing Air Transport

Artillery units can be transported by fixed-wing aircraft. Detailed and flexible plans are required due to the different models of available aircraft, weather, distance, staging, material handling, dunnage, and shoring requirements.

Movement by Rail

Artillery units can be moved by rail. Planning factors that govern rail movement include the distance to be traveled, availability of railroad facilities, and priorities established by the tactical situation.

Motor Transport

Motor transport assets provide artillery the organic ability to move units to PAs, as well as a means for resupply. An artillery operation's demand for motor transport is increased by the vast tonnage of Class V(W) requirements, which necessitates detailed planning and efficient loading for maximum vehicle use.

Maintenance

To effectively plan maintenance support, the S-4 must know the availability of tools, test equipment, publications, and mechanics; determine maintenance concept; establish MCTs; and establish recovery and evacuation procedures.

Supply Support Planning

A review of activity usage data, experience, and anticipated requirements—based on the geographical area of the operation—provides a guide for planned maintenance requirements. Liaison with the CSSE will ensure sufficient quantities of artillery-specific items are stocked.

Maintenance Contact Team

An MCT is a temporary organization of organic assets consisting of one or more mechanics/technicians formed to accommodate a specific task. An MCT provides on-site maintenance or technical assistance, and diagnostics and repair part identification. To ensure the MST arrives with the required capability, the MCT informs the CSSE of parts, tools, and technicians required. The decision to use MCTs depends on the following:

- Equipment size, complexity, quantity, installation, and security classification.

- Distance from the maintenance area.
- Availability of qualified personnel and serviceable test equipment.
- Transportation and travel time.

Recovery and Evacuation Procedures

Artillery units have limited repair capabilities. Recovery policies, maintenance repair time criteria, and an evacuation policy must be established. Maintenance repair time criteria guides decisions of whether to attempt on-site repair or evacuate damaged equipment.

Collection points should be identified to speed evacuation. Collection points are designated points on the battlefield, normally along routes of march, at which inoperable equipment can be moved for further evacuation/disposition. The artillery S-4 coordinates collection point locations with the supported unit's S-4 and CSSE.

Health Services

Providing rapid treatment and evacuation of personnel must be carefully planned. Unit medical personnel are responsible for establishing lines of communication (LOC) with the GCE's and CSSE's medical activities. Casualty evacuation plans must consider the following:

- Means of transportation.
- Triage casualty evacuation priorities.
- Evacuation routes.
- Mass casualty handling procedures.

SECTION III. EXECUTION

Battalion Logistic Organization

The battalion's organization for support may be decentralized, centralized or a combination of both. This organization may change with the tactical situation.

Decentralized Support

Within the battalion, batteries may be required to maintain logistic capability using their organic assets. Decentralized support affords the battery commander maximum control and responsiveness; however, it has the following disadvantages:

- Vulnerability results from larger PAs and convoys.
- A signature effect may be produced by vehicles moving to and from the battery position.
- When logistic elements are replenishing, battery displacements may create difficulty in reconstituting the battery.

Centralized Support

When centralized support is established, it must not degrade the battery's ability to displace. Personnel, vehicles, and equipment may be centralized at the battalion level to provide logistics to firing batteries. Generally, a battery contains only the essential personnel, equipment, and supplies necessary to support operational requirements. Trains are established to provide logistic support to a firing battery. Centralization provides the battalion commander increased logistic flexibility.

Distribution

The artillery battalion will generally use unit and point distribution methods over the course of an

operation. The nature of the request, tactical situation, status of transportation assets, and volume of supplies requested will affect the type of distribution method used.

Unit Distribution

The supporting unit delivers the support to the supported unit. The supported unit is responsible for its internal distribution. This maintains the tactical positioning of the battery and reduces traffic flow. Vehicles stocked with POL and ammunition stop at each position for resupply. The battalion or GCE S-4 must coordinate with the battery being serviced to ensure tactical operations are not affected by movement to and from the firing position.

Point Distribution

The supported unit leaves its position to pick up requested support from the supporting unit area or other centralized location. This can involve vehicles leaving their tactical positions to enter an established RRP. An RRP is a pre-arranged or hastily position set up to support highly mobile units. An RRP request identifies the following:

- Unit requiring support.
- Class and quantity of the requirement.
- Type of support required; e.g., maintenance or engineer.
- Desired date and time of resupply.
- Route of march (start point and end point by grid) and link-up point.
- Coordinating instructions.

An RRP may be established to support a displacing battery at a coordinated point along the unit's established route of march. RRP's may be established to service multiple batteries in succession.

Supply Systems

The supply system provides the materiel required for operating forces to function. Continuous evaluation of supply levels must be made to determine possible changes. The S-4 must be aware of the unit's basic load and anticipate the extent and frequency of replenishment supply operations.

Changes in supply requirements are affected by projected tactical changes, troop/equipment density, consumption rates, and transportation availability.

Logistic summary reports, prepared by the S-4, provide the means to maintain supply status. Content and frequency are established by unit SOPs. Resupply can be accomplished by using a pull and push system.

Pull System

The using unit determines the need and forwards specific requests through logistic communication channels. The pull system will only provide those supplies ordered by the consumer and does not anticipate user needs.

Push System

The push system is an automatic resupply method. Data obtained from monitoring consumption rates are used to anticipate unit requirements. This system pushes supplies forward without a request, relieving the forward units of the logistic burden and/or potential shortage of supply. This allows the supporting unit to synchronize replenishment efforts. Care must be taken to avoid burdening the user with excess supplies.

Organization of Logistic Trains

The train concept is a means of internally task-organizing and employing organic logistic assets. Trains are the link between the batteries and the

supporting CSSE. This allows CSS to be performed as far forward as the tactical situation permits. Trains may be fully mobile or movable depending on the situation. The desired capabilities of the trains will dictate the size and may require consolidating some battery and/or battalion vehicles.

Battalion Trains

Battalion trains may be centralized into one entity or echeloned. Centralization places all the unit's logistic assets under the direct control of the commander under the cognizance of his/her logistics officer. It is most appropriate in defensive, slow-moving or static operations. Normally, battalion trains can be echeloned into combat trains and field trains. See table 9-10. This concept improves responsiveness, flexibility, and survivability against air attack.

Combat Trains

Combat trains provide critical organic logistics in forward areas. The key to combat trains is mobility. Trains are intentionally kept light so they can travel with supported forces. Combat trains usually include rations, fuel, ammunition, and MCTs with limited repair capability.

Field Trains

Field trains consist of the remaining organic logistic elements located further to the rear. Trains may or may not be mobile-loaded. They usually include the mess section; the supply section (-); some organic or attached motor transport; and a battalion aid station (BAS).

Regiment Trains

Regiment trains consist of the logistic assets required to sustain the regiment headquarters and any organic or attached units under the direct control of the regiment. The regiment commander may choose to consolidate battalion field trains in one location for security, control, and centralization of resources. Critical logistics support to lower units should be allocated to battalion trains, but noncritical support can be consolidated at the regiment level.

Table 9-10. Notional Composition of Battalion Trains.

Element	Capability	Quantity	Vehicle/Equipment
Combat Train	Supply		
	Class I	1	M923 w/M149
	Class V *	6-8	M923 w/M105
		3	Mk48 w/Mk17 or Mk14
		1	MC-4000
	POL **	1	M923 w/Sixcon
	Maintenance ***	1	M936
	Medical	1	M1035
	Other ****		
Field Train	Supply		
	Class V *		As required
	General	1	M923
	Maintenance	1	M936
	Medical (BAS)		Aid Station
	Administrative		As Required
<p>* Ammunition section accompanies the combat train as required. Vehicles represent those provided by the firing batteries and the headquarters battery. The ammunition section's train may operate independently from the combat train.</p> <p>** Augmentation of additional tankers from regiment may be required.</p> <p>*** May include MCTs or recovery equipment.</p> <p>**** Engineer, landing support, NBC equipment, and personnel as required.</p>			

Positioning Trains

The battalion S-4 selects train locations for logistic operations in coordination with the S-3. The main considerations for selecting a site are responsiveness and survivability. Combat trains are often located with the battalion CP. MCTs and task-organized elements of the combat train can be dispatched to provide support to the batteries. In general, trains should be located as follows:

- On defensible terrain.
- In an area with enough space to permit dispersion.
- In an area that provides concealment.
- On firm ground to support heavy/continuous vehicle traffic.
- Near a suitable helicopter landing.
- Close to MSRs.
- In an area that allows good communication.

Conducting Train Operations

Route Selection

The battalion S-4 selects the supply route for train operations based on METT-T and the method of distribution. The route extends forward to the batteries or positions between their current location and future PAs. Coordination with adjacent combat, combat support, and CSS units ensures movement of support assets. Alternate routes should also be selected. The S-4 notifies the S-3 of route selection.

Site Selection

The battalion S-4 determines a suitable location for the RRP. The S-4 notifies the battery of the location and time for resupply through the use

of an RRP response, which identifies the following:

- Unit being supported.
- Site location.
- Date and time of support.
- Coordinating instructions (including quantities if different from request).

The site selected should be on or near the battery's route of march. The site should not block the MSR. The S-3 uses checkpoints to identify the intended route and coordinates with the battery. The site should have an identifiable entry and exit.

Repair and Replenishment Point Organization

The location of each activity must facilitate movement of vehicles in an orderly flow. Time-consuming functions; e.g., refueling or ammunition transfer, should be positioned to allow simultaneous completion within the same RRP. Figure 9-2 illustrates a typical RRP layout.

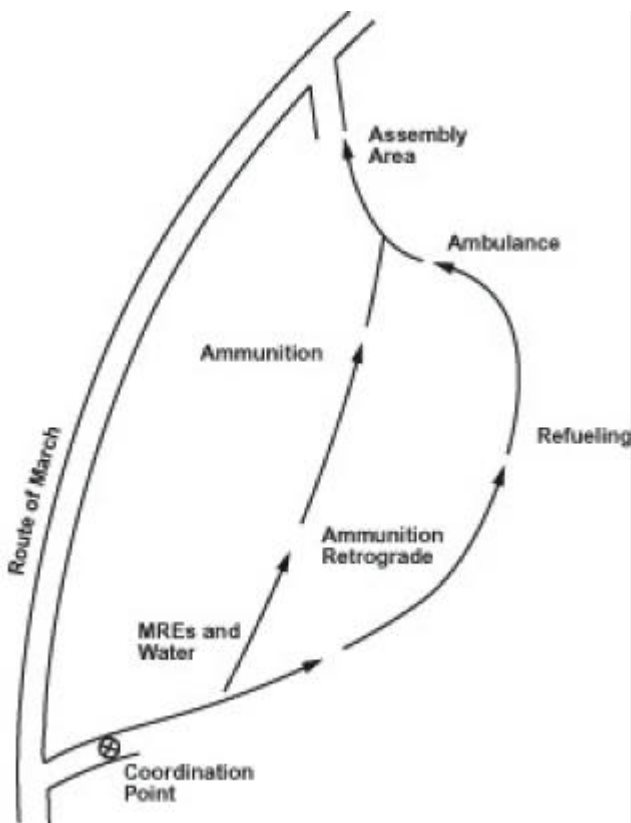

Figure 9-2. Replenishment and Repair Point Layout.

When the battery arrives at the RRP, designated personnel dismount at the coordination point to assist local security. Guides direct vehicles to their respective stations, and forklifts move forward to assist in resupply and ammunition loading.

The senior mechanic determines the vehicles to be evacuated and if they will be retained by the train. The unit must cross-deck equipment, supplies, and personnel onto another vehicle or shuttle.

Security

Security threats come from the air, bypassed threat units, infiltrators, guerrillas, indirect fire weapons, mines, and threat combat formations that have broken through forward units.

Regardless of military occupational speciality (MOS), every Marine is an infantry Marine and is expected to participate in establishing and maintaining security. Depending on the extent of the threat, security personnel may be provided from the battalion and/or the supported unit.

Reinforcement plans are established with adjacent or nearby units. Fire plans are prepared for the use of supporting arms. LPs and OPs are established for early warning and dissemination of threat information through intelligence channels. Because of limited personnel, potential threats must be addressed quickly to determine strength and direction of attack.

Train Security

Conducting replenishment operations under the cover of darkness, with special emphasis on light and noise discipline and radio silence, reduces the vulnerability of trains. Tactical convoy discipline must be practiced at all times. Well-rehearsed, immediate action drills for blocked and unblocked ambushes and attacks are critical. Personnel have individual weapons ready and are assigned areas of observation, including air observation. Crew-served weapons are positioned to respond to attacks. Train personnel establish all-around security during brief halts and in the

rear area. During extended halts, all personnel must undertake improved security measures.

Rear Area Security

Rear area security consists of passive defense measures and early warning. CSS elements may be collocated. Rear area security measures include dispersion, camouflage, noise and light discipline, cover and concealment, fortification, obstacles, and barriers.

Refueling Operations

A key to the refueling effort is for each unit/driver to refuel at every opportunity; e.g., during trips to the rear area. Special attention must be given to refueling ammunition-hauling vehicles. Coordination is essential to refuel these vehicles as they routinely move to and from the ammunition supply point (ASP). Fuel should be recovered from disabled vehicles whenever possible. Packaged grease and lubricants are obtained through normal supply channels and distributed as required. Generally, refueling operations are carried out as follows:

- Vehicles alternate to a centrally located fuel site.
- Fuel is provided by battalion, regiment, and/or CSSE tankers.
- Vehicles refuel during RRP operations.

Ammunition Operations

Ammunition resupply is one of the most vital logistic operation for an artillery unit. A properly functioning Class V(W) support system provides the correct type and quantity of ammunition at the proper time and place. The system is tailored to fit the needs of the unit and incorporates the positioning of resources, maintenance of status, and concept of support. The Class V(W) support system adjusts to changes in the tactical situation, fire plan, and ammunition plan. Frequent

and continuous coordination between the supported unit and CSSE is essential.

CSSE Responsibilities

The CSSE maintains ammunition stocks at various locations and delivers ammunition to the supported GCE. The artillery commander must make frequent, accurate projections of ammunition requirements to the GCE commander to allow time for repositioning and prioritizing resupply efforts.

Ammunition operations transfer ammunition to artillery resupply vehicles to support the periodic or daily resupply needs of units. Successful ammunition operations require interface between the CSSE and the artillery unit to supervise the timing of deliveries and loading of vehicles with the proper type of ammunition. Artillery units should provide an individual knowledgeable in ammunition handling; e.g., projectile/fuze combinations, to function as an ammunition officer when interfacing with the CSSE. Frequent coordination between the artillery S-3 and S-4 and the ammunition officer allows for responsive resupply of ammunition in the required quantities and types.

Ammunition Company, Supply Battalion

The ammunition company is assigned the mission of establishing ammunition dumps and operating supply points for Class V supply. The company provides detachments to DS and GS CSSEs for ammunition operations.

The FSSG or detachments provide combat supply and maintenance support for chemical weapons. The supply battalion stocks special types of Class V items and provides detachments specialized in assisting supported units. Chemical weapons require special consideration in combat operations, especially with respect to safety, security, transportation, and handling. The supply battalion performs all functions incident to the receipt, storage, issue, and fielding of chemical material.

Ammunition Supply Point

An ASP is a supply activity established by the CSSE for receipt, storage, assembly, issue and/or distribution; limited salvage; and surveillance of Class V items. Supported ASPs are normally assigned GS. A stock level is maintained at the ASP with a specified quantity, but the level may vary with operation requirements.

Artillery Battalion Responsibilities

Ammunition Vehicle Load Plans

Vehicle load plans are developed around the basic load of ammunition, as this constitutes the greatest transportation demand. Load plans are developed for ease of access to supplies. The load plan facilitates replenishment of the gun sections and resupply of the vehicle itself. A vehicle is designed to carry a single type and lot of ammunition, if possible. The basic load of ammunition may require units to carry only mission-essential equipment. Non-essential equipment can be palletized and staged for later use. In dynamic operations, the ammunition is serviced from mobile-loaded vehicles for frequent displacement. In static operations, there may be a requirement to download ammunition in order to free vehicles for replenishment.

Ammunition Train Composition

After load plans are developed, transportation assets are designated in support of the resupply effort. Designated vehicles form an ammunition train.

Tailored Ammunition Packages

An ammunition package's content is based on experience, unit requirements, and flexibility. The artillery commander uses ammunition packages tailored to enhance artillery effectiveness to the supported unit. Tailored ammunition packages allow for greater quantities of high usage munitions to be carried on ammunition vehicles. Low usage ammunition; e.g., FASCAM, may be carried by a designated battery or section. This allows other

units to adjust their basic load to carry greater quantities of high usage ammunition.

Ammunition Resupply and Delivery

A basic principle for responsive ammunition support is positioning supplies as far forward as possible to reduce turnaround time. This is achieved by establishing unit priority for delivery and selecting the method of resupply based on the tactical situation.

Ammunition may be delivered directly to battery positions by the regiment, battalion or CSSE. Distribution to batteries depends on the location, configuration of the position, and the ability to download ammunition. Helicopters can also provide transportation.

Exchanging loaded vehicles from the battalion ammunition train with empty vehicles of a battery's ammunition section reduces handling and turnaround time for the train. Pre-configured ammunition packages and vehicle load plans facilitate this exchange. This technique is particularly adaptable to high usage munitions.

Pre-positioned Ammunition Stock

Ammunition is downloaded at batteries or battalions as a means of pre-positioning ammunition in the forward area. Based on anticipated requirements, ammunition is moved forward during lulls. In defensive operations, stockpiles in battery areas support periods of increased expenditure such as counter-mechanized fires. In offensive operations, a series of stockpiles may be established in battery positions, as well as future positions, to support assault expenditures. If circumstances preclude the expenditure of pre-positioned quantities, ammunition is reported as excess and then re-allocated.

Unit Ammunition Supply Points

Artillery units in forward areas may form unit ASPs. The reduced turnaround time for resupply offsets the required download of ammunition.

Ammunition is brought in by CSSE convoys, helicopters, and/or artillery trains. Unit ASPs can function from loaded vehicles and/or stockpiles on the ground. Developing a plan for loading prime movers and trailers in separate areas for simultaneous loading can save time. To control congestion, the commander establishes unit priority for entering the site and using MHE.

Ammunition Management

Ammunition management is a continuous process performed by all units during a battle. Accurate recordkeeping is a critical part of ammunition management and must be practiced by all artillery units.

Weighting the Main Effort

Assigning priorities occurs by designating an element to receive priority of fire or establishing a priority to a particular type of fire; e.g., counterfire. Identifying priorities for unit resupply that require the availability of sufficient supply levels and the time and means for distribution can also be used.

Unit Interaction

Interaction between supporting and supported staffs must be emphasized. Unit commanders providing fire support must be informed of possible plans that require large quantities or special types of ammunition. Supporting commanders stay abreast of possible courses of action to coordinate support.

Controlling Ammunition Issue

Maximum effort must be given to issuing ammunition by lot segregation. Issuance and distribution of the minimum lots of projectiles, propellants, and fuzes contribute to the gunnery solution and maximize available carrying capacity. Recording the ammunition lot includes condition, performance, and accidents involving ammunition.

Gunnery and Weaponing Application

Prudent fire support planning, fire planning, and fire direction contribute to sustaining operations.

Sound fire direction techniques reduce the need for survivability moves, increase ammunition effectiveness, and reduce the logistical burden of ammunition resupply.

Supply Rate Evaluation

RSR and ASR evaluation is a continual process. The responsible unit forecasts expenditures so that sufficient quantities, transportation, and time are available to provide the required support.

Basic Load Evaluation

The basic load and its method of transportation may change to meet the tactical situation.

Maintaining Technically Qualified Personnel

Qualified personnel must be maintained at various command levels to assist in the planning and operation of Class V(W) support operations.

Supply Economy Enforcement

Restricting and controlling firing practices conserves supplies and reduces the logistical burden of ammunition resupply. Firing needs should be determined, fire plans established, and target priorities set to control the need for resupply.

Contingency Planning

The commander may set aside a portion of available supplies for emergencies or to help support the exploitation of an unexpected opportunity.

Maintenance Operations

A unit's ability to sustain combat operations rests on the ability to perform ongoing maintenance. An effective maintenance program must incorporate allocating of personnel and time, the availability of repair parts and tools, and command emphasis at all levels. Commanders ensure that equipment is properly maintained by personnel under their control. Commanders monitor maintenance

programs to ensure preventive maintenance (PM), which minimizes failures and ensures the smooth flow of repair parts and equipment for corrective maintenance (CM) when failures occur.

Maintenance Support

Organizational maintenance is performed as far forward as the tactical situation allows and keeps the equipment in the hands of the user. The commander establishes a maintenance program to maximize assets. Battalion or regiment MCTs or CSSE maintenance support teams (MSTs) may perform or assist in on-site malfunction diagnoses, adjustments, alignments, repair or replacement of end items or major assemblies. Adequate stock of repair parts is required to support the maintenance effort. High usage parts should be held as far forward as possible.

Preventive Maintenance

The PM program includes systematic servicing and inspection, correcting failure before damage occurs, and proper equipment use. Early and thorough PM prevents minor discrepancies from becoming major problems requiring extensive repair.

Corrective Maintenance

When equipment becomes inoperable, it should be repaired on-site at the lowest possible level. Battery-level maintenance is limited to certain organizational maintenance services and minor repairs. The exact responsibility for repair of an item of equipment is largely determined by the type of equipment.

For vehicles, the S-4 will coordinate with the battalion motor transport officer to dispatch an MCT. Repairs will be made on-site, if possible. If the repair requires intermediate level maintenance, the MCT will request a CSSE MST via the S-4 to repair the vehicle on site, if possible. If a vehicle cannot be repaired, it is evacuated and repaired at the battalion. If evacuation is hampered by lack of

time or capability, the vehicle may be moved to a maintenance collection point along the supply route where it is picked up by the CSSE.

Organizational maintenance of communications-electronics equipment is performed by trained technicians within the artillery unit. On-site repair is preferred.

Engineer equipment mechanics and electrical equipment repairmen are provided by the regiment. Qualified maintenance personnel attached to the using unit conduct second echelon maintenance or an MCT is dispatched from the regiment engineer section. The regiment engineer section is responsible for evacuating inoperable engineer equipment.

For ordnance equipment, the individual/crew, battery armorers or artillery mechanics perform weapon repair. If these individuals cannot repair the weapon, a CSSE MST is requested for on-site weapon repair. If on-site repair is not feasible, the weapon is evacuated.

Maintenance Site Selection

Maintenance site selection is governed by the following fixed, physical characteristics: terrain, weather, tactical situation, unit size and mission, and the mission's maintenance requirements.

The maintenance area must be large enough to disperse equipment and maintenance activities.

The terrain should favor defense against air or ground attack; facilitate local security; hard stand for vehicles and equipment; and accessibility to road, water, and air routes for evacuation and resupply.

Access routes should avoid congested areas, be convenient to maintenance facility users, and be accessible to MSRs. Easy access to supported units and evacuation of equipment are critical elements.

The site should be positioned to allow the maintenance activity to effectively perform its mission. It should be located far enough from the supported

combat elements to allow continuity of maintenance operations.

An attempt should be made to locate in close proximity to other unit logistical elements to enable common facilities and services.

Recovery and Salvage

Commanders are responsible for the recovery of their disabled vehicles to make repairs and prevent destruction or capture. Recovered vehicles are inspected, repaired, and placed in operation at the lowest level possible. If a vehicle cannot be repaired, it is reported as disabled. The report includes the location, number and type of vehicles, and conditions. Battery collected salvage materiel is evacuated to a battalion collection point by vehicles making supply trips to the rear. Battalions usually operate a collection point in the vicinity of their maintenance area. Salvaged, excess, and damaged items evacuated to the battalion are turned in for evacuation to CSSE. Vehicles that cannot be repaired are removed from the traffic pattern. The location and condition of these vehicles are reported to higher headquarters through logistic channels.

Captured Materiel

Captured materiel is collected and evacuated under S-2 supervision. Captured materiel is always reported to the next higher headquarters where it provides a source of intelligence information.

Equipment Destruction

The decision to destroy equipment is made only on approval delegated by higher authority. When ordered, destruction is accomplished quickly, efficiently, and uniformly. Plans for destruction should be prepared in advance and incorporated into unit SOPs.

Cannibalization

Cannibalization is limited to the exchange of serviceable/unserviceable parts between like

items of unserviceable equipment within the same battery/battalion. Cannibalization is performed only in specific conditions established by the MAGTF commander.

Engineer Operations

Engineer operations include preparation/hardening of unit positions; utility support; and NBC material handling and decontamination support. Artillery units may receive support from several sources, including the regiment engineer section, division engineers, and/or the CSSE.

Battery Position Preparation

The more preparation a position receives, the longer the battery can remain in place; hence, its fire support is more effective. Artillery commanders establish work priorities based on an analysis of threat capability. Position improvement is continuous.

Vehicle Positions

Vehicle positions are prepared to protect essential vehicles such as ammunition, supply, maintenance, communications, decontamination equipment, and refuelers. Positions are randomly placed throughout the battery area. The vehicle pit is designed with an opening on each end for drive-in access/egress or with a rear wall having only one entrance. The vehicle pit is deep enough to position the top of the vehicle at least 1 foot below the surrounding walls. Positions can be deep-cut or constructed with a soil parapet to reduce the pit's depth. Camouflage netting is placed across the position.

Weapon Emplacements

Weapon emplacements provide additional protection for prolonged occupation. For towed artillery, the emplacement should be constructed

using minimum excavation and a surrounding parapet to achieve the desired level of protection. The position may require constructing a firing platform, usually of M8A1 matting. The position should be as level as possible, allow for direct fire capability, and permit rapid exit. Sighting requirements (aiming circle or aiming posts, etc.) of the weapon must be considered. The use of overhead cover for the weapon is difficult to provide without restricting the firing capability. Emplacement dimensions vary with the weapon type and the positioning of prime movers. See table 9-11.

Ammunition Shelters

Ammunition shelters should be located and constructed to protect ammunition against the weather and threat fire. They should be large enough to hold the desired quantity of ammunition close to the firing position. They can be constructed in a weapon emplacement parapet. If it is necessary to construct an ammunition shelter above ground, particularly where there is a high water level, a log crib built up with dirt is suitable. Building defensive positions for concealment is a command function, not a logistic function.

Table 9-11. Artillery Vehicle Position Dimensions.

Vehicle Type	Dimensions (ft)			Equipment Hours **	Minimum Parapet Thickness (ft)
	Length	Width	Depth *		
M198	60	60	3	1.5	8
M813/923 Truck	38	14	5	1	3
w/M105 Trailer	50	12	5	1.5	3
1¼ - ton Truck	20	13	9	0.7	2
* Total depth includes any parapet height. For deep cuts, double the depth and construction time. All depths are approximate and will need adjustment for surrounding terrain.					
** Divide construction time by .85 for rocky soil, hard soil or night conditions. Use of natural terrain features will reduce construction time.					

CHAPTER 10

DEVELOPING THE ARTILLERY FIRE PLAN

SECTION I. ESSENTIAL FIRE SUPPORT TASKS AND ESSENTIAL FIELD ARTILLERY TASKS RELATIONSHIP

General

The artillery fire plan is a tab to the fire support appendix of the supported unit's OPORD. The artillery fire plan is the artillery commander's tactical plan for employing the fires of all available supporting artillery. It is based on the guidance and instructions from the fire support appendix of the supported unit's OPORD, supplemented by verbal information received from the liaison personnel in the FSCC.

The artillery fire plan ensures the most efficient use of artillery support by providing coordinated actions to carry out the decisions of the artillery commander in support of maneuver elements. The use of essential fire support tasks (EFSTs) ties the artillery fire plan to the maneuver plan. It is also used as a stand-alone document for artillery units in R, GS-R, and GS missions. The operations officer of the supporting artillery unit prepares the plan. Section IV is a sample artillery fire plan.

Essential Fire Support Tasks

The FSC uses the specified or implied tasks identified during mission analysis, commander's intent, commander's guidance pertaining to fire support, high payoff targets, and scheme of maneuver for a specific COA to identify specific fire support tasks. The FSC must then assign each fire support task to specific supporting arms agencies. These tasks frame the role of supporting arms agencies in

the overall plan and serve to focus their efforts in supporting the scheme of maneuver and the supported commander's intent.

Tasks should describe the intended fire support effect by delaying, limiting, disrupting or destroying a specific threat function or capability to support friendly maneuver.

Because timing of fires with maneuver is essential, the FSC must develop and articulate timing of fires with relation to maneuver. This can be event-driven (triggered by anticipated friendly or threat actions) or at a particular time on a universal clock (preparation fires, SEAD, etc.). A combination of both techniques may be used.

Tasks should also be measurable so their success or failure can be assessed and reasoned decisions made for re-attack. To make the most efficient use of fire support capabilities, these tasks must contain a sufficient level of specificity for the supporting arms agency to clearly understand its role in supporting the scheme of maneuver.

See MCWP 3-16 for a detailed discussion on development of fire support tasks as they relate to artillery.

Essential Field Artillery Tasks

The fire support tasks that the maneuver commander identifies to be accomplished by artillery become essential field artillery tasks (EFATs) for the supporting artillery unit. The artillery staff planning process enables the FSC and staff to

ensure that the necessary support is provided in the form of the right targets, attacked with the best available munitions, at the correct time, and in synchronization with the maneuver plan. Just as fire support tasks use the task, purpose, method, effect (TPME) methodology, EFATs use TPME to ensure that the EFST is accomplished in support of the maneuver plan. See figures 10-1 and 10-2.

The *task* describes the targeting objective fires must achieve against a specific threat formation's function or capability. See MCWP 3-16.

The *purpose* must clearly tie the EFAT to the fire support task it supports. It is a statement of the fire support task relative to maneuver.

The *method* is a concise statement of how the artillery task will be accomplished to include what must be done to complete the EFAT. This entails describing priorities of fire and survey; PAs and routes to them; AoFs; target numbers, priority targets & FPFs; radar zones; triggers for movement/survivability move criteria; and FSCMs. These are referred to as priorities, allocations and restrictions.

Effects describes what success will look like. As much as possible, quantify the effect as a measurable result. Describe the firing element's location; i.e., will the battery move after executing the task?

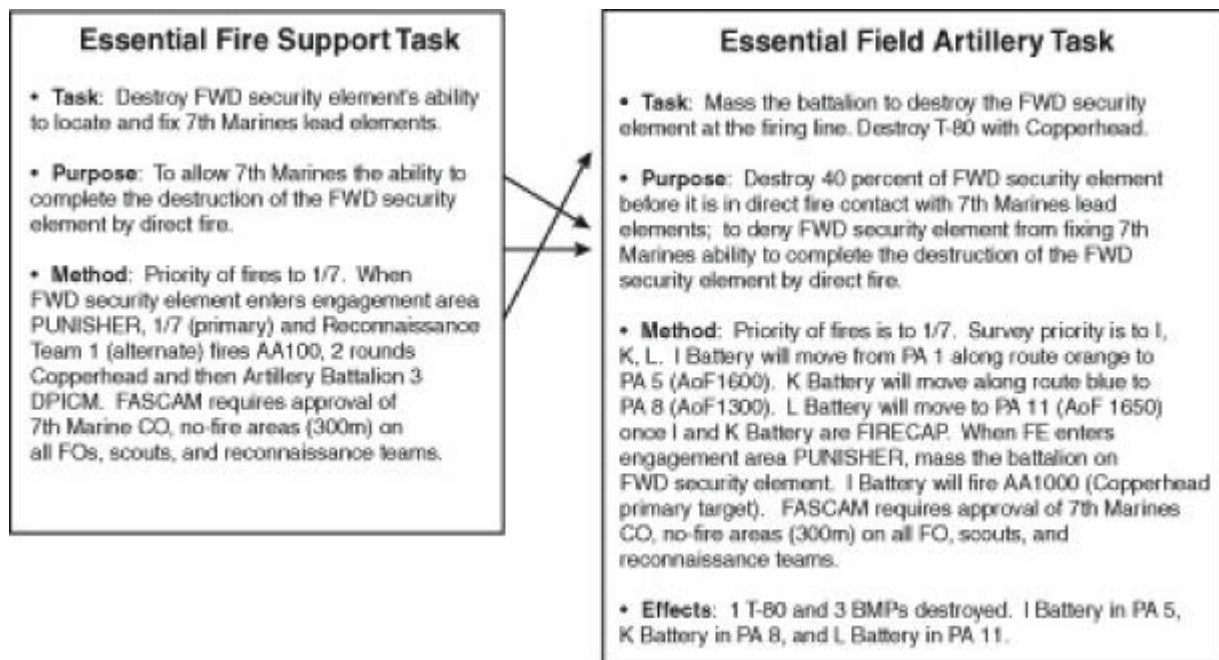

Figure 10-1. Essential Fire Support Tasks and Essential Field Artillery Tasks Relationship.

Task	Purpose	Method	Effects
Mass Battalion	Same as the purpose addressed with the EFST.	Batteries in place at grid _____ ready to fire not later than _____. Target number is _____. Number of rounds fired at target is _____. Trigger to fire mission is _____. Conduct survivability move to grid _____ immediately upon completion of mission. Ensure battery has current met. Battery conducts mass pre-combat check.	Same as the effects addressed with the EFST.
Fire FASCAM	”	Emplace FASCAM medium density (200 x 800). Low angle, 8 RAAMS aim points, 4 ADAM aim points; use one howitzer/aim point technique. Ensure RAAMS complete before firing ADAM. Minefield requires 96 RAAMS (12/aim point) and 24 ADAM (6/aim point). Batteries in place at grid _____ ready to fire not later than _____. Ammo section delivers 96 RAAMS and 24 ADAM to grid _____ not later than _____. Trigger to fire FASCAM minefield is _____. Conduct survivability move to grid _____ immediately upon completion of mission. Ensure battery has current met. Battery conducts FASCAM pre-combat checks.	”
Fire SADARM	”	Batteries in place at grid _____ ready to fire not later than _____. Target number is _____. Number of rounds fired at target is _____. Trigger fire mission is _____. Conduct survivability move to grid _____ immediately upon completion of mission. Ensure battery has current met. Remind battery uses altitude correction. Battery conducts SADARM pre-combat check.	”
Fire Copper-head	”	Batteries in place at grid _____ ready to fire not later than _____. Target number is _____. Number of rounds fired at target is _____. Trigger to fire mission is _____. Conduct survivability move to grid _____ immediately upon completion of mission. Verify pulse repetition frequency code with observer. Verify Angle T; confirm observer location. Verify gun target range check observer target range. Battery conducts Copperhead pre-combat check.	”
Fire Illumination	”	Batteries in place at grid _____ ready to fire not later than _____. Target number is _____. Confirm 1 gun illumination, range spread, lateral spread or range and lateral spread. Number of rounds fired at target is _____. Trigger to fire mission is _____. Conduct survivability move to grid _____ immediately upon completion of mission. Ensure battery has current met. Confirm observer location. Ensure the correct height of burst is used. Battery conducts illumination pre-combat check.	”
Fire Smoke	”	Batteries in place at grid _____ ready to fire not later than _____. Target number is _____. Length of smoke screen is _____. Attitude of smoke screen is _____. Wind direction is _____. Consult appropriate Pasquill table and compute initial volley and sustaining rounds. Compute aim points. Number of rounds fired at target is _____. Trigger to fire mission is _____. Conduct survivability move to grid _____ immediately upon completion of mission. Ensure battery has most met. Battery conducts smoke pre-combat check.	”

Figure 10-2. Example Essential Field Artillery Tasks.

SECTION II. THE MARINE CORPS PLANNING PROCESS AS IT APPLIES TO THE ARTILLERY FIRE PLAN

General

The Marine Corps Planning Process (MCP) consists of six steps. Each depends on the inputs from the previous step. See figure 10-3. Poor staff planning performed early in the process will escalate throughout the entire process and could result in commanders determining inaccurate COAs. The MCP improves staff coordination because of the natural framework of the process.



Figure 10-3. Steps in the Marine Corps Planning Process.

Mission Analysis

The first step in the MCP is mission analysis. This step drives the entire MCP and allows the artillery commander to begin his/her commander's battlespace area evaluation (CBAE). Each of the six steps in the MCP can be best understood from the perspective of inputs, process, and outputs. Figure 10-4 depicts this perspective for mission analysis. The artillery commander and his/her staff begin their planning upon receipt of a warning order from higher headquarters. Included

with this warning order should be their IPB, staff estimates, and facts and assumptions. The artillery commander and his/her staff utilize this information as inputs into their planning process.

Analyze Higher Headquarter's Order

This is higher headquarters' warning order. The need for concurrent planning does not allow the artillery staff to wait for the completed maneuver order before they begin planning. Understanding where the operation will occur and the type of operation will allow the staff to begin the MCP.

Conduct the Initial Intelligence Preparation of the Battlespace

The cornerstone of the MCP is the S-2's IPB. Each staff member depends on the S-2 to provide an accurate estimation of how the threat will fight before performing his/her portion of the MCP for the commander. The IPB process for maneuver units is outlined in MCWP 2-12, *MAGTF Intelligence Production and Analysis*.

Determine Specified, Implied, and Essential Tasks

The concepts of specified and implied tasks are the same as those used by the maneuver regiment staff. Examples of specified tasks are: position well-forward; move behind maneuver task force; plan CFZ at breach site; preposition smoke/RAP forward. EFATs for artillery units are derived from the fire support tasks in the maneuver fire plan.

Review Available Assets

The artillery commander and his/her staff must examine additions to and deletions from the tactical situation, current task organization, support

Inputs	Process	Outputs
Commander's orientation	Analyze higher HQ warning order	Initial IPB products
CBAE	Conduct the initial IPB	Restated mission
Commander's initial guidance	Determine specified, implied, and essential tasks	Commander's intent
Higher headquarters warning order or OPORD	Review available assets	Commander's guidance
Restrains	Determine constraints	Warning order
Higher headquarters IPB	Identify critical facts and assumptions	Specified tasks
Staff estimates	Determine initial CCIRs	Implied tasks
Facts and assumptions	Determine initial reconnaissance annex	Essential tasks
	Plan use of available time	Restrains
	Write the restated mission	Assumptions
	Conduct a mission analysis briefing	Initial staff estimates
	Approve the restated mission analysis briefing	
	Develop the initial commander's intent	
	Issue commander's guidance	
	Issue warning order	
	Review facts and assumptions	

Figure 10-4. Mission Analysis.

relationships, and status (capabilities and limitations) of all units. They consider the relationship between specified and implied tasks and available assets. From this they determine if they have the assets to perform all specified and implied tasks. If there are shortfalls, they identify additional resources required for the mission's success. The staff must pay particular attention to deviations from what the commander considers his/her normal task organization. Some examples of assets that may be considered are: radars, observers, reinforcing or GSR units to be included in a fire plan.

Determine Constraints

A higher artillery commander may place some constraints on his/her subordinate commanders that restrict their freedom of action. Constraints may take the form of a requirement to do something; e.g., maintain at least 25 percent of ICM or no smoke or dud-producing munitions on the eastern-most objective.

The commander and his/her staff must identify and understand these constraints, which are normally found in the concept of operations or coordinating instructions paragraphs from the maneuver operation plan.

Identify Critical Facts and Assumptions

Facts are statements of known data. Assumptions are suppositions concerning the current or future situation that are assumed to be true in the absence of facts. They take the place of necessary, but unavailable, facts and fill the gaps in what the commander and staff know about a situation. The tests of validity and necessity are a technique to use. Validity means the assumption is likely to be true. Necessity is whether or not the assumption is essential for planning. If planning can continue without the assumption, it is not necessary and should be discarded. Whenever possible, assumptions are cleared with the higher headquarters to ensure

consistency with higher headquarters' plan. Assumptions are replaced with facts as soon as possible. Assumptions should answer the following four questions: *Is it logical? Is it realistic? Is it essential for planning to continue? Does it avoid assuming away a threat capability?* To determine assumptions, planners should—

- List all appropriate assumptions received from higher headquarters.
- State expected conditions over which the commander has no control but which are relevant to the plan.
- List conditions that would invalidate the plan or its concept of operations.

Determine Initial Commander's Critical Information Requirements

Commander's critical information requirements (CCIRs) identify information needed by the commander to support his/her CBAE and to make critical decisions, especially to determine/validate courses of actions. See figure 10-5.

CCIRs should be limited to 10 items or less. CCIRs are time-sensitive in that they drive decisions at decision points (DPs). The key question is, "What does the commander need to know in a specific situation to make a particular decision in a timely manner?" The staff

COMMANDER'S CRITICAL INFORMATION REQUIREMENTS (CCIR)		
MISSION EXECUTION CHECKLIST		
Codeword	Time	Event
<p>Air Alert Status: _____</p> <p>NBC Alert Status: _____</p> <p>MOPP Level: _____</p>	<p>HOT ITEMS:</p> <p>1. _____</p> <p>2. _____</p> <p>3. _____</p> <p>4. _____</p> <p>5. _____</p>	

Figure 10-5. Commander's Critical Information Requirements.

nominates information requirements (IRs) to become CCIRs. CCIRs are situation-dependent and specified by the commander for each operation. He/She must continuously review CCIRs during the planning process and adjust them as situations change.

CCIRs usually arise from the IPB and war gaming. CCIRs are normally expressed as priority intelligence requirements (PIRs)—information about the threat; essential elements of friendly information (EEFI)—information needed to protect friendly forces from the threat’s information-gathering systems; and friendly forces information requirements (FFIRs)—information about the capabilities of his/her/her or adjacent units. The staff should also attempt to identify the threat’s center of gravity. Center of gravity—it is that characteristic, capability or location from which threat and friendly forces derive their freedom of action, physical strength, or the will to fight. Attacking the center of gravity is—or should be—the focus of all operations.

Determine the Initial Reconnaissance Annex

Based on the initial IPB and CCIR, the staff, primarily the S-2, identifies gaps in the intelligence available and determines an initial reconnaissance and surveillance plan to acquire information, bring forward higher order survey, position observers or send out advance parties. The S-3 molds this into an initial reconnaissance annex to launch assets as soon as possible to begin their collection efforts. This initial reconnaissance annex should contain—

- The AO for reconnaissance.
- Mission Statement.
- Reconnaissance objective.
- Line of departure/line of contact time.
- Routes to AO and passage of lines instructions.
- Fire support measures.
- Task organization.

- PIR and IR.
- Initial named areas of interest (NAIs).
- Communications and logistics support.
- MEDEVAC.

Plan Use of Available Time

The artillery commander and his/her staff refine their initial plan for use of available time. They compare the time needed to accomplish EFATs to the maneuver time line to ensure mission accomplishment is feasible in the allotted time. They also compare the time line to the threat time line developed during the IPB. The commander and his/her staff specify when and where they will conduct the briefings that result from the planning process and when, where, and in what form they will conduct rehearsals. The artillery commander can optimize planning time by sending additional warning orders as detailed planning develops. This permits parallel planning by subordinate units.

Write the Restated Mission

The purpose of artillery and EFATs is the foundation for mission statement development. Planners should evaluate whether or not the purpose of artillery and EFATs is still valid before writing a restated mission. A proper mission statement answers the following questions—

- **Who**—The artillery units that will conduct the operation.
- **What**—The type of operation or EFAT.
- **When**—The time the operation will start and end.
- **Where**—The location of the battlespace or area of operation the artillery must support.
- **Why**—The purpose of the operation.

The “*who*,” “*what*,” “*when*,” and “*where*” are derived from the EFATs. The “*why*” is derived from the **purpose** of the *fire support task*.

Conduct a Mission Analysis Brief

The mission analysis briefing is not a unit readiness briefing, but staff officers must know the status of subordinate and supporting units and brief relevant information as it applies to the situation. The staff should use standardized charts to monitor/consolidate this data to give the commander a quick snapshot of his/her unit. The mission analysis briefing is given to the commander and his/her staff. This is often the only time the entire staff is present, and the only opportunity to ensure that all staff members are starting from a common reference point. The briefing focuses on relevant conclusions reached as a result of the mission analysis. This helps the commander

and his/her staff develop a shared vision of the requirements for the upcoming operation. *Time permitting, the staff briefs the commander on its mission analysis using the same outline discussed previously.* See figure 10-6 for an example mission analysis briefing format. See figure 10-7 for a mission analysis briefing checklist. The mission analysis brief includes the following:

- Mission and commander’s intent of the headquarters two levels up.
- Mission, commander’s intent, concept of the operation, and deception plan/objective of the force.
- Review of commander’s initial guidance. Initial
- IPB products.

<p>S-3: Introduction and Orientation</p> <p>S-2: Initial Intel Estimate Terrain Analysis • MCOO • KOCOA Weather Analysis • Forecast • Light Data/Night Vision Goggle Windows • Effects on Friendly/Threat Threat Evaluation • Enemy Order of Battle – Maneuver Forces – Artillery • Threat Most Likely COA • Threat Most Dangerous COA • Threat Timelines • Artillery Range Fans Proposed CCIR: PIR, FFIR, EEF1</p> <p>S-3: Operational Overview Higher Commander’s Concept Operation Task Organization Assumptions Requirements for Special Munitions, Movement, LNO ROE, FSCMs, Ammunition, and CSR Limitations and Risk Management</p> <p>S-3 Assistant: Fire Support Tasks</p> <p>S-1 Personnel Status Anticipated Personnel Status Personnel Shortages Critical Shortages Forecasted Losses</p> <p>S-4 Class I, II, IV, II, VIII, IX MSRs Issues Battery Ammunition Status ASP Status</p>	<p>FDO IFSAS/AFATDS/LCU Status Communications with Observers/Higher Range to Target Considerations Terrain Considerations Essential Field Artillery Tasks</p> <p>S-6 Communications Status Anticipated Communications Status (potential problems due to range and/or terrain) Retransmission Status and Plan</p> <p>NBC Defense Officer NBC Defense Equipment Status Contaminated Areas/Projected Strikes Current MCOO Status Proposed Decontamination Sites Contaminated Routes (Dirty Routes) Uncontaminated Routes (Clean Routes) Recommendations</p> <p>Survey Officer Priority of Survey Equipment Status</p> <p>Surgeon Ambulance Status Medical Support Provided Class VII Status Aid Station Location</p> <p>S-3 Proposed Restated Mission (Approval) Artillery Fire Plan Timeline Commander’s Guidance Issue Warning Order to Subordinate Units • Restated Mission • Directed Rehearsal Requirements • Orders Timeline</p>
--	--

Figure 10-6. Example Mission Analysis Briefing Format.

<p>S-1</p> <ul style="list-style-type: none"> <input type="checkbox"/> Current personnel status <input type="checkbox"/> Anticipated personnel status <input type="checkbox"/> Critical shortages <input type="checkbox"/> Personnel shortages <input type="checkbox"/> Forecasted losses <input type="checkbox"/> Forecasted issues <input type="checkbox"/> Issues 	<p>S-2</p> <ul style="list-style-type: none"> <input type="checkbox"/> Prepare/refine artillery MCOO <input type="checkbox"/> Prepare threat situational template <input type="checkbox"/> Prepare event template (time available?) <input type="checkbox"/> Determine enemy order of battle <input type="checkbox"/> Maneuver forces <input type="checkbox"/> Develop enemy order of battle <input type="checkbox"/> Determine avenues of approach <input type="checkbox"/> Determine weather and its effects <input type="checkbox"/> Forecast <input type="checkbox"/> Light data/night vision goggle windows <input type="checkbox"/> Prepare threat courses of action <input type="checkbox"/> Most likely <input type="checkbox"/> Most dangerous <input type="checkbox"/> Prepare recommended CCIRs <input type="checkbox"/> Determine radar status <input type="checkbox"/> Issues
<p>S-3</p> <ul style="list-style-type: none"> <input type="checkbox"/> Division and regiment missions received <input type="checkbox"/> Regiment commander's intent received <input type="checkbox"/> Fire support appendix of regiment order received <input type="checkbox"/> Regiment OPORD received <input type="checkbox"/> Field artillery organization for combat identified <input type="checkbox"/> Identify key facts and assumptions <input type="checkbox"/> Identify specified tasks: <ul style="list-style-type: none"> Essential fire support tasks Tasks to subordinate units Target list Special munitions requirements? 	<ul style="list-style-type: none"> <input type="checkbox"/> Identify implied tasks: <ul style="list-style-type: none"> Ranging requirements Movement requirements Passage of lines Liaison requirements? Special munitions requirements? <input type="checkbox"/> Identify essential tasks <input type="checkbox"/> Identify constraints: <ul style="list-style-type: none"> Position restrictions Movement restrictions Observed versus unobserved fires Special ROE requirements Ammunition or CSR limitations <input type="checkbox"/> Required Controls? <input type="checkbox"/> Prepare order preparation timeline
<p>S-4</p> <ul style="list-style-type: none"> <input type="checkbox"/> Class I - Any specific problems <input type="checkbox"/> Class III <input type="checkbox"/> Fueler status - specific problems <input type="checkbox"/> Class II/IV - Specific problems <input type="checkbox"/> Class V - Critical shortages <input type="checkbox"/> Class VIII - Critical shortages 	<ul style="list-style-type: none"> <input type="checkbox"/> Slant report: <ul style="list-style-type: none"> Current Anticipated at LD Reinforcing unit <input type="checkbox"/> Class IX - Critical shortages <input type="checkbox"/> MSRs <input type="checkbox"/> Host nation support <input type="checkbox"/> Issues

Figure 10-7. Mission Analysis Briefing Checklist.

- Specified, implied, and essential tasks.
- Constraints on the operation.
- Forces available.
- Hazards and their risk.
- Recommended initial CCIR.
- Recommended time lines.
- Recommended restated mission.

Develop the Initial Commander's Intent

During mission analysis, the commander develops his/her intent for the operation. The artillery commander's intent should briefly address the purpose of fires, the desired

endstate, and the methods (essential tasks that must be accomplished, guidance on movements and survivability, etc.) to be used to achieve the endstate. After reviewing the mission analysis briefing and the restated mission, he/she modifies his/her intent statement as necessary.

The commander's intent is a clear, concise statement of what the unit must perform to succeed with respect to the threat, the terrain, and to the desired endstate. It provides the link between the mission and the concept of operations by stating the key tasks that, along with the mission, are the basis for subordinates to exercise initiative when

opportunities arise or when the original concept of operations no longer applies. Intent is normally expressed in four or five sentences and is mandatory for all orders.

The mission and the commander's intent must be understood two echelons down. Key tasks are those one or two tasks the maneuver commander says the artillery must perform or conditions that must be met to achieve the stated purpose of the operation. Key tasks are not tied to a specific COA, but identify what is fundamental to the unit's success. The commander's intent does not include the "method" by which the force will achieve the desired endstate. The method is the concept of operations. If purpose is addressed in the intent statement, it does not restate the "why" (purpose) of the mission statement.

The commander personally prepares his/her intent statement and personally delivers it when possible, along with the order. Commanders from battery level up prepare an intent statement for each OPORD. The intent statement at any level must support the intent of the next higher commander. For any OPORD, there is only one commander's intent. Annexes (including appendixes, tabs, and enclosures) to the OPORD do not contain an intent statement; they contain a concept of support. For example, the Fire Support Appendix (Appendix 19) to an OPORD contains a concept of support, but not an intent statement. The artillery fire plan issued to an artillery battalion supporting a maneuver regiment contains the intent statement of the artillery battalion commander. The intent statement in an OPORD is after operations and before concept of operations.

Issue the Commander's Guidance

The commander's guidance is essential for timely COA development and analysis. By stating the planning options he/she does or does not desire his/her staff to consider, the commander can save staff time and effort by allowing them to concentrate on developing COAs that meet his/her intent.

Commander's guidance may be written or oral, but must focus on the essential tasks conducive to mission accomplishment. The guidance emphasizes in broad terms when, where, and how he/she intends to mass his/her fires to accomplish the mission according to his/her higher headquarters commander's intent. It should include priorities for all combat, CS, and CSSE and how they will support his/her concept. The more detailed the guidance, the more quickly his/her staff can complete the plan, but this increases the risk of overlooking or insufficiently examining things that might affect mission execution. Commander's guidance should include—Specific artillery COA to consider or not consider, both friendly and threat, and the priority for addressing them.

- Prioritized EFATs.
- CCIRs.
- Risk guidance.
- Mobility and countermobility guidance.
- Security measures to be implemented.
- The time plan.
- The type of rehearsal to conduct.
- Munitions mix.
- Reconnaissance guidance.
- Retransmission guidance and survey priorities.
- Any other information the commander wants his/her staff to consider.
- Additional specific priorities for combat support and CSS.
- The type of order to issue.

Issue a Warning Order

Immediately upon the commander providing his/her guidance, his/her staff submits to subordinate and supporting units a warning order that contains, as a minimum—

- Restated mission.
- Prioritized EFATs.
- CCIRs.
- Reconnaissance to be initiated by subordinate units.
- Deception guidance.

- Specific priorities.
- Guidance on rehearsals.
- Commander’s intent.
- Unit’s AO (a sketch, an overlay or some other description).
- Security measures.
- Mobility and countermobility guidance.
- Time plan.

Review Facts and Assumptions

During the rest of the MCPP, the commander and his/her staff periodically review all available facts and assumptions. New facts may alter requirements and analysis of the mission. Assumptions may have become facts or may

have become invalid. Whenever the facts or assumptions change, the commander and his/her staff must assess the impact of these changes on the plan and make necessary adjustments.

Upon completion of mission analysis, the second warning order is issued to subordinate elements See figure 10-8 for the orders process during mission analysis.

The mission analysis activities outlined above produce products that are vital inputs to all subsequent steps in the MCPP. The only required outputs from mission analysis are the artillery commander’s outputs of restated mission, commander’s intent, and commander’s guidance.

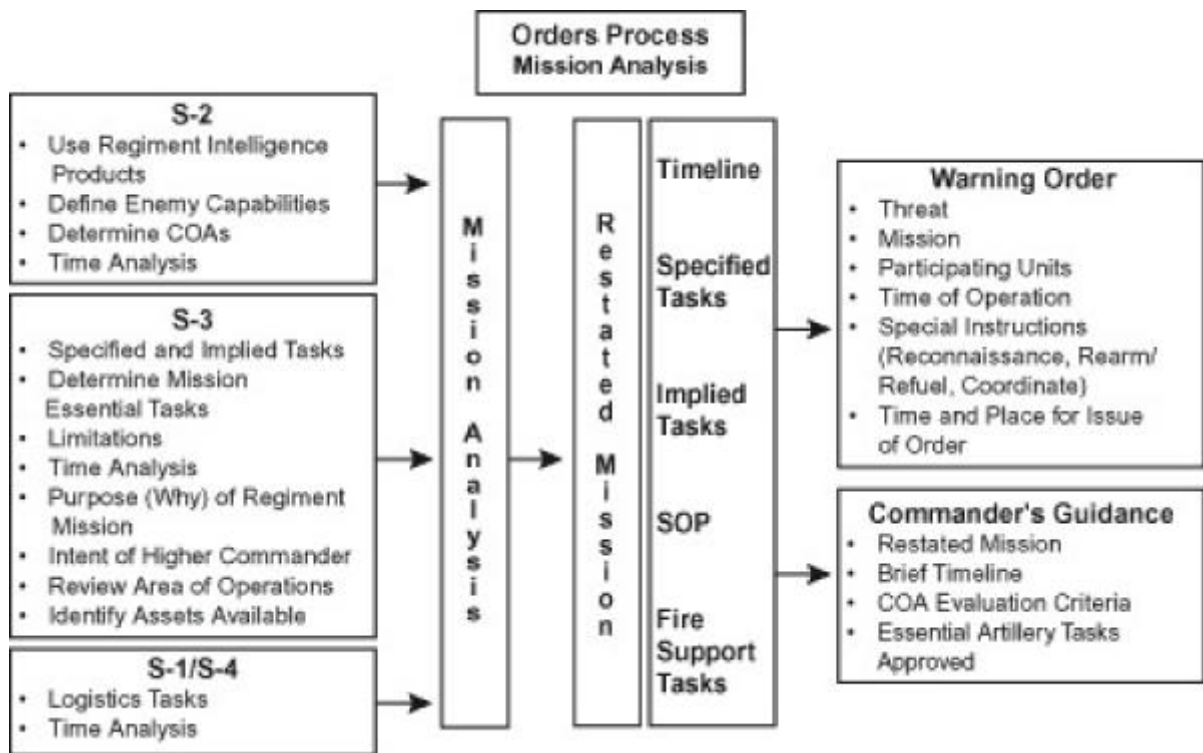

Figure 10-8. Orders Process for Mission Analysis.

Course of Action Development

A COA is a broadly stated, potential solution to an assigned mission. It must be suitable, feasible, acceptable, distinguishable (when multiple COAs are developed) and complete. See figure 10-9. The process of developing a COA is discussed in detail in MCWP 5-1, *Marine Corps Planning Process*.

The outputs from mission analysis (at a minimum include a restated mission, commander’s intent, and commander’s guidance) become the inputs for COA development. A key tool for development of the artillery fire plan is the integration of EFATs and the maneuver commander’s guidance for fire support (provided by the FSC) into the COA development. COA development, like mission analysis, requires the interaction of the entire staff. Members bring their expertise and the information developed during mission analysis to COA development. This information, with the addition of commander’s intent and guidance, is the focal point for development of COAs.

During COA development, planners will use METT-T, threat versus friendly capabilities, and EFATs to determine likely employment options

to support maneuver elements. Planners should consider two fundamental questions—

- What do I do to support maneuver elements?
- How am I going to do it?

Answering the question of “how” is the essence of COA development. The following techniques assist the staff in developing COAs.

Intelligence Preparation of the Battlespace

The S-3 will always start COA development with analyzing the S-2’s modified combined obstacle overlay (MCOO). This overlay will be placed under the maneuver operations graphics. High payoff targets or critical target areas by phase based on the high-payoff target list, maneuver fire support plan, or by templating are plotted. The FDO will provide the quantities of the propellants available. Using the greatest percentage of propellant/shell mix available, the S-3 will determine optimal ranges to target that will dictate range fans used to determine PAs. This information is also given to the FSC so the maneuver commander knows the predominant ranges of his/her fire support assets.

Inputs	Process	Outputs
Artillery mission analysis brief	IPB	Commander’s designation of COAs to be wargamed
Commander’s additional guidance	Array friendly forces	Wargaming guidance
Essential artillery tasks	Assess relative combat power	Evaluation criteria
MCOO	Refined center of gravity	Supporting documents for each COA
Tentative maneuver plan	Develop COA	Staff estimates and additional information
Threat COAs	COA refinements	
Threat center of gravity	COA validation	
Artillery center of gravity	COA graphics and narrative	
Initial staff estimates	Prepare COA briefing	
	Select/modify COAs	
	Develop CO’s wargaming guidance	
	Develop CO’s evaluation guidance	

Figure 10-9. Course of Action Development.

Array Friendly Forces

The intelligence officer will receive a situation template (SITEMP) from the supported unit. This SITEMP will not address all the concerns of the artillery and must be refined to focus on fire support issues. The S-3 will use the SITEMP to deconflict positioning of firing units and supporting units; e.g., radar. PAs are eliminated that are on likely threat avenues of approach, objectives or chemical strike areas. The operations officer considers positioning units that will cause delivery problems for the threat. This may cause the threat to execute high angle missions, which facilitates friendly target acquisition capabilities.

Assess Relative Combat Power

By determining strengths and weaknesses of threat and friendly artillery, the staff can determine what assets are required to accomplish EFATs, what vulnerabilities exist, and how threat artillery can influence friendly operations. The commander seeks to protect his/her weaknesses while exploiting the threat’s vulnerabilities.

Refine Center of Gravity Analysis

Based on EFATs, information determined in the IPB process, and staff estimates, refined centers

of gravity and critical vulnerabilities are used to formulate COAs.

Develop Initial Courses of Action

Artillery COAs should be developed for each maneuver COA. These artillery COAs should be based on the EFATs derived from the EFSTs of the maneuver order. If a COA does not accomplish these tasks, then the COA is not suitable for further consideration. Within COA development, the operations officer should also consider FSCMs, radar zones, retransmission sites or any other measures that will influence support to maneuver elements.

Course of Action Graphic and Narrative

For each COA, graphics are created to portray how the organization will accomplish the mission. This includes FSCMs, PAs, range fans, EFATs, and radar coverage. See figure 10-10.

Course of Action Criteria

Before briefing the COAs, the following questions should be asked is the COA—

- Suitable?
- Feasible?
- Acceptable?
- Distinguishable?
- Complete?

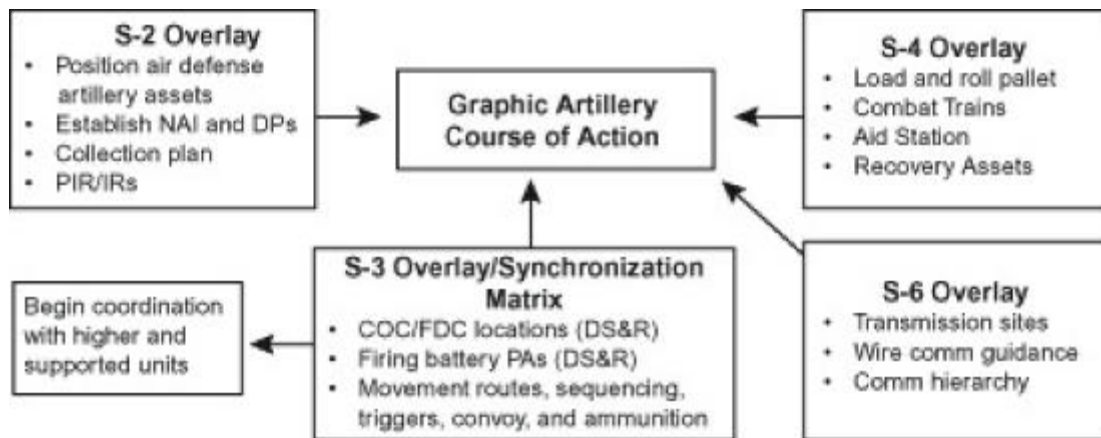

Figure 10-10. Artillery Scheme of Maneuver.

Prepare Course of Action Briefing

Once COAs are developed, they are briefed to the artillery commander to confirm that his/her guidance has been met. The briefing may include—

- Updated IPB.
- Possible threat COAs focusing on artillery.
- Restated mission of the artillery commander.
- Maneuver commander's intent for fire support.
- COA statement and graphic.
- Rationale for COA.
- Considerations that may affect threat COAs.
- Deductions resulting from a relative combat power analysis.
- Reasons units are arrayed on the graphic.
- Reason for selected control measures.
- Updated facts and assumptions.

Select/Modify Courses of Action

Commander Determines Courses of Action to be Wargamed

The commander may give further guidance on evaluation criteria that will focus the wargaming effort and data collection efforts of the staff. COA development activities produce outputs that drive subsequent steps of MCPP. Required outputs of COA development follow.

Courses of Action Designated by the Commander to be Wargamed

Once the staff briefs the commander on the COA, the commander will determine if they meet his/her guidance and choose which ones, if any, that will be wargamed further.

Commander's Wargaming Guidance

The commander may decide to give further guidance on the direction the staff will take the wargaming. This is based upon additional guidance received from higher or supported unit or his/her own judgment.

Evaluation Criteria

Before evaluating the COA, the end state must be understood to determine which COA best supports the commander's guidance and scheme of maneuver.

Supporting Documents for Each Course of Action

Each COA should contain graphics and overlays.

Staff Estimates and Additional Information

Special staff officers will help the primary staff by analyzing the COAs based upon their areas of expertise, indicating how they can best support the operation. Every member of the staff must determine force requirements for external support, risks involved, and each COA's strength and weakness.

Course of Action Wargaming

Wargaming is a detailed analysis of the COAs prepared by the staff. It is an attempt to visualize the flow of a battle. The process considers friendly dispositions, strengths, and weaknesses; threat assets and probable COAs (likely and most dangerous); and characteristics of the AO. It focuses the staff's attention on each phase of the operation in a logical sequence. Wargaming is the most valuable step during the orders process and should be allocated the most time. During this period the commander and staff may change an existing COA or develop a new COA after identifying unforeseen critical events, tasks, requirements, or problems. While wargaming COAs —

- Remain objective.
- Accurately record advantages and disadvantages.
- Continually assess feasibility, acceptability, and suitability.
- Avoid premature conclusions.
- Avoid COA comparison.

From COA development outputs, the staff takes important information to begin the wargaming process. Information includes the COA chosen by the commander to be war gamed, any additional guidance the commander may have for wargaming, and estimates and requirements that the staff has to support the COAs. See figure 10-11. Responsibilities of the staff during wargaming are shown in figure 10-12 on page 10-16. The wargaming methodology follows a 10-step process.

Step 1: Consider the Commander’s Wargaming Guidance and Evaluation Criteria

The commander will assess the time available at the conclusion of COA development. The degree to which a COA achieves the EFATs allows the commander to decide which COA is optimal based on time, space, and resources available. His/Her evaluation criteria will address specific issues/questions that the commander wants his/her staff to determine during the conduct of the war game, however the focus will be to determine if the EFATs can be realistically accomplished by the COA. The commander should take into account the options and capabilities of the threat commander and yet be

mindful of his/her own vulnerabilities when devel-oping his/her war gaming guidance.

Step 2: Gather the Tools

At the beginning of war gaming, the staff should have the following information available:

- Approved mission statement.
- Commander’s intent and planning guidance.
- Maneuver commander’s intent for fires and scheme of maneuver.
- Assumptions.
- Constraints and restraints, including ammunition available and communication ranges.
- CCIRs.
- Maps covering the entire AO.
- Friendly force list.
- Threat order of battle.
- MCOO with weather and terrain analysis and probable PAs.
- Current and projected threat situation overlays.
- Current and projected friendly situation overlays.
- Threat SITEMP for each COA.
- Threat event template.

Inputs	Process	Outputs
Commander’s designation of COAs to be wargamed Wargaming guidance Supporting documents for each COA Staff estimates and additional requirements	Consider commander’s guidance Gather tools List friendly forces List assumptions List known critical events and decision points Select wargame method Select method to record and display results Conduct wargame Refine staff estimates and contributions Prepare COA wargame brief	Wargamed COA with graphics List of critical events and decision points Wargame products

Figure 10-11. Course of Action Wargaming.

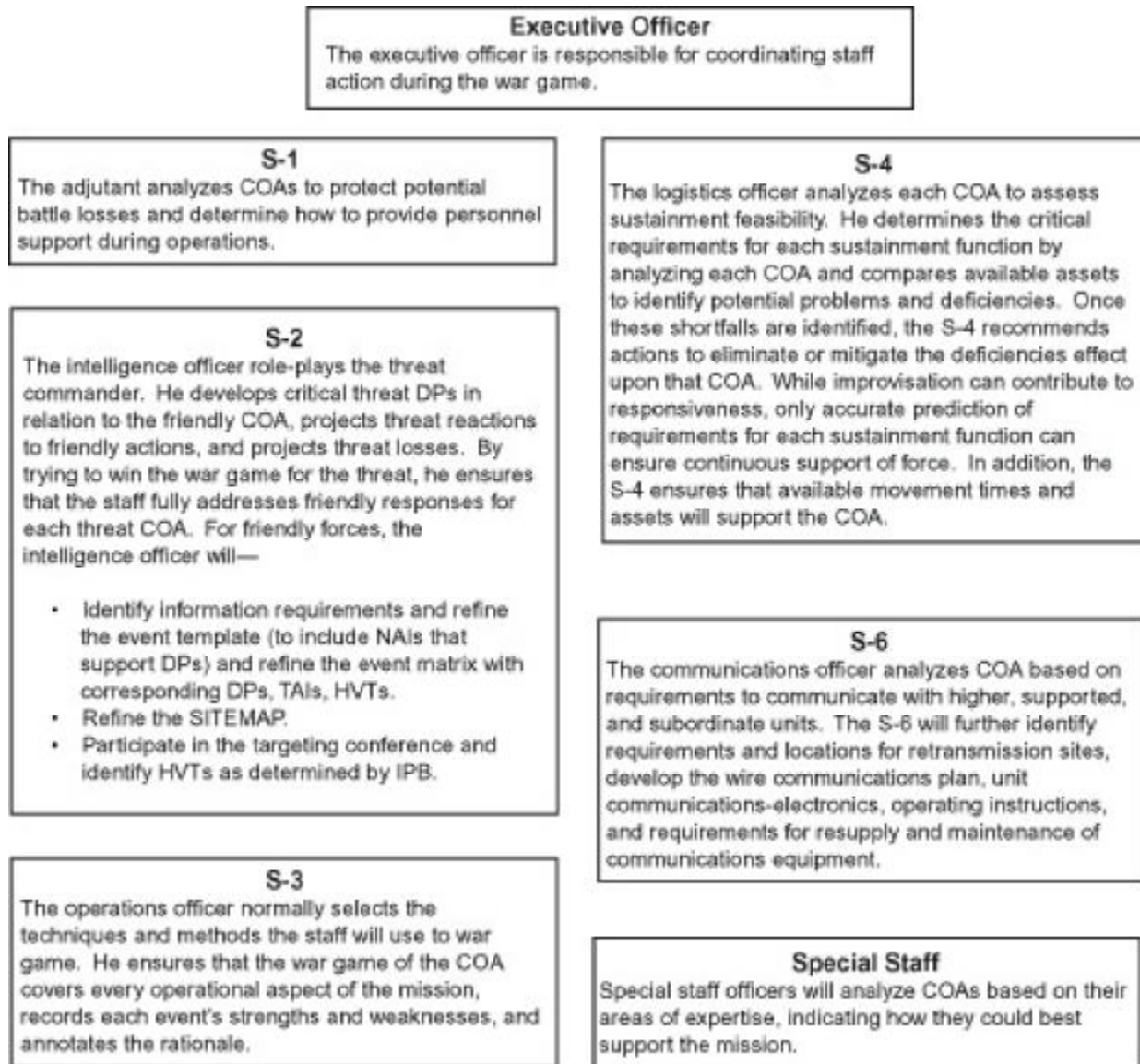

Figure 10-12. Wargaming Responsibilities.

In addition, the staff should have the following information from COA development:

- Assessment of relative combat power. Specifically, the threat's indirect fire support assets and counterfire ability.
- COAs.
- Graphics and narratives.
- Decision support matrix/template.
- War game rules.
- Recording tools (synchronization and COA development matrices).

Step 3: List Friendly Force List

List all friendly forces arrayed on the battlefield.

Step 4: List Assumptions

The staff reviews previous assumptions to determine if they are still valid or have changed. The staff will have to brief the commander how these assumptions influenced the outcome of the war game.

Step 5: List and Graphically Display Known Critical Events and Decision Points

From the IPB products developed during mission analysis, a decision support template is used to relate the event template with decision points that are significant to the artillery unit.

The event template overlays the operations graphics to depict time phase lines (TPLs) on the battlefield. The operations officer will list EFATs, which may include massing missions, special munitions missions, unit movement, survey emplacement, etc. The decision support template (DST) does not dictate decisions to the operations officer but identifies critical events and threat activities relative to time and location that may require tactical decisions.

Step 6: Select the War Game Method

The four methods used are sequence of essential tasks, avenue in depth, belt, and box. See MCWP 5-1 for a detailed discussion of each technique.

Step 7: Select Method to Record and Display Results

One method for recording the results is the synchronization matrix (see figure 10-13 on page 10-18). It allows the staff to synchronize the COA across time and space in relation to the threat COA. An advantage of this method is that it can be readily translated into a graphic decision-making product. The first entry is time or phase of the operation. The second entry is the most likely threat action as determined by the S-2. The third entry is the DP for the friendly COA. The remainder of the matrix is developed around selected functional areas or major subordinate commands.

Step 8: Wargame the Battle

Wargame each EFAT. The intelligence officer will discuss the timing of the battle off the TPL, the operations officer addresses EFSTs, and the FDO briefs mission execution times (time of flight ([TOF], shift times, first round to last).

Wargame the fire plans to make sure they are executable. The S-2 describes what the threat is doing and their rate of march. The S-3 adds the type of target, artillery impact area (front, rear, center of formation), and the number of rounds and volleys required. The FDO then states whether or not units are laid on the target, who will fire, shift time required, TOF, and total time. It is critical to use honest times based on the unit's level of experience and not just standard Marine Corps Combat Readiness Evaluation System times. Using this information and the TPL, place a decision point (star) on the operations graphics that represents the final time that the artillery can attain its greatest effects upon the threat located at that point. Decision points in the forward battle area may not be observable by organic assets. These decision points should correspond to a trigger point of the supported unit who is watching the decision point. As the S-2 identifies threat forces at or near decision points, the S-3/FDO is alerted and expects calls for fire for the target tied to the decision point.

Use the DST to determine decision points for other critical events such as unit movements, special munitions missions, radar queuing times, logistics operations, etc.

Step 9: Refine Staff Estimates and Contributions

Once the war game is complete and the results annotated, the staff refines their estimates and contributions. Examples of contributions are listed in figure 10-14 on page 10-19.

Critical Event or Time				
Friendly Action				
Threat Reaction				
Friendly Counteraction				
Decision Point				
Intelligence	NAI			
	TAI			
	Collect			
Artillery Operations	Move			
	Priority of Fires			
	Priority Target			
	Survey			
	Radar			
	Met			
	Subordinate Tasks and Purpose			
Support Operations	Mobility, Countermobility, Survivability,			
	NBC			
	CSS			
	C2			
	Risk			
	External Coordination			
	Notes			

Figure 10-13. Sample COA Synchronization Matrix.

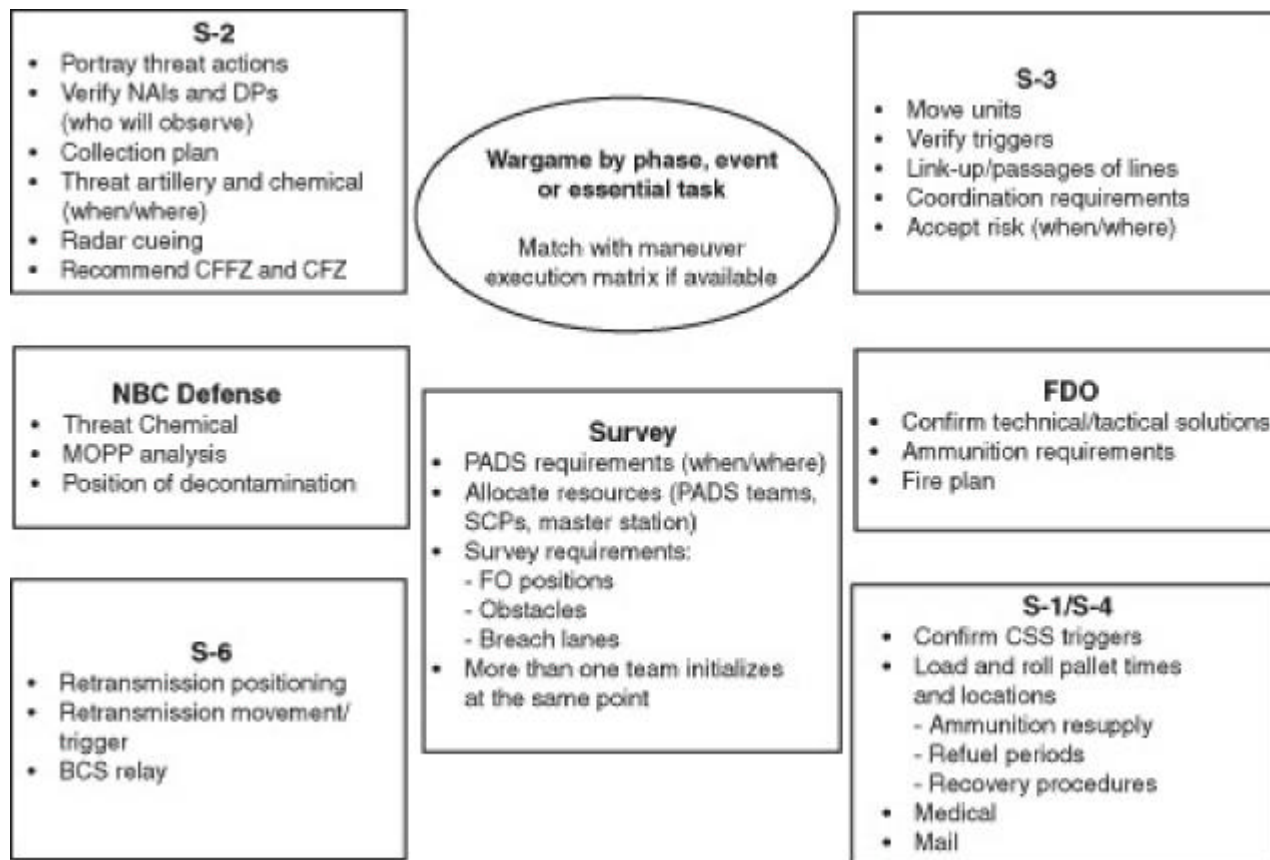

Figure 10-14. Staff Contributions to Wargaming.

Step 10: Prepare Course of Action War Game Brief

Upon completion of the COA wargaming, the staff briefs the commander on the advantages and disadvantages of the COA and any suggested modifications.

Once wargaming is complete and the staff briefs the commander on the results, the staff then takes, at a minimum, the wargamed COA and graphics, list of critical events and decision points, and information on the commander’s evaluation criteria to be used in follow-on steps.

Course of Action Comparison and Decision

Once wargaming is complete, each of the war gamed COAs are compared against each other to

determine which COA will be chosen to execute. The staff will use the COA graphics, critical events and decision points, the commander’s evaluation criteria, and other information, such as staff estimates, to aid them in determining the best course of action to choose. See figure 10-15 on page 10-20.

Course of Action Evaluation

During this phase, each COA is evaluated against the commander’s evaluation criteria. Advantages and disadvantages are discussed and recorded. See figure 10-16 on page 10-20. This sample matrix can assist the staff in making their recommendations for a particular COA.

Course of Action Comparison

The staff ranks each COA with respect to advantages and disadvantages in addition to evaluation

Inputs	Process	Outputs
Wargamed COA List of critical events and decision points Information on commander's evaluation criteria	COA evaluation COA comparison Commander's decision Prepare the concept of artillery support Issue the warning order	Concept of operations Refined commander's intent High pay-off target list Specified type of rehearsal Specified type of order

Figure 10-15. Course of Action Comparison and Decision.

COA Comparison			
	COA 1	COA 2	COA 3
Advantages	RISK—Least risk	COUNTERFIRE— Simplicity	MISSION/TASKS—Best means of accomplishing essential artillery tasks
Disadvantages	FIRES—Essential artillery tasks difficult to accomplish	C2—Difficult to control due to mobile plan	RISK—accepts most risk

Figure 10-16. Advantages and Disadvantages Matrix.

criteria such as mission accomplishment, EFATs, and battlespace functions. These ranks are totaled and compared. This comparison gives the commander the information that he/she needs to make a sound decision. However, these rankings may be more subjective than objective numbers indicate. The commander and staff must examine the matrix for sensitivity. For example, one course of action may be determined to be the “best,” however, it may not be supportable by one of the battlespace functions (logistically, communications, etc.). The commander must take this into account and determine if additional support is required or the COA must be adjusted or thrown out. See figure 10-17.

Commander's Decision

The staff compiles the information from the comparison matrices and then briefs the commander. Upon selecting a COA, the commander reviews the COA to determine if it must be modified or combined with elements of different COA to mitigate disadvantages. He/

She reviews the mission statement and may refine his/her commander's guidance. He/She then issues any additional guidance on priorities for CSS (particularly for resources he/she needs to preserve his/her freedom of action and to ensure continuous service support).

Prepare Concept of Artillery Support

The staff prepares the framework for the orders process. The concept of artillery support is a general description of how the artillery will support maneuver forces and a generic organization for combat. The concept of artillery support normally includes graphics and a narrative.

Issue the Warning Order

Once the concept of artillery support is complete, the commander will issue a warning order to allow his/her subordinate commanders to perform concurrent planning.

Once a course of action is chosen and the concept of artillery support is completed, the staff will

Criteria	COA 1	COA 2	COA 3
Intelligence	3	2	1
Force protection	2	1	3
Maneuver	2	1	3
Decisive action	3	2	1
Simplicity	3	2	1
Movement—number and length	2	3	1
Mission/fires—accomplish essential field artillery tasks	3	2	1
Counterfire	1	3	2
C2—retransmission critical	2	3	1
CSS supportability	3	2	1
Other	2	1	3
TOTAL	26	22	18

Figure 10-17. Comparison Matrix.

turn to completing the orders process using this concept of artillery support, a refined commander’s intent, high pay-off target list, and additional information such as: updated IPB, decision support tools, updated CCIRs, staff estimates, synchronization matrix, and the warning order. The commander will also determine the type of order written and his/her timeline for rehearsals.

Orders Development

Based on the commander’s decision and final guidance, the staff refines the COA and

completes the plan and prepares to issue the artillery fire plan. The COA statement and graphics become the basis for the concept of artillery support and the operations overlay. The concept of artillery support is the commander’s clear concise statement of where, when, and how he/she intends to concentrate combat power to accomplish the EFATs from the supported units’ fire support plan. Orders and plans must provide all necessary information subordinates require for execution, but without unnecessary constraints that would inhibit subordinate initiative. Before issuing the order, the commander reviews it to ensure it meets his/her commander’s intent. See figure 10-18.

Inputs	Process	Outputs
Initial task organization Mission statement Commander’s intent Concept of artillery support Tasks	Preparation of order or plan based on: Concept of artillery support Staff estimates and other planning documents Orders reconciliation Orders crosswalk Commander approves plan	The order or plan Synchronization matrix Decision support tools Updated intelligence and IPB products

Figure 10-18. Orders Development.

The XO coordinates the staff to assist the operations officer in developing the order. The XO will dictate, from guidance of the CO, the format of the order, set and enforce timelines, and determine which enclosures will be published and by which staff section. See figure 10-19 for an example format of the artillery fire plan brief.

Preparation of the Order or Plan

Situation

Expands upon higher or supported unit OPORD/fire support appendix situation. Focus on fire support issues and assets.

<p>S-3: Map Orientation</p> <p>S-2: Intelligence Estimate</p> <p>Terrain Analysis</p> <ul style="list-style-type: none"> • MCOO • KOCSA <p>Weather Analysis</p> <ul style="list-style-type: none"> • Forecast • Light Data/Night Vision Goggle Windows • Effects on Friendly/Threat <p>Threat Evaluation</p> <ul style="list-style-type: none"> • Enemy Order of Battle <ul style="list-style-type: none"> – Maneuver Forces – Artillery • Threat Most Likely COA • Threat Most Dangerous COA • Threat Timelines • Artillery Range Fans • CCIR <p>S-3: Friendly Situation</p> <ul style="list-style-type: none"> • Higher Commander's Mission • Higher Commander's Intent • Higher Commander's COAs • Priority of Fires <p>S-3: Unit's Mission</p> <p>S-3, S-2, FDO</p> <ul style="list-style-type: none"> • Tasks to Subordinate Units <ul style="list-style-type: none"> – Smoke Missions and Alternate – FASCAM Missions and Alternate – Copperhead Missions and Alternate – Counterfire Plan – Reinforcing Unit • Movement Plan and Triggers <ul style="list-style-type: none"> – Position Areas – Reinforcing Unit's Position Areas <p>FDO: Scheme of Fires/Target Responsibilities</p> <ul style="list-style-type: none"> • Fire Order Standards • Ammunition Requirements • Met Status • Digital Device Status 	<p>Survey Officer: Survey Plan</p> <ul style="list-style-type: none"> • Priorities • Link Up Points • Hand Off Instructions • Frequencies • Simulated Station Location <p>NBC Defense Officer: NBC Defense Plan</p> <ul style="list-style-type: none"> • MOPP Level • Anticipated Threat Use • Decontamination Sites and Priorities <p>S-2: Target Acquisition</p> <ul style="list-style-type: none"> • Radar Location • Movement Plan and Triggers • Radar Zones <p>S-4: Concept of Logistics Report</p> <ul style="list-style-type: none"> • Location of Combat and Field Trains • Ration Cycle • Anticipated Replacement Flow • Special Considerations <p>Surgeon</p> <ul style="list-style-type: none"> • Aid Station Locations <p>S-4: Ammunition Plan</p> <ul style="list-style-type: none"> • Resupply Triggers <p>S-6: Communications Plan</p> <ul style="list-style-type: none"> • COC Location • COC Movement Plan and Triggers • Retransmission Locations • Retransmission Priorities and Procedures <p>S-3: Significant Coordinating Instructions</p> <ul style="list-style-type: none"> • Directed Rehearsal/Status <p>S-3: Review Timeline</p> <ul style="list-style-type: none"> • Rehearsal Time and Location • Time Synchronization <p>Commander: Guidance and Remarks</p>
--	---

Figure 10-19. Example Format of the Artillery Fire Plan Brief.

- **Threat forces:** Address the number, type, and capabilities of the threat fire support assets to include expected number of air sorties. Describe any ground or air threats to subordinate units. Identify the threat center of gravity or critical vulnerabilities.
- **Friendly forces:** Contains the missions of higher artillery HQ or supported maneuver unit. Missions of adjacent and supporting are also included. State the maneuver commander's intent for fires if DS or the higher artillery commander's intent if GS or GS/R.
- **Attachments and Detachments:** If any, describe when and how long this is effective and for whom.
- **Assumptions:** List any additional assumptions not in higher or supported orders.

Mission

The mission statement is a concise statement of what the artillery is to accomplish. If there are any reinforcing units, include them in the mission statement.

Execution

- **Commander's Intent:** This is where the artillery commander briefly describes EFATs, what he/she sees as the friendly and threat center of gravity, and his/her desired end state with respect to the relationship among the force as a whole, the threat, and terrain.
- **Concept of artillery support:** This is the commander's visualization of artillery support for the operation, by phase or EFAT, to the desired end state. It is written in sufficient detail to enable appropriate action by subordinate units in the absence of more specific instructions. This paragraph should tie in the concept of fires with the supported unit's scheme of maneuver.
- **Organization for combat:** This is a clear statement of organization for combat and tactical missions assigned to subordinate units. "On order" and "be prepared to" missions are included in this paragraph.

- **Tasks to subordinate units:** These instructions detail specific tasks assigned to batteries, including specific EFATs. Tasks should be assigned by battery, reinforcing unit or phase.
- **Coordinating instructions:** As the last paragraph of the "execution" paragraph, it includes instructions and details that pertain to two or more subordinate elements. Some of these instructions may be developed into enclosures to the artillery fire plan. This sub-paragraph may address the following:
 - Target acquisition.
 - Liaison requirements.
 - Survey.
 - Schedules/programs of fire.
 - Automated fire control.
 - PIR.
 - High-payoff target list.
 - Ammunition restrictions.
 - Attack guidance matrix.
 - Antifratricide measures.
 - NBC defense/MOPP level.
 - Checkpoints.
 - Met.
 - Rehearsal times.

Administration

Times, location, and format of personnel accountability and strength reports are detailed.

Logistics

This paragraph describes how the artillery unit will logistically support itself in the accomplishment of the mission. Ammunition resupply, maintenance procedures, location of field and combat trains, deployment of the unit's aid station. Procedures to request logistics support is described.

This subparagraph lists the locations of unit CPs/COCs, location of the commander, and succession of both fire direction responsibility and command.

Signal

Includes the updated communications-electronics operating instruction, wire plan, special signal instructions, retransmission locations and priority, and digital subscriber tables. This section will also describe specified uses of pyrotechnics for signaling and the challenge and password.

Orders Reconciliation

This internal process used by the staff ensures that the basic order and all enclosures are complete and in agreement. It identifies discrepancies or gaps that the staff must correct. In particular, the staff compares the commander’s intent, mission, and CCIRs against the concept of artillery support and supporting concepts.

Orders Crosswalk

The staff compares the order with the orders of higher, adjacent, and supported commanders. This helps achieve unity of effort and ensure that the higher commander’s intent is met.

Commander’s Approval of Order or Plan

The final action taken is the approval of the order by the commander. The actual output of this process is the operations order or plan that will be executed. Along with the order is all the supporting documentation such as overlays, matrices, and enclosures.

Transition

Transition ensures the successful shift from planning to execution. It is meant to enhance the situational awareness of those who will execute the order, maintains the intent of the concept of artillery support, promotes unity of effort, and generates tempo. Transition is a continual process that requires a free flow of information between the commander, staff, and subordinate elements by all means available. The basis for the transition is the approved operations order or plan, along with products of continuing staff action such as updated IPB or synchronization matrices. See figure 10-20.

Orders Brief

The transition begins with issuing the order (written, matrix or verbal, depending on time available) to subordinate commanders.

Rehearsals

Confirmation Brief

Routinely performed by subordinate commanders immediately after receiving any instructions, such as OPORD, fragmentary order, etc. Subordinate commanders brief the higher commander on their understanding of the commander’s intent, their specific tasks and purpose, and intra-relationship of all units in the plan.

Inputs	Process	Outputs
The order or plan Synchronization matrix Decision support tools Updated intelligence and IPB products Information on future operations Any outstanding issues	Orders brief Rehearsals	Subordinate commanders: <ul style="list-style-type: none"> • Ready to execute • Prepared for future operations

Figure 10-20. Transition.

Back Brief

The back brief is normally conducted throughout the planning process. This rehearsal allows the commander to clarify his/her intent early in the subordinates' planning process, identify problems in the concept of artillery support, and understand how subordinates plan on accomplishing the mission.

Combined Arms Rehearsals

This rehearsal is normally conducted by the maneuver unit's headquarters after subordinate units have issued their OPORDs. It ensures that maneuver and fire support units are synchronized to achieve the mission and intent of the higher commander.

Support Rehearsals

Separate battlespace functions will conduct rehearsals throughout the planning process. Examples of these rehearsals are the communications or fire support rehearsal.

Battle Drill or Standing Operating Procedure Rehearsal

A battle drill or SOP rehearsal ensures that all participants understand a technique or a specific set of procedures.

By issuing the order and conducting rehearsals, the commander can feel a measure of assurance that his/her subordinates are ready to execute the plan and are prepared for future operations.

SECTION III. ARTILLERY AND THE INTELLIGENCE PREPARATION OF THE BATTLESPACE PROCESS

General

The artillery S-2 should receive initial IPB products from the supported or higher unit's G-2/S-2. This IPB should expand and focus toward the mobility and survivability of the artillery unit. IPB is the process of understanding the battlespace, the threat, and options available. It consists of an analysis of the terrain, weather, threat doctrine, and threat actions. The purpose is to aid in the early determination of the threat's most probable course of action.

IPB is a systematic and continuous process of analyzing the threat, weather, and terrain. The IPB process integrates threat doctrine with weather and terrain to determine how the weather and terrain will influence the threat's fight. The IPB process consists of four functions:

- Define the battlespace.
- Determine battlespace effects—terrain and weather.

- Evaluate the threat—threat evaluation.
- Determine threat COAs—threat integration.

The MCOO is an in-depth study of the battlespace incorporating terrain and weather. The MCOO graphically depicts the first two components of the IPB process (battlespace evaluation, terrain and weather analysis) on one overlay that can be initiated prior to combat and then refined once deployed to the AO. Before beginning the MCOO, the S-2 must establish the criteria for the MCOO. The criteria on which the artillery S-2 must focus are those that affect the use of artillery and fire support, such as—

- Site to crest.
- Intervening crests.
- Howitzer cant.
- Range to target.
- Soil composition.
- Intervisibility lines.
- Mobility corridors.
- Avenues of approach.

Pre-Battle Preparation

The S-2 must focus on studying the doctrine of the likely threats his/her unit will face in battle, then building order of battle (OOB) databases on those units. The S-2 has many resources available to build his/her threat data base and obtain an understanding of how the threat fights. The artillery S-2's OOB studies must focus on threat maneuver force doctrine; threat artillery doctrine and capabilities; and threat air defense artillery doctrine.

Threat Maneuver Force Doctrine

- Numbers of vehicles and weapons by type (light versus heavy).
- Formations used.
- Movement rates: day, night, security zone, MBA, prebattle, battle, etc.

Threat Artillery Doctrine and Capabilities

- Weapon types.
- Number of tubes per battalion.
- Capabilities of each system: ammunition mix, ranges, rates of fire.
- Dispositions: deployment distances between firing units in relation to maneuver missions of each echelon, location and amount of any specific artillery groupings.
- Counterfire capability and response time.
- EW threat to friendly counterfire radars: detection capability, jamming capability.
- Types of fire by maneuver phase: What type of indirect fires will the threat conduct during each maneuver phase of the battle.

Threat Air Defense Artillery Doctrine

- Numbers by echelon.
- Disposition: deployment on the battlefield.
- Capabilities.
- Air phases of support.

These are the minimum information requirements. The S-2 must continuously research potential threat forces to build, maintain, and refine threat OOB database.

Terrain

From the artillery perspective, the S-2 identifies severely restricted, restricted, and unrestricted terrain. He/She marks severely restricted terrain on an overlay with crosshatch marks and restricted terrain with single-hatch marks. Artillery units must identify terrain that affects firing as well as mobility. Severely restricted terrain for artillery causes extreme difficulty for weapon emplacement and firing. Restricted terrain hinders emplacement and firing to a lesser degree and probably requires a detailed reconnaissance effort to locate suitable positions. During the orders brief, the S-2 addresses possible problem areas if artillery must occupy questionable PAs. To determine severely restricted, restricted, and unrestricted areas, the artillery S-2 analyzes the following factors.

Elevations

Identify the elevations in the battlespace that may cause problems for firing units. The fire direction officer can assist the S-2 in determining these problem areas. The S-2 must discuss with the FDO, given positioning of firing units in relation to terrain, what elevations will cause site-to-crest, intervening crest, and vertical interval problems. PAs that will reduce XO's minimum quadrant evaluation problems should be identified, thus eliminating the need to recompute fire missions for high angle due to site-to-crest problems.

Slope

Possible slopes in the battlespace that may cause cant problems for firing units should be identified.

Approximately 5 degrees (90 mils) is the maximum allowable cant for all series howitzers and MLRS launchers. Terrain that causes a cant of 90 mils or more is severely restricted for artillery.

The most reliable information on slope is reconnaissance; however, topographical maps are also important sources. To determine the slope of an area from a map, divide the contour interval by the horizontal distance between the contour lines and multiply by 100. The purpose is not for the S-2 to conduct a time-intensive map study to determine the slope for all possible PAs; rather, the S-2 can use this analysis to identify areas where units may encounter cant problems. Once identified, these areas are classified as restricted until verified by actual ground reconnaissance. With this information, the S-2 can assist the S-3 in directing firing batteries to conduct reconnaissance of areas with possible cant problems.

On the "Source" compact disk is a Terrabase program. This program can be used to study terrain of an area by simply inputting a grid to a possible PA; it will allow the operator to traverse 6400 mils to analyze the terrain.

Soil Composition

Identify areas of possible poor soil composition that may cause problems for towed howitzers. For example, very rocky, sandy or boggy areas may cause mobility, emplacement or displacement problems. There is often information about soils (or evidence to their characteristics) on maps and in reports concerning climate and geography. For instance, orchards are usually planted in well-drained, sandy soils; agricultural fields in low areas become wet and boggy during periods of rain.

As with slope determination, ground reconnaissance is the best and only method to verify the actual suitability of areas to support howitzers.

However, the S-2 can assist the S-3 by identifying areas with soil composition that may require reconnaissance prior to occupation. Once these areas are identified, they are classified as restricted until verified by actual ground reconnaissance.

Mobility Problems

Areas that will cause mobility problems for artillery and channelize threat movements should be highlighted. The higher maneuver headquarters' IPB product will probably already have identified most of the terrain that is severely restricted and restricted for mobility. See figure 10-21 on page 10-28.

Intervisibility Lines

On the same overlay, areas that deny visibility between opposing forces are graphically depicted by drawing intervisibility lines where the terrain dictates. An intervisibility line is an area on the battlefield beyond which opposing forces cannot observe. Examples are ridge lines, wadi systems, fingers or forested areas. Intervisibility lines will become particularly important in identifying PAs that are hidden from threat avenues of approach. Aerial and satellite imagery, if available, are useful to the S-2 in further analyzing the terrain. See figure 10-22 on page 10-28.

Avenues of Approach

Using standard symbols graphically depicts the ground and air avenues of approach on the MCOO. During construction of these avenues of approach, the artillery S-2 refines the higher headquarters' IPB products to depict regiment and battalion sized avenues of approach that can affect artillery movement and positioning plans.

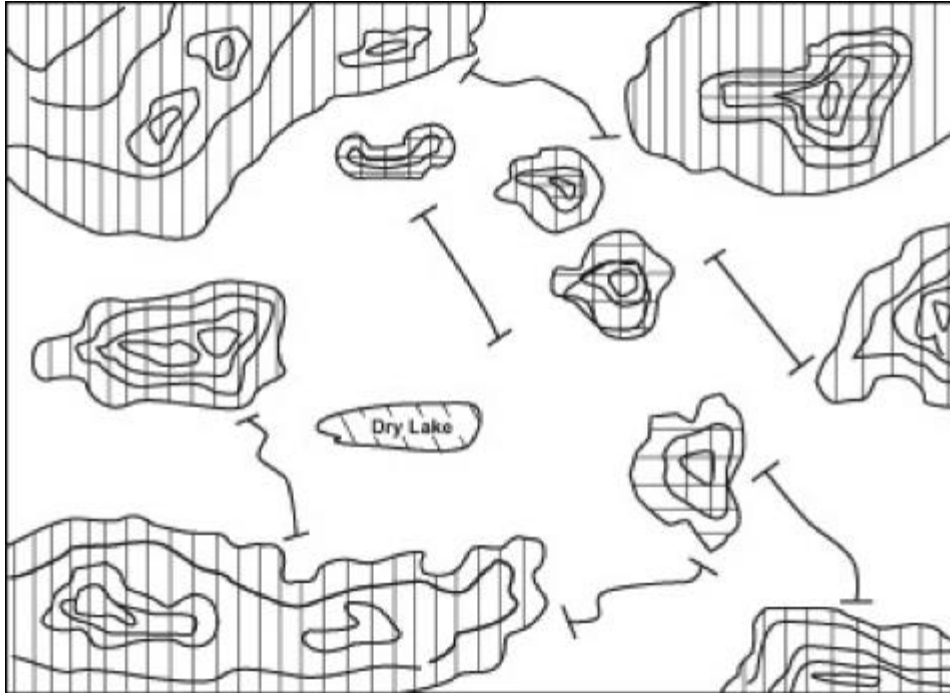

Figure 10-21. Modified Combined Obstacle Overlay with Restricted and Severely Restricted Terrain Marked.

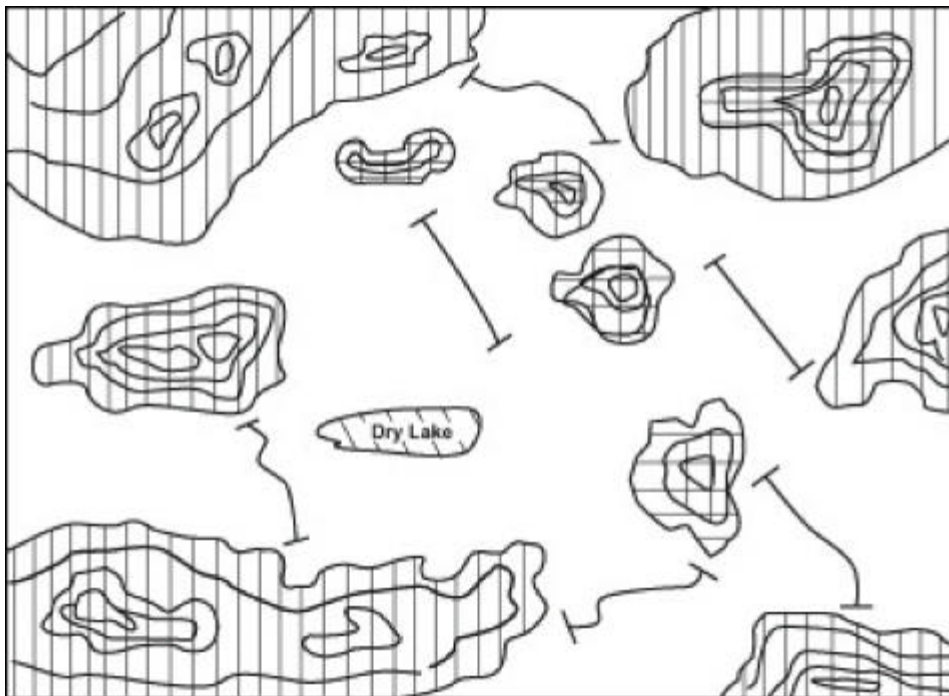

Figure 10-22. Modified Combined Obstacle Overlay with Intervisibility Lines Identified.

The S-2 begins by depicting all threat mobility corridors of platoon size and above that can affect the artillery's AO. The S-2 focuses his/her effort down to threat platoon level because of the danger a threat platoon poses to artillery units. One tank passing through or near an artillery PA can easily destroy a firing battery. If the MCOO becomes too busy and unreadable because of too many platoon-sized mobility corridors, then go one level higher. Lastly, the mobility corridors are combined into their appropriate battalion and regiment avenues of approach. During this process, the S-2 must depict the avenues of approach through the artillery's battlespace.

During COA development, the S-3 selects possible PAs away from the threat mobility corridors and avenues of approach. If the situation dictates that the S-3 must position some units on these threat air or ground avenues of approach, then the S-2 must ensure he/she briefs the affected battery

commanders on the threat they may face. This provides the battery commander with critical information he/she uses during his/her own planning. See figure 10-23.

Key and Decisive Terrain

On the same MCOO overlay, key terrain is marked with a "K" in a circle. Exactly what constitutes key terrain is situationally-dependent. During COA development, the S-3 will avoid positioning batteries in these areas because this is where the close in fight will likely take place.

Position Areas

The S-2 evaluates the battlespace and templates all possible battery-size PAs given the considerations

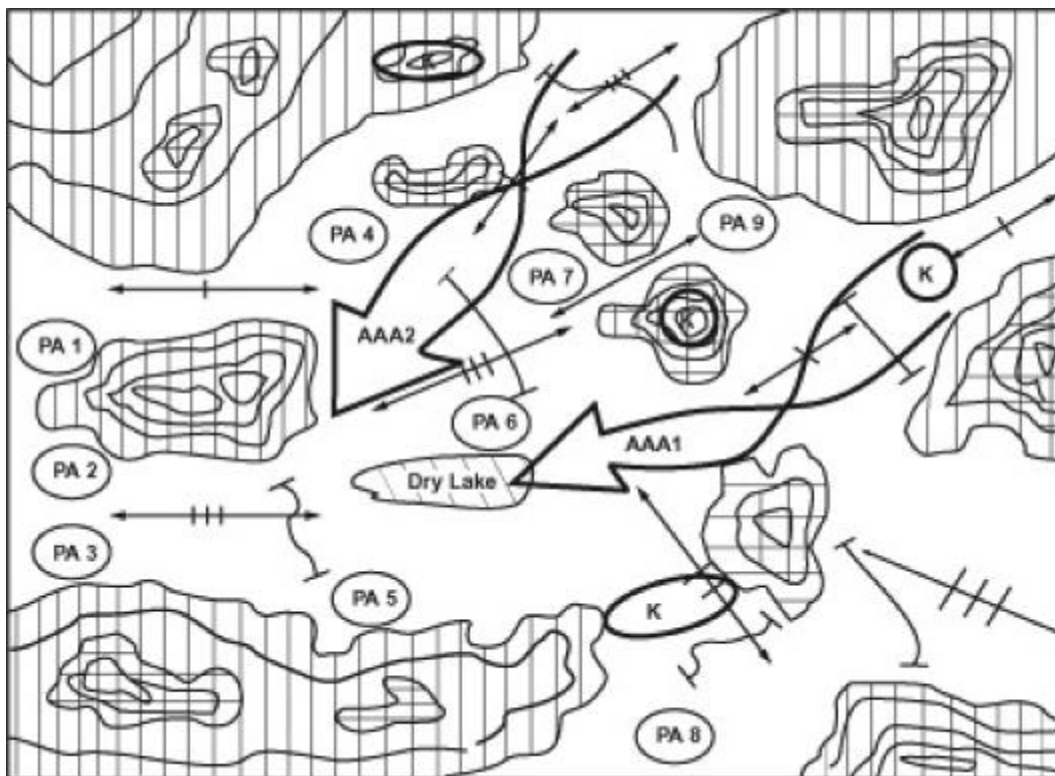

Figure 10-23. Modified Combined Obstacle Overlay Depicting Mobility Corridors, Avenues of Approach, Key Terrain, and Possible Position Areas.

identified in the preceding paragraphs. All PAs are templated for use during current and future operations. The S-2 can then provide a product to the S-3 that can greatly assist him/her in choosing appropriate battery PAs during COA development. This works well during operations when the staff has limited planning time.

This process helps to avoid the S-3 conducting his/her limited terrain analysis and drawing battery “goose eggs” on the operations overlay without reference to the elements the S-2 considers. Without a process such as this, S-3s tend to choose PAs based only on considerations of range and threat avenues of approach.

The Modified Combined Obstacle Overlay and Course of Action Development

The S-2’s MCOO allows the S-3 to quickly focus on the best terrain for battery positions. The S-2 must ensure the MCOO is readily available to the S-3 so he/she can begin COA development through analyzing the MCOO.

The process of choosing battery PAs begins with the S-3 hanging the MCOO on the operations map and placing the operations overlay over it. Then, based on the maneuver FSC’s guidance, the S-3 determines critical targets, by phase. Based on available ammunition, the S-3 and FDO determine the predominant gun-target planning range under standard conditions. This information, passed through the FSC, also provides the maneuver commander with an accurate planning range for his/her direct support artillery.

Once a correct planning range is determined, the S-3 draws a range fan starting from the critical target area *backwards* to the proposed PAs. All PAs on the MCOO that are inside this range fan are identified as optimal PAs for engaging the target area. Any PAs outside of the range fan are considered less than optimal. During this process, the FDO refines the planning ranges for existing conditions, in particular addressing

issues of powder temperatures, gun above or below target, met, and average MVVs (if known). See figure 10-24.

Once the S-3 identifies the optimal PAs for each target area, by phase, he/she copies them onto the operations overlay, and gives the MCOO back to the S-2. If the S-3 must use some of the less-than-optimal PAs, he/she does so understanding the constraints of those PAs. The FDO looks at each PA and identifies any technical fire delivery issues (site-to-crest, intervening crests, traverse limits, etc.) that must be resolved. When any of these issues are identified, the FDO shoots dry fire missions in the computer using data from the PA to determine if the concerns are valid. If the S-3 directs occupation of any of these PAs, the battalion FDO specifically addresses these concerns with the battery FDO.

Situation Templating

The artillery S-2 will normally receive a SITEMP from the supported infantry unit. This SITEMP, however, does not address the concerns of the artillery and must be refined to focus on fire support issues. At a minimum, the artillery S-2 must develop two SITEMPs: the most probable threat COA, and the most dangerous threat COA.

Threat Artillery

Threat artillery locations are graphically depicted down to battery level, which will affect artillery. This is performed by analyzing the artillery range capabilities of the threat artillery battalions and determining the approximate location of each battalion given its doctrinal mission. Once the S-2 determines the approximate location of each battalion, he/she situationally templates each battery location given the constraints of terrain and opposing forces. Once the S-2 has templated the battalion locations, he/she then templates the artillery range fans for each weapon system; e.g., 2S1, 2S-3, 2S5 or BM21.

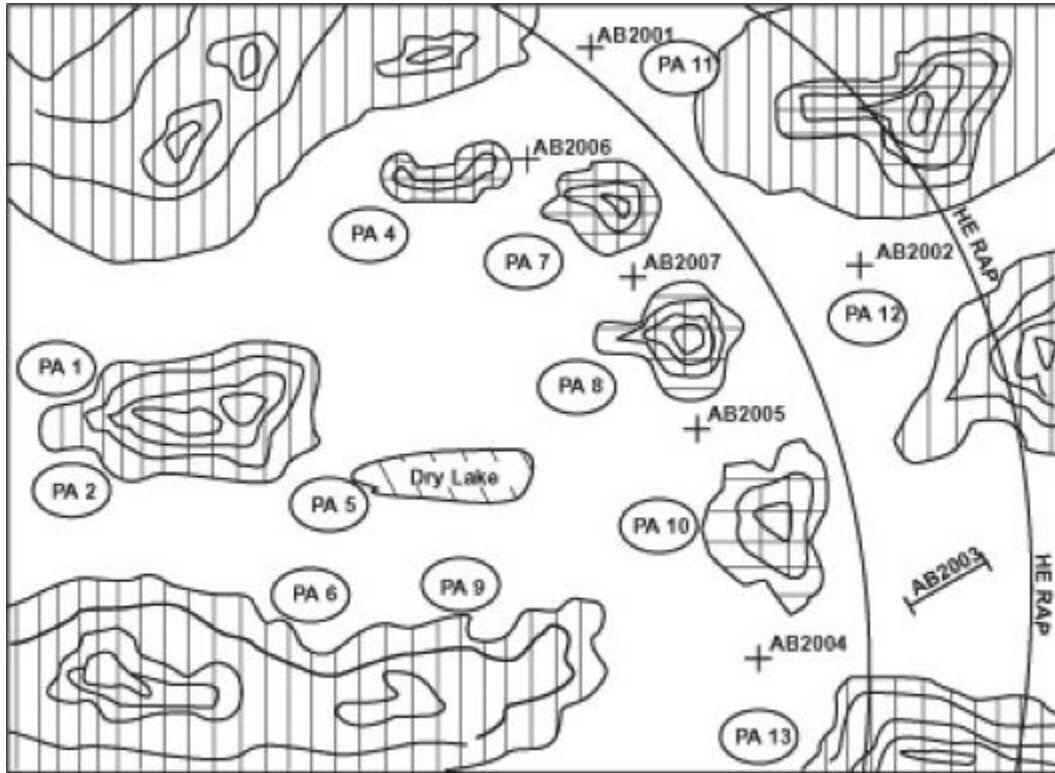

Figure 10-24. Overlay Depicting Critical Targets and Range Fans.

Threat Maneuver Forces

Formations of threat maneuver forces are graphically depicted at each point where the artillery will mass or fire special munitions missions. This is particularly important for the artillery staff because the FSC must understand the type of target that best supports the maneuver commander’s fire support guidance; e.g., group, series or linear target. The FSC must also advise the maneuver commander on the engagement criteria to use against each formation, disposition, and purpose (neutralization, suppression or destruction). An accurate SITEMP assists in making these critical decisions.

Threat Avenues of Approach and Objectives

The threat’s avenues of approach and objectives are graphically depicted. The S-2 predicts the avenues of approach the threat will use based on information from the formations he/she templated for each phase of battle. Threat objectives are predicted from the S-2’s knowledge of

threat doctrine. This is important when continuing COA development so the S-3 does not position batteries on avenues of approach and objectives.

Threat Chemical Strikes

The artillery NBC defense officer becomes involved in templating the threat’s possible persistent and nonpersistent strikes, and can advise on burst radius and downwind hazard effects. The S-3 must avoid positioning batteries in likely chemical strike and downwind hazard areas.

Rear Area Threats

The rear area insertion sites that the threat airborne/air assault units may infiltrate are templated. If possible, NAIs are nominated on these sites for artillery to watch. Since it may be difficult to avoid these areas, covering them with reconnaissance and surveillance (R&S) may be the best available option. This will impact on the execution and support of rear area operations.

Integrating the Situation Template into Course of Action Development and Wargaming

When the SITEMP is completed, the S-3 overlays it on the operations map and deconflicts positioning of firing units. The S-3 ensures that PAs are not on avenues of approach, regiment objectives or templated chemical strikes. Because it is very difficult to position out of range of the threat's artillery, the S-3 considers positioning units in areas that will cause artillery delivery problems for the threat; e.g., site-to-crest, intervening crest, and traverse limit problems. This should force the threat to execute high angle missions, which facilitates friendly target acquisition capabilities or to reposition. As the staff conducts this process, PAs that do not meet the above criteria are eliminated. With the remaining PAs, the S-3 can develop various COAs to support the commander. The staff wargames each COA against each threat SITEMP to determine the best COA.

Event Templating

The event template graphically depicts the events and timing of the upcoming battle. If artillery attempts to fight the battle without an event template it risks being forced to execute more events than are possible and thus may fail to accomplish the commander's guidance for fire support. The infantry regiment S-2 will normally provide the artillery battalion with the regiment's event templating that focuses on the regiment/division fight. The artillery battalion S-2 must refine this product to focus on fire support issues. The primary concern is the difference in the time increments used. The regiment generally fights in terms of tens of minutes and hours and therefore uses timelines in these increments. The artillery battalion's fight is executed in terms of minutes and seconds and, therefore, requires a timeline expressed accordingly.

Regiment Named Areas of Interest and Target Area of Interest

All of the infantry regiment and battalion NAIs are copied onto the artillery battalion event template. Artillery LNOs at the infantry battalions must ensure they relay their maneuver battalion's NAIs to the artillery S-2. The artillery battalion receives threat location information from maneuver elements reporting on these NAIs. The artillery battalion can then incorporate these NAIs to trigger artillery battalion events.

The S-2 draws artillery battalion NAIs identified while developing the SITEMP. These NAIs are developed to attempt to confirm or deny possible threat COAs and are executed as part of the artillery battalion's R&S plan. An artillery battalion's R&S plan consists of artillery battalion NAIs that firing units, survey teams, CSSEs, etc., will watch during the execution of their primary mission. The focus of these NAIs is to prevent the artillery battalion from being surprised by threat actions such as a rear area airborne insertion, guerilla activity or unexpected attacks along flanks or avenues of approach.

Time Phase Lines

The S-2 develops TPLs that clearly depict the pace of the fire support battle through all phases of the fight. The artillery's success or failure is determined in terms of minutes and seconds so the S-2 must use TPLs in these terms. Time increments of minutes and seconds works best; e.g., 1:10,1:20,1:30.

There are two types of TPLs: friendly offensive operations (blue lines) and threat offensive operations (red lines). Thus, if friendly units are conducting a defense, the S-2 uses red TPLs to time the threat offense. If friendly forces plan a counterattack, the S-2 uses blue TPLs to time this.

The S-2 determines the threat doctrinal movement rates using input from higher headquarter's intelligence estimates, and from the home station database he/she has built and refined. These doctrinal rates are now further refined based on METT-T.

For friendly defensive operations, the first TPL is drawn at the threat's assembly area or where friendly assets will first detect threat movement. Drawing TPLs throughout the AO continues using selected time increments. A TPL is placed at every location where the threat's movement rate is significantly altered; e.g., entering and exiting a minefield.

For friendly offensive operations, the S-2 develops TPLs for friendly attacking forces and threat counterattack forces in the same manner described. Friendly movement rates are obtained from the OPOD, unit SOPs, and the infantry battalion FSCs/artillery LNOs.

The artillery battalion uses these TPLs to understand the timing of the battle as it is occurring. This is particularly important when developing triggers/DPs for unit movements, releasing reconnaissance assets, and conducting CSS operations. The TPLs will help identify lulls in the battle and times when the artillery battalion can plan on not needing all firing units available. Performed correctly, it will become very clear when the best time is to move batteries and/or conduct other operations.

The S-2's can get a good basis for analysis from maneuver rehearsals as they cover the execution of the battle by phase. The artillery S-2 should talk with the maneuver S-2 and agree on the rates of march by phase so all fire supporters are basing triggers on the same TPLs. This requires the artillery battalion S-2 to attend or be represented at these rehearsals.

Radar Zones

The S-2 incorporates proposed radar zones onto the event template. The FSC and the artillery

staff will both generate proposed events and areas that require coverage by specific radar zones. Based on the capability of the attached radar or the number of zones allocated, the artillery battalion staff finalizes the number, type, location, queuing assets, and/or time for all approved radar zones.

The TPLs on the event template will assist the S-2 in determining a proactive queuing schedule to cover critical events such as friendly breaching operations or when the threat is conducting a particular phase of its artillery fire plan. The TPLs will also assist in determining triggers to implement or cancel planned radar zones.

Whether or not the artillery battalion has radar attached, radar zones should be shown on the event template. If the artillery battalion has a radar attached, the S-2 will complete a radar deployment order using the zones from the event template. If the artillery battalion does not have a radar attached, the S-2 will nominate the zones on his/her event template to the artillery regiment for coverage.

Decision Support Template

The DST relates the details of the event template to DPs that are of significance to artillery. It does not dictate decisions to the S-3, but rather identifies critical events and threat activities relative to time and location that may require tactical decisions. The DST provides a structured basis for using experience and judgment to reduce battlefield uncertainties. The following should occur:

- Overlay the event template on the operations graphic to depict TPLs on the battlefield. The S-3 then lists the critical fire support tasks for the battalion. These may be battalion mass missions, special munitions missions, unit movements, reconnaissance, survey operations, etc.
- Wargame each critical fire support task, in order, with the S-2 talking timing of the battle from his/her TPLs, the S-3 talking critical fire support tasks, and the FDO talking honest mission execution times.

One of the best uses of the DST for artillery is to ensure that the artillery can execute the infantry fire plans. To wargame the fire plans, the S-2 discusses the threat's COA and its rate of march, while the S-3 discusses the type of target, where the artillery is to impact (front, center, or rear of formation) and the number of rounds and volleys required. The FDO then states whether or not the artillery is laid on the target, who will fire the mission, shift time required, time of flight, and total time to execute the mission. It is critical that these are honest times based on the unit's current personnel and equipment status, and level of training. With this information, the target area in time is backed off using the TPLs, and a DP (star) is placed on the operations graphic. This star represents the point where artillery can achieve its greatest effects on the threat.

The DPs established by artillery in the forward battle area usually do not have artillery assets to watch them. These DPs should correspond to a trigger point of an infantry battalion or regimental observer. The S-3 uses these DPs as he/she tracks the battle to help him/her make critical decisions. As the S-2 identifies threat forces at or near the DPs, the S-3/FDO is alerted and expects a call for fire for the target tied to the DP. This is how the S-3 anticipates the battle to ensure

artillery is prepared to fire all required missions. In addition, if the artillery LNOs at the infantry regiments and battalions have an understanding of the mission execution times the artillery battalion is capable of, and they are coordinating their fire plans between headquarters, then the artillery battalion DST will merely verify that the fire plans are executable.

Another use of the artillery DST is to determine DPs for other critical fire support events such as battery movements, special munitions missions, radar queuing times, CSS operations, etc. In the same manner as described above, the S-3 and the staff wargame the battle determining where to place DPs which will trigger critical events. For example, the S-3 could establish a DP to que the radar to observe a breaching operation when the lead elements of the breach force report their location at a certain point.

Once completed, each DP is graphically depicted on the operations overlay. This will assist in focusing the S-3 on critical events during the battle. Time permitting, the staff may develop an execution matrix that addresses tasks each unit must execute. See figure 10-25. Figure 10-26 on page 10-36 shows fire planning using the MCPP.

	H - 0:30	H Hour	H + 0:30	H + 0:45	H + 1:00	H + 1:20
Threat Situation	Lead mechanized rifle battalions enter passes	Mechanized rifle battalions in column exit passes at obstacle	Mechanized rifle battalions in pre-battle formation	Lead mechanized rifle battalions in battle formation; trail mechanized rifle battalion enters passes	Lead mechanized rifle battalions in CO's online; trail mechanized rifle battalion exits passes	Mechanized rifle battalions in engagement areas; platoons online
NAI/DP	NAI/DP 1	DP 2	DP 3	NAI 3	DPs 4-5	NAI 3
Maneuver	Battle position set	Reconnaissance complete; CAS on station		Tows engage	Engage each viper and snake	
A Btry	Laid on AB0001	Firing AB0001	Shift/laid on AB0003	Firing AB0003	Laid on AB0004 or AB0005	Shift to AB0003 preparation to march order
B Btry	Laid on AB0001	Firing AB0001	Shift/laid on AB0003	Firing AB0003	Laid on AB0004 or AB0005	Shift to AB0003 preparation to march order
C Btry	Laid on AB0001 2 guns Copperhead AB0006	Firing AB0001, 2 guns Copperhead/ verify priority of fires	Shift/laid on AB0003	Firing AB0003	Laid on AB0004 or AB0005	Shift to AB0003 preparation to march order
COC	Retransmission operational					Jump COC moves
Trains	Jump aid station forward				Combat trains move to alternate position	

Figure 10-25. Decision Support Template and Execution Matrix.

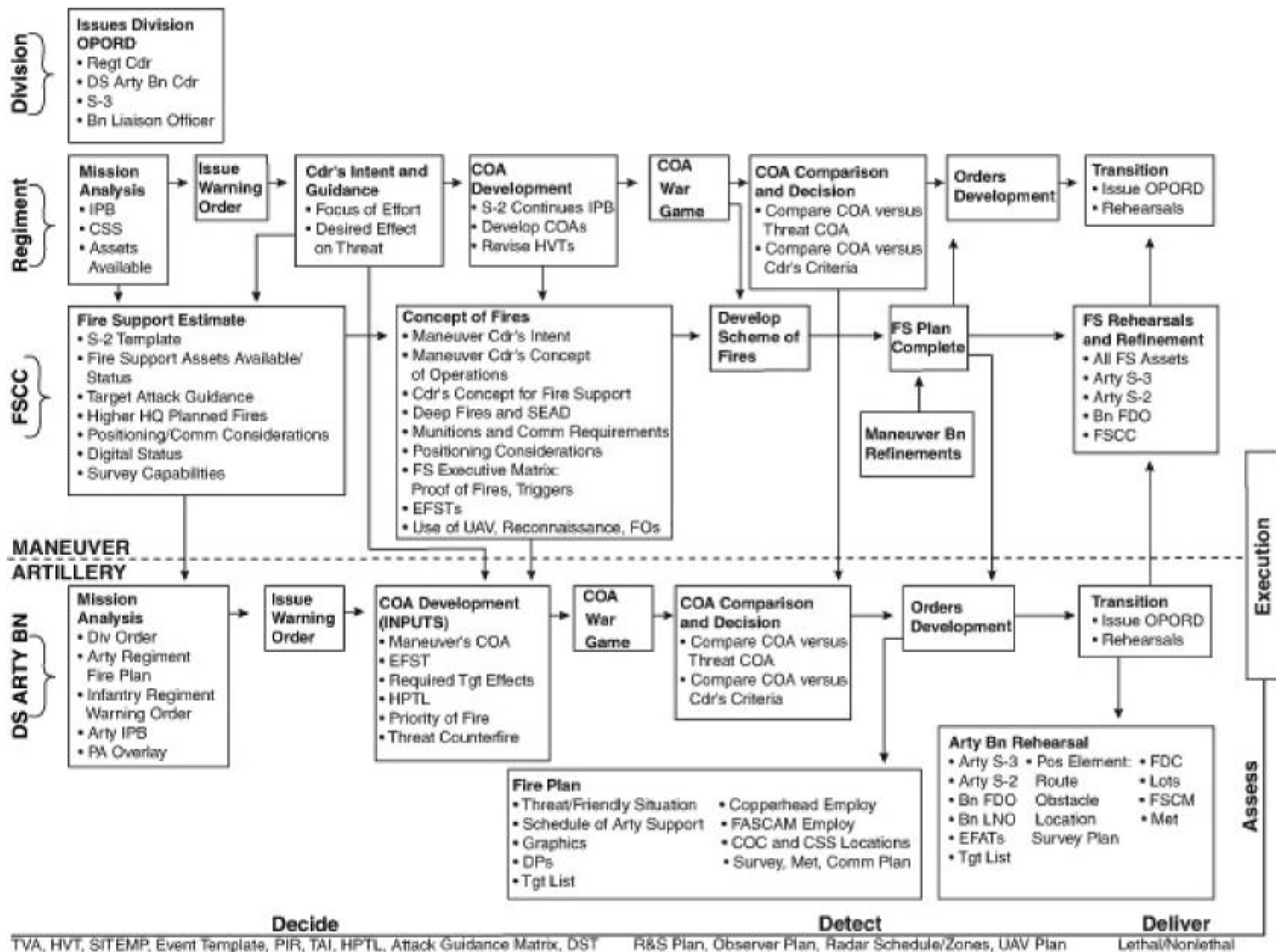

Figure 10-26. Fire Planning Using the MCPP.

SECTION IV. SAMPLE ARTILLERY FIRE PLAN

CLASSIFICATION

Copy no. _ of _copies
ISSUING HEADQUARTERS
PLACE OF ISSUE
Date/time group

TAB B (Artillery Fire Plan) to APPENDIX 19 (Fire Support) to ANNEX C (Operations) to Operation Order (Number) (U)

(U) REFERENCE:

(U) TIME ZONE:

1. (U) Situation

Provide appropriate details of the general situation with a focus on artillery support.

2. (U) Mission

Example—Attack in Zone: 1/10 (DS) and 5/10 (R) provide close fires in support of the 2d Marines attack in zone not later than 100400NOV00 to destroy the threat forces in order to reestablish the FLOT along PL Blue.

Example—Movement to Contact: 1/10 (DS) and 5/10 (R) provide close fires in support of the 2d Marines movement to contact in zone not later than 100400NOV00 to destroy the 49th Tank Brigade's stay behind forces. On order, 2d Marines will establish crossing sites for the passage of 8th Marines along PL Red.

3. (U) Execution

a. (U) Commander's Intent (artillery battalion commander)

b. (U) Concept of Artillery Support. This is a detailed statement of the artillery commander's vision of artillery support. It details what the artillery is going to do to support maneuver elements and meet the maneuver commander's intent.

Page number

CLASSIFICATION

CLASSIFICATION

- c. (U) Organization for Combat. Details the organization and tactical missions by phase (include organic and reinforcing artillery and anticipated O/O missions).
- d. (U) Tasks to Subordinate Units. Include tasks by unit by phase and include EFAT tasked to specific batteries.
- e. (U) Coordinating Instructions. Includes instructions and details for coordination for two or more subordinate elements. These instructions may be included as enclosures to the order. If enclosures are used, then include only those items of generic interest. The following is a list of coordinating instructions that should be addressed:
- Target acquisition.
 - Survey/met.
 - Automated fire control (AFATDS/IFSAS/ BCS).
 - High-payoff target list.
 - Attack guidance matrix.
 - NBC defense.
 - Liaison requirements.
 - PIRs.
 - Ammunition restrictions.
 - FSCMs.
 - Rehearsals.
4. (U) Administration and Logistics
- Refer to Annex D (Logistics), Annex P (Combat Service Support), and/or administrative/logistic orders. Identify ammunition availability, allocations, and ammunition management measures.

CLASSIFICATION

5. (U) Command and Signal

Identify command relationships as required, signal information, and command post information; e.g., location of artillery headquarters afloat and initial positions ashore.

- a. (U) Command Relationships. As required.
- b. (U) Signal
- c. (U) Command Posts

ACKNOWLEDGE RECEIPT

/s/

ENCLOSURES:

- 1 Artillery Target List
- 2 Artillery Synchronization Matrix
- 3 Artillery Target Overlay
- 4 Schedule of Fire
- 5 Observation/Target Acquisition Plan
- 6 Survey/Met Plan

Page number

CLASSIFICATION

CLASSIFICATION

ENCLOSURE 1 (Artillery Target List) to TAB B (Artillery Fire Plan) to APPENDIX 19 (Fire Support) to ANNEX C (Operations) to Operation Order (Number) (U)

[1 st Mar, 1 st MARDIV] Target List Worksheet									
OPOD _____ For use of this form see FM 6-20-40; Proponent agency is TRADOC									
DATUM: WGS-84									
SHEET ____ of ____									
Line No	Target No	Description	Location	Altitude	Altitude	Size		Source/ Accuracy	Remarks
						Length f	Width g		
1	AC0001	120 mm Mortar Plt	499377		e			h	i
2	AC0002	Rifle Company	516325						DPICM
3	AC0003	Rifle Platoon	554296						
4	AC0004	OP	570281						VT 50%; WP 50%
5	AC0005	MG Position	566260						
6	AC0006	Trail Intersection	572247						CP 11
7	AC0007	Comm Site	489254				Radius 400		
8	AC0008	Road Intersection	493250	2400			400		
9	AC0009	AOA	512245						
10	AC0010	Trail Intersection	525231						CP 28

CLASSIFICATION

ENCLOSURE 2 (Artillery Synchronization Matrix) to TAB B (Artillery Fire Plan) to APPENDIX 19 (Fire Support) to ANNEX C (Operations) to Operation Order (Number) (U)

		Phase 1	Phase 2	Phase 3	Phase 4	
Phases		LD to Obj Penny	Obj Nickel	Obj Dime	Obj Quarter	
Threat		Cntr-Btry threat-Med	Cntr-Btry threat-Med	Cntr-Btry threat-High		
MVR	1/7	(SE) Rte April to clear Obj Sixpence	Mvmt to Contact along Rte April to PL Quiver	Atk to seize Obj Ring	Defend Obj Ring	
	2/7	(ME) Mvmt to Contact Rte Julie to clear Obj Penny	Along Rte Julie, Atk to seize Obj Nickel	1st LAR Fwd Pass. of lines. Helo Co to SBF 1 Become Regt reserve		
FSCMs	CFL	PL Quiver % PL Archer	PL Diamond		▶	
	FSC	PL Ruby			▶	
		Event Trigger	Event Trigger	Event Trigger	Event Trigger	
Btry I	Move	1. PA 9 AoF 1600 2. PA 32 AoF 100	1. N/A 2. %		2. R3P vic CP 56 2. EOM AD2003	1. PA 33 AoF 1. R3P complete
	Essential Task	1. Mass Bn (AID): Btry 2 - AD 2001	1. 1/7 at PL Orange		1. Fire Smoke - AD 2003 1. 2/7 clears Obj Dime	1. Mass Bn (A3D): Btry 2 - AD 2007 1. En. Crosses PL Arrow
Btry K	Move	1. PA 10 AoF 1600	1. N/A	3. PA 28 AoF 1500 3. EOM AD0014		
	Essential Task	1. Mass Bn (AID): Btry 3 - AD 2002	1. 1/7 at PL Orange	1. Fire CPHD AD0003,2 Rds 2. Fire Smk 20 min - AD0014	1. A/1/7 acquires 2. 1/7 crosses PL Quiver	1. Mass Bn (A3D): Btry 2 - AD 2007 1. En. crosses PL Arrow
COC		Move to PA 32 when K FIRECAP			▶	
Survey		Pri: L, K	Pri to A/1/7/ OP, Vic 435427, K, L	Pri: K, L		
Radar		N/A			▶	
Field Trains/LOC		AA Red/PA 1	Move to PA 37 when Bn clear PL Bow			
Ammo/POL				R3): Btry 1 Class I, V, IX vic CP 56	R3P: Btry K Class I, V, IX vic CP 56	
BAS		Colocated with Field Trains/LOC			▶	

CLASSIFICATION

ENCLOSURE 3 (Artillery Target Overlay) to TAB B (Artillery Fire Plan) to APPENDIX 19 (Fire Support) to ANNEX C (Operations) to Operation Order (Number) (U)

(U) REFERENCE: Map

The overlay contains artillery targets, FSCMs, and unit boundaries.

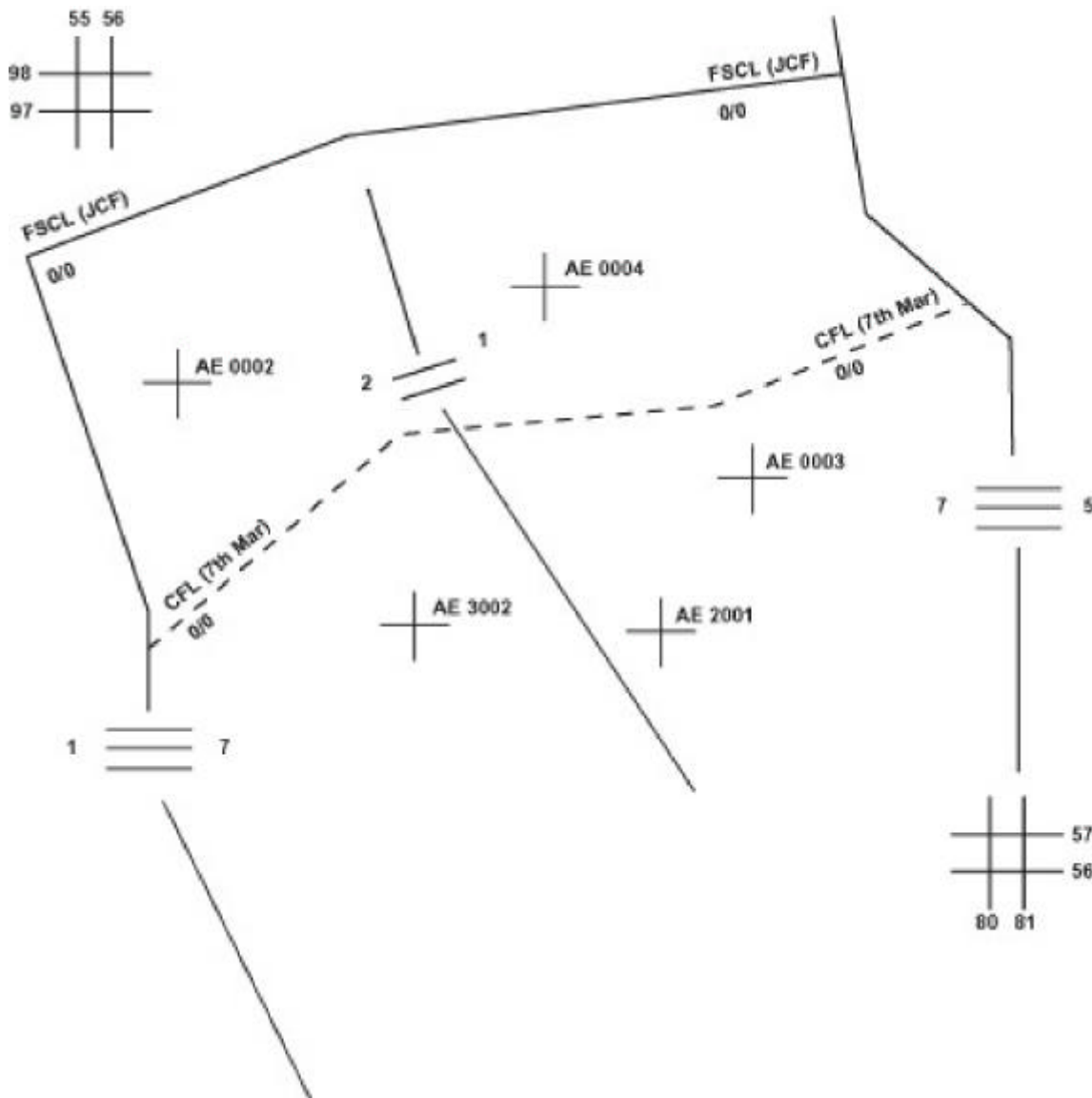

Page number

CLASSIFICATION

CLASSIFICATION

ENCLOSURE 4 (Schedule of Fire) to TAB B (Artillery Fire Plan) to APPENDIX 19 (Fire Support) to ANNEX C (Operations) to Operation Order (Number) (U)

(Groups for 7th Mar)
OPORD Jungle Strike

SCHEDULING WORKSHEET
For use of this form see FM 6-20-40; the proponent agency is TRADOC

DTM: WGS-BM

SHEET 1 OF 1

Line No.	Organization and Caliber	Firing Units											Remarks		
			(A1E)	(A2E)											
1	3/11	J	AE0003 18 (b)	AE0001 6											
2	(155, T)	L	AE0002 18 (b)												
3		K	AE0002 18 (b)	AE0003 6											
4	USS CHIPPILL 5in62	MT 1	AE0004 35												
															(a) HE/VT

(Series Dog for 2d Bn, 7th Mar)
OPORD Jungle Strike

SCHEDULING WORKSHEET
For use of this form see FM 6-20-40; the proponent agency is TRADOC

DTM: WGS-BM

SHEET 1 OF 1

Line No.	Organization and Caliber	Firing Units											Remarks		
			1	2	3	4	5	6	7						
1	1/12	A	AE0003 18 (a)		AE0001 6										
2	(155, T)	B	AE0002 18 (a)			AE0004 18 (a)									
3		C	AE0002 18 (a)		AE0001 6 (b)										
4	USS CHIPPILL 5in62	MT 1		AE0004 35											
															(a) HE/VT (b) Provide WP Mark

CLASSIFICATION

ENCLOSURE 5 (Observation/Target Acquisition) to TAB B (Artillery Fire Plan) to APPENDIX 19 (Fire Support) to ANNEX C (Operations) to Operation Order (Number) (U)

(U) REFERENCE: Map

(U) TIME ZONE:

1. (U) Situation

This paragraph should include the friendly situation, supported units, and other target acquisition assets in sector. Include specific threat and friendly assessments that form a basis for threat assessments required on the radar deployment order.

2. (U) Mission

This paragraph should be a clear, concise statement of the target acquisition mission.

3. (U) Execution

This paragraph contains the subparagraphs described below.

a. (U) Concept of Operation. This subparagraph gives the commander's concept for target acquisition. This should include identification of designated cueing agents and general cueing guidance. This guidance may include general instructions for offensive and defensive phases of the operation. Specific cueing guidance is listed in the coordination subparagraph.

b. (U) Processing. This subparagraph is used to denote target processing flow. This targeting information flow describes the relationship between the unit that acquires the target and the headquarters controlling the radar. This subparagraph does not represent the actual communications nets used but shows the destination flow of targeting information. This subparagraph should list all field artillery target acquisition assets and headquarters controlling them. The following are examples of the types of information that may be included in the processing subparagraph—

(1) (U) AN/TPQ-46A section reports targets to the supported artillery battalion COC.

(2) (U) AN/TPQ-37 section reports targets to the division or MEF targeting cell.

Page number

CLASSIFICATION

CLASSIFICATION

- (3) (U) Aerial fire support observer reports targets to the controlling headquarters COC.
 - (4) (U) DS battalions report targeting data to the regiment COC.
 - (5) (U) Any violations of CFZ or CFFZs will be sent directly from the radar to the associated artillery battalion.
- c. (U) Visual Observation. This subparagraph includes ground and air observation. Ground observation is covered in Enclosure 1 to the target acquisition tab, which is the consolidated visibility diagram. Air observation should include UAV assets attached or in support of the operation.
- d. (U) Radar. This subparagraph deals with the missions and C2 relationships assigned to the fire finder radars. Radars may be attached to artillery battalion headquarters or higher artillery headquarters. The attached radar assumes the mission of the supported unit; e.g., DS or GS.
- (1) (U) An example mission for an AN/TPQ-46A Team might be as follows:
 - (U) AN/TPQ-46A Team 1, HQ Btry 10th Mar; Mission:
Attached to 1st Bn 10th Mar. (DS). (See radar deployment order, Exhibit 3.)
- a. (U) Coordination. This subparagraph covers information that is not addressed in the unit SOP. As a minimum, it should contain the following:
- (1) (U) The requirement for the supported DS battalion to report its radar locations and sectors of search to the regiment TPC.
 - (2) (U) Cueing guidance assigned.
 - (3) (U) Common sensor boundary. Fire finder radars sharing or having overlapping search sectors need to be identified. Consideration must then be given to establishing a CSB. A CSB is indicated by a series of grid coordinates to define its location.
 - (4) (U) Coordination for communications nets and relays, if required.
 - (5) (U) Additional coordination for met, survey and security, if required.
4. (U) Service Support. This paragraph lists additional service support requirements as required. It may refer to the service support annex.

Page number

CLASSIFICATION

CLASSIFICATION

5. (U) Command and Signal. This paragraph lists required information as necessary. It may refer to the fire support appendix.

EXHIBITS:

1. Consolidated Visibility Diagram
2. Consolidated Capabilities Overlay
3. Radar Deployment Order

Page number

CLASSIFICATION

CLASSIFICATION

EXHIBIT 1 (Visibility Diagram) to ENCLOSURE 5 (Observation/Target Acquisition) To Tab B (Artillery Fire Plan) to APPENDIX 19 (Fire Support) to ANNEX C (Operations) to Operation Order (Number) (U)

Information Included:	Map	Radar Grid
	Series	Primary Az
	Created by	Left Az
	Unit	Right Az
	DTG	Alt Az
	Weather	Left Limit
		Right Limit

Fire Finder Position Analysis System (FFPAS) located with the radar officer will produce a visibility diagram and is recommended.

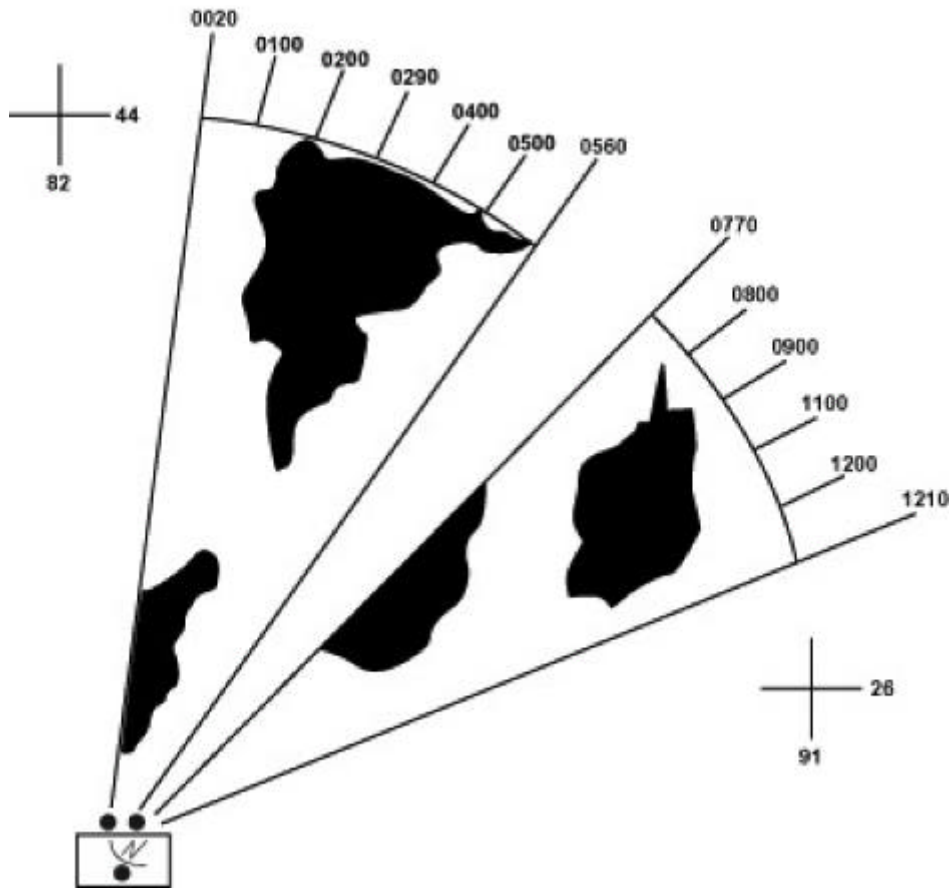

CLASSIFICATION

EXHIBIT 2 (Capabilities Overlay) to ENCLOSURE 5 (Observation/Target Acquisition) To Tab B (Artillery Fire Plan) to APPENDIX 19 (Fire Support) to ANNEX C (Operations) to Operation Order (Number) (U)

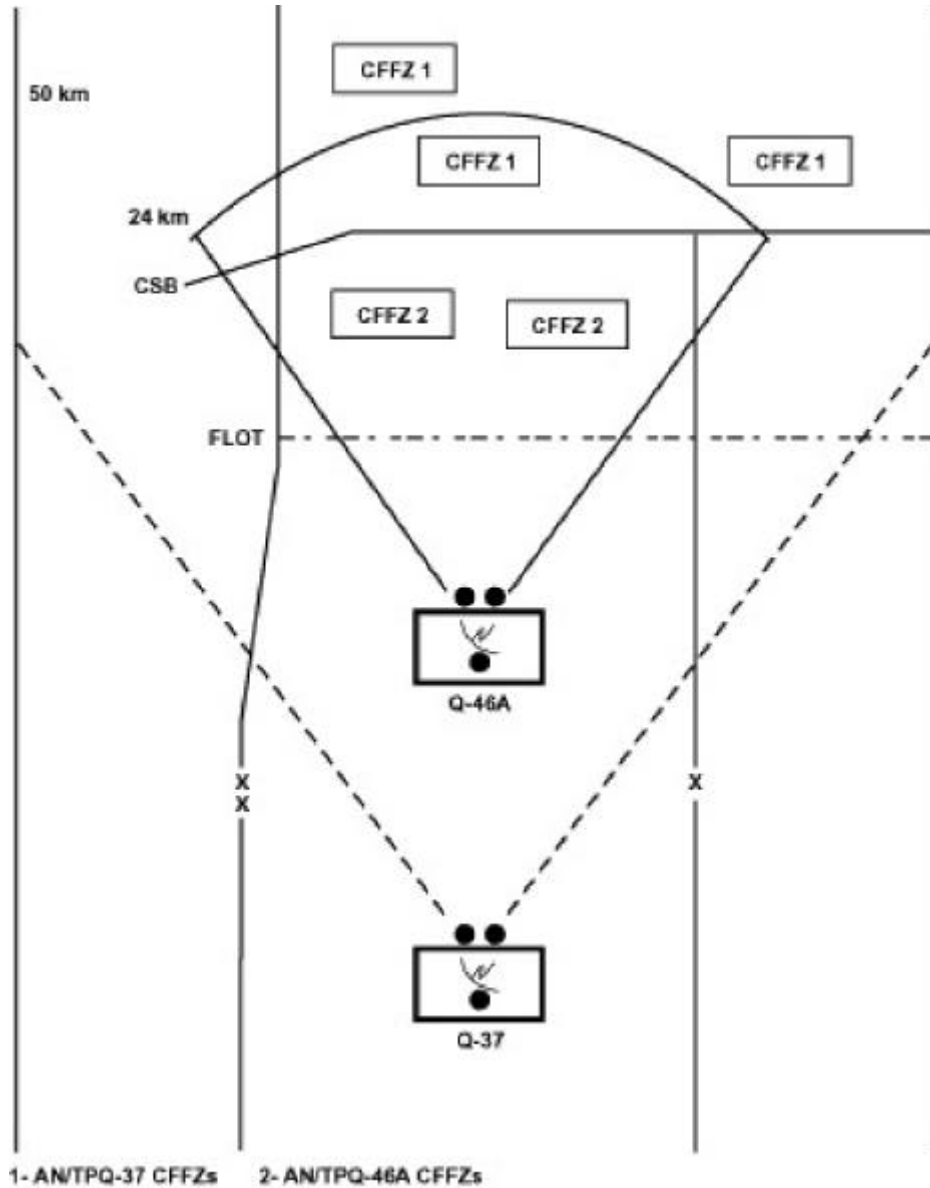

CLASSIFICATION

EXHIBIT 3 (Radar Deployment Order) to ENCLOSURE 5 (Observation/Target Acquisition) To Tab B (Artillery Fire Plan) to APPENDIX 19 (Fire Support) to ANNEX C (Operations) to Operation Order (Number) (U)

RADAR DEPLOYMENT ORDER							
For use of this form, see FM 6-121. The proponent agency is TRADOC.							
SECTION				MISSION			
MISSION		PRIMARY		ALTERNATE			
SEARCH SECTOR							
				Left Edge	Right Edge	Min Range	Max Range
Primary Azimuth				Mils	Mils	Meters	Meters
Alternate Azimuth				Mils	Mils	Meters	Meters
EW THREAT ASSESMENT							
EW Threat (Yes or No)		Affecting Friendly Assets (Yes or No)			Type of Threat (Air or Ground)		
Note: Use the Fire Finder survivability flowchart in FM 6-121 to determine emission limits.							
CUEING AGENTS (CALL SIGN AND DESIGNATION) IN PRIORITY							
REPORTING CHANNELS							
ZONE DATA							
Type and Number	Description and/or Command Priority	Grid Coordinates of Zone Corner Points					

DA Form 5957-R, Sep 1990

CLASSIFICATION

ENCLOSURE 6 (Survey/Met Plan) to TAB B (Artillery Fire Plan) to APPENDIX 19 (Fire Support) to ANNEX C (Operations) to Operation Order (Number) (U)

This enclosure provides information on survey and meteorology operations. Requirements and methods of dissemination are addressed. Support requirements to other units/agencies; e.g., radar beacon teams, are identified.

(U) REFERENCE:

(U) TIME ZONE:

1. (U) Situation. This paragraph consists of the units who will have an affect on the survey plan.

- Threat. Intelligence and information on the threat that may affect survey operations (routes, weapons, etc.)
- Friendly. The friendly (higher, lower, and adjacent units) situation as it affects survey and met operations.
- Attachments and detachments. Units who can provide support to survey operations (security, maintenance, other survey teams).

2. (U) Mission. This is a clear, concise statement of the task to be performed by the survey and met section. It should answer who, what, where, when, why.

3. (U) Execution. This paragraph consists of several subparagraphs that answer the how.

- Concept of operations. This subparagraph describes the survey and meteorological methods to be used.
- Specific instruction to each party. These subparagraphs contain specific instructions each team requires to accomplish its portion of the mission. This information includes survey control to be used by the teams, general locations (six-digit grids) for required control, frequency and location of met reports, and information that deviates from SOPs. These instruction should be in concert with the EFATs.
- Coordinating instructions. Information required by two or more parties.

Page number

CLASSIFICATION

CLASSIFICATION

4. (U) Administration and Logistics. This paragraph contains the necessary information to ensure CSS is adequate for the mission. Information on reporting, classes of supply, handling of prisoners, and location of the aid station will be addressed.
5. (U) Command and Signal. Addresses the location of the survey officer/chief, frequencies, call signs, casualty evacuation procedures, and communications between survey/met teams.

Page number

CLASSIFICATION

CHAPTER 11

SPECIAL OPERATIONAL ENVIRONMENTS

Terrain, weather, the nature of an operation or a combination can create a need for special techniques, tactics, training, and equipment. Special operational environments are cold weather, mountain, desert, jungle, riverine, river crossing, expeditionary, helicopterborne, urban, artillery raid, and fire base.

Cold Weather				
ORGANIZATION FOR COMBAT	MOVEMENT/POSITIONING	DELIVERY OF FIRE	SECURITY	C3
<p>Because unit density is usually low, attachment of artillery may be required.</p>	<p>Movement of wheeled vehicles restricted and slow. Artillery is nearly road bound.</p> <p>Chains required for prime movers. Consider using wreckers.</p> <p>Heavy vehicles move with difficulty in deep snow or muskeg.</p> <p>A large battlefield requires movement. Navigation is difficult.</p> <p>Air movement affected by ice/fog. Movement by helicopter makes large signature. CSS to artillery positions by helicopter may be difficult.</p> <p>Positions selected for tactical utility, protection from the elements, and ease of CSS. Firing positions may be on or near roads, in farm yards, etc. Positions will often have limited space. Old positions can be used as supplementary positions or for ammunition storage.</p> <p>Two methods of snow clearing positions are racetrack and driveway methods.</p> <p>Positions require increased time for preparation. Dunnage may be required.</p> <p>Ahkios (man-portable sleds) can move equipment and ammunition in position.</p>	<p>Ammunition effects are reduced by snow, increased by ice. HE/Q and ICM ineffective in deep snow. HE/Q can start avalanches. MTSQ fuzes are effective. Chemical agents are adversely affected. WP particles may become buried in snow and cause hazard to friendly troops.</p> <p>Cold affects weapons. Rates of fire are reduced until weapons have warmed. Ammunition preparation is slow. Range correction factor of $\pm 100m$ per 1,000m is uncommon.</p> <p>Survey is difficult. Survey control points and markers become obscured. Survey parties need equipment for over-the-snow travel.</p> <p>Radar operations are hampered by extreme cold.</p> <p>Firing platform stability is a problem in deep snow.</p> <p>Ensure positions are away from possible avalanche-prone areas.</p> <p>FASCAM may settle in deep snow and reduce effectiveness.</p> <p>Projectile plugs should be left in place or fuzes immediately mated with projectiles to prevent condensation, ice or snow in the fuze well.</p>	<p>Hardening of positions is difficult. Construction of barriers, parapets, etc., on frozen ground may require explosives.</p> <p>Engineers may be attached to artillery for snow clearing, hardening of positions, and fortifications.</p> <p>Track plans must be strictly enforced to prevent compromise of position by tracks in snow.</p> <p>DS and attached artillery may be located adjacent to or within perimeter of infantry.</p> <p>Concentrations of shelters make unit vulnerable to attack.</p> <p>Camouflage discipline must be strictly enforced.</p>	<p>Communications primarily by radio. Wire use restricted to existing trails and roads. Wire may be laid by aircraft. Wire must be kept in warm place until laid.</p> <p>Due to decreased mobility, communications security and electronics security have added importance.</p> <p>Artillery commander must ensure supported unit aware of limitations of artillery in cold.</p>

Mountain				
ORGANIZATION FOR COMBAT	MOVEMENT/POSITIONING	DELIVERY OF FIRE	SECURITY	C3
<p>Terrain often requires multiple maneuver columns; attached artillery may be required.</p>	<p>Movement of vehicles slow and restricted to roads and improved trails, which are usually scarce. Winding roads and steep slopes create difficulty for towed weapons.</p> <p>Self-propelled artillery traction difficult when road is rocky or icy. Can be overcome by grousers (cleats) on the tracks.</p> <p>Potential for bottlenecks. Artillery needs route precedence.</p> <p>Helicopter movement may be restricted by altitude limitations.</p> <p>Positions will usually be scarce and access limited.</p> <p>Artillery must be prepared to fire from roads.</p> <p>High altitude lowers load capacity of vehicles.</p>	<p>High angle fire often required because of masks of positions and for defilade fire.</p> <p>Observed fires and frequent corrections for nonstandard conditions are required. Consider check rounds. Massed fires are less effective because of enemy dispersion. However, chokepoints and passes are ideal targets.</p> <p>Counterfire is particularly effective due to high angle fire. Positions can be predicted because of few available positions.</p> <p>Rocky ground enhances lethality of HE; airbursts effective on reverse slopes; ICM, smoke, and illumination fires difficult to adjust and maintain due to winds.</p>	<p>All-around security is critical because of terrain.</p>	<p>Decentralized in the attack; centralized in the defense.</p> <p>Radio communications often degraded; use of radio relays required.</p> <p>Antennae must be carefully sited and masked.</p> <p>Wire laying restricted to roads. Cross-country wire difficult to lay and maintain.</p>
Desert				
<p>Wide dispersion of forces may require attachment of artillery.</p> <p>Desert battles tend to be centralized.</p>	<p>Wheeled vehicle movement difficult with heavy loads. Roads are normally poor.</p> <p>Displacements will usually be frequent because of fluidity of battlefield. Units should carry mission-essential loads.</p> <p>Movements should occur during periods of reduced visibility when possible. Day movement causes dust signature.</p> <p>Helicopter operations difficult due to dust.</p> <p>RSOP and survey must be continuous. Often, air reconnaissance is used.</p> <p>Terrain gun positioning is widely used to take advantage of terrain.</p> <p>Consider potential changes in weather when selecting positions.</p> <p>Navigation difficult.</p> <p>Use caution in operating in wadis, particularly if rainstorms are likely.</p>	<p>HE/Q and delay, ICM, and FASCAM smothered by deep sands. Airbursts, smoke, illumination, and Copperhead are very effective.</p> <p>Long-range fires and obscuration and screening fires can be expected.</p> <p>Rapid changes in weather require frequent changes in corrections for nonstandard conditions.</p> <p>Radars highly effective.</p> <p>Most targets will be hardened.</p> <p>Survey control points are few and far between. Astronomic observation and resection may be required.</p> <p>Soft sand causes problems in firing of weapons.</p> <p>Plan for increased consumption rate of ammunition.</p>	<p>Security takes on added importance.</p> <p>Artillery vulnerability is increased by firing signature and openness of terrain.</p> <p>Positions must be well-dispersed, hardened, and camouflaged.</p> <p>Deception should be practiced, but is difficult.</p>	<p>Radio communications generally excellent, but vulnerable to EW and damage by sand, heat, etc.</p> <p>Wire is easy to install in most areas.</p> <p>For short ranges, visual and sound signals may be used.</p> <p>Some areas may have dead spots.</p>

Jungle				
ORGANIZATION FOR COMBAT	MOVEMENT/POSITIONING	DELIVERY OF FIRE	SECURITY	C3
<p>Communications may necessitate decentralized control.</p> <p>Supported units often conduct decentralized or independent operations.</p>	<p>Limited trafficability for wheeled and tracked vehicles on few existing roads. Loads must be kept light.</p> <p>Air movement essential.</p> <p>Mutually-supporting positions should be selected when possible.</p> <p>Positions are usually scarce and may be inaccessible by road. Thus, air resupply will be required.</p> <p>Positions may have to be cleared.</p> <p>Positions are normally compact for control and security.</p> <p>Positions for radars usually limited.</p> <p>Air reconnaissance and aerial photographs useful.</p> <p>Positions are often hampered by soft terrain. Engineer support or dunnage may be required.</p> <p>Distance between march elements are reduced and other security measures intensified because of limited visibility and natural obstacles. Flank security is a continuing requirement.</p> <p>Thorough RSOP essential.</p>	<p>Firing platforms may be required for stability in swampy areas.</p> <p>6400-mil firing capability may be required.</p> <p>Canopy of jungle affects ammunition effectiveness and functioning. HE delay needed to penetrate canopy.</p> <p>Radars have reduced range and accuracy.</p> <p>Danger close may be frequent.</p> <p>High angle fires are common.</p> <p>Survey control slow and must be established when feasible.</p> <p>Humidity may degrade range.</p> <p>Ammunition must be protected from moisture.</p> <p>Unobserved or predicted fires are often used. Adjustment by sound and the use of creeping fires are common.</p> <p>HE/Q can be used in low tree canopy or grassland, often producing a splintering effect.</p>	<p>All around security and hardened positions must be established.</p> <p>Positions in thick vegetation areas increase vulnerability to ground attack.</p> <p>Integrated security plans are established.</p>	<p>Radio communications are restricted by line of sight, dense vegetation, and adverse weather conditions. Range of radios is usually reduced by as much as 40 percent.</p> <p>Antennae siting are critical. Field expedient and directional antennae are used. Antennae may have to be elevated to achieve line of sight.</p> <p>Wire laying restricted to roads. Wire can be laid by helicopter.</p>
Riverine				
<p>Widely dispersed force may require attached artillery.</p> <p>Quantity and caliber of artillery may be limited by lack of positions and water transport assets.</p>	<p>Movement primarily by landing craft and helicopter.</p> <p>Artillery may have to be positioned in hostile area before attack begins.</p> <p>Tidal conditions and water level may affect movement.</p> <p>Buoy markers should be placed on howitzers and prime movers to help recovery in event of sinking.</p> <p>Naval radar aboard escort watercraft can be used for position location.</p>	<p>Batteries must be prepared for direct fire for self-defense.</p> <p>Fires without observation may be inaccurate because of lack of survey control and valid met data.</p> <p>If afloat, FDCs are generally semi-permanent on separate landing craft.</p> <p>Fires can be delivered from the LCM-8 or barges while anchored to the bank.</p>	<p>Additional forces for the security of prepositioned artillery.</p> <p>Position areas may be small and in insecure areas. Cover and concealment may be limited.</p> <p>Naval element gunboats and assault support patrol boats provide boat security.</p> <p>CAS, close-in fire support, and supporting artillery are requested for route security as required.</p>	

Riverine (Continued)				
ORGANIZATION FOR COMBAT	MOVEMENT/POSITIONING	DELIVERY OF FIRE	SECURITY	C3
	<p>Position locations for barge- and boat-mounted artillery should have—</p> <ul style="list-style-type: none"> ● Steep banks below surface. ● Wide streams to front and rear to reduce danger from ground attack. ● Limited avenues of approach over land. ● Areas that minimize anchorage problems. 			
River Crossing				
<p>Artillery is organized for combat consistent with type of crossing to be conducted (hasty or deliberate) and intended mission after crossing. When practical, centralized control is desired.</p> <p>In the defense, artillery may be attached to security forces deployed across river.</p>	<p>Most artillery will cross the river when continuous fire support can be delivered from the far bank.</p> <p>DS artillery displaces when first phase objectives are seized and positions are available for artillery.</p> <p>Some artillery may be airlifted to reduce congestion at the crossing site.</p> <p>In the assault, final positions are moved into at the last possible moment under cover of darkness. Positions should be well forward and in depth to range beyond the bridgehead line. Positioning should facilitate rapid crossing. RSOP is accomplished by map. There is little flexibility in selecting initial positions.</p>	<p>GS and GS-R units may provide close supporting fires as DS and reinforcing move.</p> <p>Before, during, and after crossing, artillery may deliver illumination, smoke, and deception fires. Fires can be used to screen noise of crossing.</p> <p>In the defense, fires may be planned on probable crossing sites, fires to canalize the enemy and stall his/her attack astride the river, and to support a counterattack. Fires are delivered in depth.</p>	<p>When supporting force crosses river, local security becomes critical.</p>	<p>May be complicated when elements are on both sides of the river.</p>
Expeditionary Operations				
<p>Because artillery is dispersed among available naval shipping, decentralization is required. As artillery lands, centralization is re-established as dictated by the situation.</p>	<p>Artillery should land and begin operations as soon as conditions permit. Artillery RSOP parties are usually brought ashore in the early stages of the landing, with artillery units landed as on-call serials.</p> <p>Initial position areas are planned from map reconnaissance, and if possible by air. RSOP parties will be larger in the initial phase of the operation than in other operations.</p> <p>Survey control must be established ashore.</p>	<p>Tactical and technical fire direction must be decentralized initially to allow for flexibility.</p> <p>Be prepared for inter-service call for fire.</p> <p>Artillery may be positioned on offshore islands to support assault.</p> <p>Survey should be pushed ashore early.</p>	<p>Artillery vulnerable while on the beach. Units must move across the beach as rapidly as possible.</p>	<p>Senior artillery commander is usually an embarkation unit commander.</p> <p>Communications while afloat and during ship-to-shore depend on ship communications plans. Radio is usually the primary means. Most artillery traffic will be on LF/artillery command/FD and artillery command nets.</p>

Expeditionary Operations (Continued)				
ORGANIZATION FOR COMBAT	MOVEMENT/POSITIONING	DELIVERY OF FIRE	SECURITY	C3
	<p>Beach trafficability may be a problem. Matting and partially deflated tires may be used. Vehicles must be prepared for fording.</p> <p>Artillery may be landed by landing craft or helicopter.</p> <p>Landing plan must permit artillery to land in formation with adequate personnel/equipment to support the fire support plan and scheme of maneuver.</p>			
Helicopterborne				
<p>Decentralized operations may be required to support small task forces.</p>	<p>Mutual support between artillery units is desirable.</p> <p>6400-mil firing capability.</p> <p>Reconnaissance may be limited to air, with the battery commanders conducting reconnaissance during the assault with elements of the supported force.</p> <p>Battery formations often dictated by the terrain of the LZ. Ammunition should be placed close to howitzers on occupation.</p> <p>Positions should have area for LZ.</p> <p>Reconnaissance and HST teams may be available for terminal guidance of aircraft.</p> <p>Position loads to reduce fly over of battery consistent with wind direction.</p>	<p>Individual piece corrections may be required.</p>	<p>All-around security required.</p> <p>Make use of defilade and natural obstacles.</p>	<p>Close liaison between artillery and helicopter units required.</p> <p>Primary means of communications is radio.</p> <p>Wire restricted to installations within LZ and rear areas.</p>
Urban				
<p>Centralized control during initial phases; decentralized control during later phases to support semi-independent action of small units.</p>	<p>Movement during night or periods of reduced visibility when possible.</p> <p>Few displacements, often by platoon or section.</p> <p>Select positions that minimize masking, provide several routes of escape, and afford as much cover and concealment as possible. Use of existing structures (garages, office buildings, highway overpasses) is recommended.</p> <p>RSOP parties should be well armed, as they may have to clear areas to be occupied. Extensive route reconnaissance is required.</p>	<p>Both direct and indirect fires are delivered for supported units.</p> <p>Destruction of fortifications may require assault fire techniques.</p> <p>High angle fire may be required.</p> <p>Need for accurate met and survey increases, as most targets are point targets.</p> <p>Lasers and precision guided munitions permit destruction of targets with minimum rubble of adjacent buildings. But tall buildings may hamper laser use.</p> <p>Batteries must be prepared for hasty survey techniques.</p>	<p>Fortification of position.</p>	<p>Radio communications impaired by buildings.</p> <p>Wire can usually be run overhead.</p> <p>Make use of civilian communications.</p> <p>More use of messengers and prearranged audio and visual signals.</p>

Urban (Continued)				
ORGANIZATION FOR COMBAT	MOVEMENT/POSITIONING	DELIVERY OF FIRE	SECURITY	C3
	<p>Special techniques for emplacing howitzers, such as spades against a curb when the ground is not suitable for emplacement, may be required. Explosives may be required to soften emplacement of howitzers.</p> <p>Target acquisition devices somewhat degraded.</p> <p>Emplace radars to cover likely areas of enemy indirect fire weapon employment. Avoid placing radars in the midst of an urban area because of masking.</p>	<p>ICM and VT effects reduced by structures, although they are effective against personnel on rooftops and top floors. HE/CP used for penetration effects. Illumination, chemical incendiary ammunition, and smoke are effective.</p> <p>Ammunition expenditures will be heavy.</p> <p>Magnetic instruments are impaired.</p>		
Artillery Raid				
Extremely decentralized.	<p>Battery moves rapidly into position by air or ground means. The position may be across the FEBA.</p> <p>Only bare necessities are taken.</p> <p>The number of howitzers taken forward depends on the target analysis, effects required, and aircraft availability (if airlifted).</p>	<p>Raid is extremely short; used to deliver fire on a HVT.</p> <p>A mixture of HE, WP, and ICM provides excellent effects for a raid. FASCAM and DPICM are also useful.</p> <p>Firing data can be precomputed.</p> <p>Fire the highest charge possible to increase standoff range.</p>	<p>Security elements accompany raid. Attack helicopters may provide cover.</p>	<p>Detailed planning, surprise, and speed are key factors in execution.</p> <p>Effective SOP is essential.</p>
Fire Base				
Generally centralized.	<p>Positions should be in an open field, possibly on a hilltop, so unit can clear kill zones, have interlocking fields of fire, and maximize grazing fire.</p> <p>Howitzers should be no more than 50m apart and preferably in star formation for 6400-mil capability and defense of position.</p> <p>The firing position should allow for a pickup and/or LZ.</p>	<p>High angle fires may be required.</p> <p>Indirect fire data should be determined to cover dead space and avenues of approach to the fire base and to target likely enemy mortar positions and/or assembly areas around the fire base.</p> <p>XO's minimum quadrant elevation should be determined for eight sectors of fire.</p> <p>Units may have to provide their own perimeter illumination. If using a star formation, the center howitzer can perform this mission while other howitzers are engaging in direct fire.</p> <p>Infantry support may be available for defense of the fire base.</p> <p>Patrols should extend to the range of enemy mortars.</p>	<p>Cover is a primary concern.</p> <p>A strong defensive perimeter is essential.</p> <p>A small-arms cache should be placed in the center of the battery in case the position is overrun.</p> <p>Engineer support should be obtained to harden individual howitzer firing positions. As a minimum, each position should have—</p> <ul style="list-style-type: none"> ● Covered ammunition racks. ● A personnel bunker. ● Direct fire sector with a fighting trench. ● Two covered ready racks. <p>Fire bases should be mutually supporting.</p> <p>If possible, firing batteries should target dead space around positions with "killer junior." This is in addition to grenade launcher/ automatic grenade launcher based indirect fire that can be delivered by cannon and noncannon batteries.</p>	<p>Use wire extensively; bury at least 12 inches.</p>

APPENDIX A. ADVANCED FIELD ARTILLERY TACTICAL DATA SYSTEM

Development

AFATDS allows the MCFSS stations to transition to a single software system that will eventually replace existing systems.

AFATDS is one of five systems that compose the Army Tactical Command and Control System (ATCCS). AFATDS, the only jointly developed system, provides fire support planning and execution software.

With further software development, currently fielded devices will be compatible with AFATDS via variable message format protocol. When AFATDS fielding is complete, all IFSAS and tactical fire devices will be replaced. All artillery technical fire direction for cannon and rocket systems will be computed by AFATDS.

AFATDS software is developed as a fire support tool. The computer is provided with detailed guidance derived from the staff planning process and the D3A targeting methodology. This guidance provides AFATDS with “rules” to use during processing of fire support missions.

Through this process, the commander and staff determine the appropriate responses during the period of staff planning. These decisions are executed rapidly by AFATDS during intense activity that characterizes modern maneuver warfighting. Failure to provide adequate preplanned guidance will prevent the system from executing according to commander’s intent.

Guidance Management

Incoming fire missions and fire plan targets are validated by guidance entered at each fire support and fire direction echelon. For rapid and efficient attack of targets and fire plan scheduling, this guidance data must be managed.

The following guidance windows must be maintained to manage the fire support system:

- Target selection standards.
- HVT list.
- Target management matrix.
- Mission prioritization.
- System tasks.
- Fire support attack parameters.
- Munitions restrictions.

The responsibility for creating and disseminating guidance is an intrinsic element of command and thus resides with the force commander.

Before establishing the landing force ashore, the MAGTF FFC receives guidance from the amphibious force commander. This guidance is transmitted to the supporting arms coordination center, subordinate FSCCs, and fire support assets controlled by the MAGTF FFCC.

After establishing the landing force ashore, the GCE FSCC modifies guidance in accordance with the commander, landing force and GCE commander’s intent, orders, and verbal direction. This guidance is transmitted to the SACC (afloat) and subordinate FSCCs, FDCs, and fire support assets. Changes to guidance should not be disseminated between echelons as each echelon optimizes

its guidance based on its mission and role. AFATDS performs functions based on its established echelon (regiment or battalion) and role (FSCC, FDC or other).

Fire Mission Processing

Fire mission processing is a key function of the fire support system. AFATDS uses commander's guidance, task organization, and received mission information to select the appropriate fire support asset, and to route the fire mission to the appropriate operational facility (OPFAC). Processing through multiple OPFACs is usually required to move the mission from the requester to the shooter. Processing and route may be transparent to some of the OPFACs depending on intervention criteria.

Intervention Criteria

AFATDS can use database information to automatically process, coordinate, and possibly deny fire missions without operator intervention. Intervention points allow operators to stop automatic processing under given conditions to review and alter. Intervention criteria are comprised of a set of rules that govern the interruption of the automatic fire mission process. An unlimited number of intervention rules can be established, however, development and use of intervention points can significantly decrease responsiveness. Each rule is built around the following categories of mission information:

- Battle area.
- Attack option.
- Mission precedence.
- Target type.
- Filters.
- Analysis result.

These six criteria may be set in any combination to create a single rule. Multiple rules may be constructed.

Default Setup

When the database is initially constructed, a single default rule is incorporated that causes all fire missions to be subject to intervention. Deleting this rule causes all fire missions to process automatically. Missions assigned for attack by Army Tactical Missile Systems are automatically displayed for operator intervention without regard to operator-established intervention criteria.

Tracking Fire Missions

When a fire mission is processed without any intervention, each OPFAC can maintain situational awareness of active missions as described below.

Active fire missions can be displayed on an overlay, causing any received fire mission— regardless of intervention criteria—to appear on the screen as a bold target symbol. The operator can ascertain information about the target by clicking the symbol that appears.

All fire missions received are placed in the active target list until the missions end by receipt of a mission-fired report. The operator can display mission information at any time for any target.

Each method allows the operator to display the target status window that shows all fire mission messages received or transmitted for the mission in question. The status of the mission can also be requested or traced to obtain the status of the mission at every station involved.

Fire requests and fire orders may be printed when they are received and/or transmitted. This is accomplished by making entries in the configuration printing setup. This function is accessed by

selecting alerts and messages, messages, and configure printing setup.

Operational Facility Intervention

The following centers are recommended for employment of intervention criteria.

Battalion Fire Support Coordination Center

- Denied missions.
- Air and NSFS missions if these assets are available to the battalion FSCC.

Regiment Fire Support Coordination Center

- Denied missions.
- Any other rules dictated by the FSC.
- Air and naval surface fire support (NSFS) missions if these assets are available to the regiment FSCC.

Division Fire Support Coordination Center

- Denied missions.
- All fire missions in the rear operations area.
- All fire missions in the deep operations area.
- All air missions.

Battalion Fire Direction Center

All fire missions.

Regiment Fire Direction Center

All fire missions.

Attack Analysis

During attack analysis, AFATDS considers various parameters of a given fire mission; e.g.,

mission type, observer request or target location; the guidance that is in effect; the allocated attack units available; FSCMs; and attack option ranking criteria to develop attack options to achieve defeat criteria of the target. The three levels of attack analysis in AFATDS are fire support system, unit, and detailed.

Fire Support System

System attack analysis allows an FSCC to perform attack analysis only to the level of detail needed to select a fire support system and transmit the mission to the appropriate agency for further processing. When performing fire support system attack analysis, no detailed information (locations of firing units, munitions status, etc.) is required. To use fire support system attack analysis correctly, the fire support attack parameters window must be filled out. Generally, this level of attack analysis will be used only at the higher level FSCCs, such as the FFCC.

Unit

Unit attack analysis allows an OPFAC to conduct more detailed attack analysis using “rollup” unit information. This level of attack analysis would normally be used in higher level artillery FDCs/field artillery CPs. Fire units directly supporting or commanded by the OPFAC performing the analysis are analyzed using unit data (location, munitions capabilities, operational status, etc.) to determine if they can attack the target. Firing units with an intermediate FDC between them and the OPFAC are not analyzed in detail. They are analyzed using the “rollup” data contained in the unit subordinate information window. For unit attack analysis to be used correctly, the status for subordinate units must have been transmitted to the OPFAC.

Detailed

Detailed attack analysis allows an OPFAC to determine and evaluate all individual fire units (as well as collective groupings of fire units for massing) against a given target. It uses all unit data (munitions, operational status, location, etc.) to determine a solution for the target. This method is available for all OPFACs, but is generally used at the lower echelon; e.g., regiment and below, FDCs, and FSCCs.

Fire Mission Routing

Fire missions are routed through OPFACs to select the optimum fire support asset, provide a conduit for coordination, and increase situational awareness. Routing of the mission depends on the source; however, the central hub of fire support is the FSCC.

Options

AFATDS classifies a selected fire support asset as a capable engagement option into four categories:

- **Green**—the asset is a capable option and no coordination is required.
- **Yellow**—the asset is a capable option but coordination is required.
- **Red**—attack options exist but there are restrictions that prevent that asset from being capable of firing the mission.
- **Black**—no attack options exist for that FS system; i.e., the unit does not have any firing units in support.

By opening the attack options window from the menu bar of the mission window, the restrictions of a red option are shown. A series of icons

(ammunition, range, achievable effects, etc.) will show if each passed or failed.

Battalion Fire Support Coordination Center

Fire missions requested by an artillery or mortar observer are transmitted to the battalion FSCC. The observer unit information must indicate to the battalion FSCC that the observer reports to the command and supported unit (command unit identification [ID] and supported unit ID in the general unit information window for the observer). The battalion FSCC normally possesses only organic mortars to engage the target. Regardless, the battalion FSCC computer will consider only those fire support assets that are commanded by or support the battalion FSCC. If the mission is recommended for denial or processing to an air or NSFS asset, the mission appears in the intervention window and remains there until the operator takes action. If the battalion's organic mortars cannot adequately service the target, then artillery, air, and NSFS may be selected. (Selection occurs when air and NSFS are held at a higher FSCC.) These missions are transmitted to the regiment FSCC because the battalion FSCC has entered the regiment FSCC name in the fields of the system attack parameters window as the agency to route missions. The mission may be resolved in many ways as described in the following paragraphs.

Coordination Requests

Coordination requests are transmitted to the agencies responsible for violated boundaries or FSCMs. The transmitting computer will wait until the mission is approved to transmit the fire request to the regiment FSCC.

Mission Denied

The mission may be denied either by failures of guidance or denial from an agency from which

coordination was requested. The operator at the battalion FSCC may reprocess the mission.

Missions Not Requiring Coordination

Missions are transmitted to the regiment FSCC.

Missions Requiring Coordination with Electronic Warfare Assets

Missions requiring coordination with EW assets (as indicated by guidance) will transmit a request for coordination to the intelligence and EW agency listed in the mission routing info window. Denial or approval will process the mission as if coordination from another FSCC was required.

No Solution

If AFATDS is unable to determine a solution, it recommends “Denied, no capable option.” The operator can select “unsupported” causing the mission to be transmitted to the regiment FSCC (the battalion’s support unit ID) for reevaluation of fire support engagement.

Override

The operator can override AFATDS’ solution and transmit any solution to any station. Overriding and transmitting a red option does not allow the automatic routing of FO commands.

Regiment Fire Support Coordination Center

The regiment FSCC processes the mission and intervenes only on denied missions. The mission may not be assigned to the same asset as predicted by the battalion FSCC if the guidance at the regiment differs from those at the battalion. The mission may be—

- **Transmitted to any fire support asset that the regiment FSCC commands.** If additional coordination is required, requests are routed before transmitting the mission to the fire support asset.

- **Determined unsupported.** The operator can then transmit the mission—due to supported unit ID—to the division FSCC.
- **Overridden.** The operator can override the computer solution and transmit any solution to any station.

Battalion Fire Direction Center

The battalion FDC processes the mission to subordinate battery FDCs. The battalion FDC will perform detailed attack analysis due to software default. Fire missions will never be denied at the battalion FDC. Though several options may be available, the battalion FDC will select one of the following solutions:

- The fire mission can be passed to the firing units selected by AFATDS.
- The fire mission can be transmitted to any subordinate or reinforcing unit regardless of the option AFATDS selected.
- The mission can be returned to the regiment FSCC as “unsupported.” This option should not be required if the regiment FSCC is in detailed attack analysis. However, if “unsupported” is selected, the mission is returned to the regiment FSCC, reprocessed, and most likely transmitted to the division FSCC as “unsupported.” This is AFATDS’ method of “request for reinforcing fires.” Since the fire mission may be received again by the battalion FDC as part of a massed fire mission solution from the regiment FDC, any mission returned to the regiment FDC as “unsupported” is immediately manually deleted from the active fire target list by the battalion FDC.

Division Fire Support Coordination Center

The division FSCC processes fire missions received but seldom intervenes. NSFS missions are printed and handed off to the representative of this asset (unless automated communications are available to these units). Artillery missions are

passed to the regiment FDC for processing. Air missions are transmitted to the DASC.

Regiment Fire Direction Center

The regiment FDC processes received fire missions using detailed attack analysis. Fire orders are passed to subordinate battalion FDCs. If the mission is unsupportable, it is returned as an “unsupportable” mission to the division FSCC. The regiment FDC does not deny the mission.

Radar Fire Mission and the Target Processing Center

Radars held in GS are controlled by the TPC. The TPC will process all fire missions to the regiment

FDC by clicking “unsupportable.” Since the TPC is commanded by the regiment FDC, missions are automatically passed there.

All radar fire missions require coordination since they will plot in the zone of a maneuver unit. Coordination is normally effected by coordination requests automatically generated at the regiment FDC, not at the TPC. “Unsupportable” missions do not require coordination until an attack option is determined.

Radars in DS of a battalion are directly linked to that FDC. Command and support relationships of these radars are changed to reflect this, and the fire missions transmitted are processed by the battalion FDC in the same fashion as fire missions received by an FO.

APPENDIX B

ARTILLERY WEAPONS AND MUNITIONS

Separate-Loading Ammunition

Separate-loading ammunition is issued as four separate components: primer, propellant, projectile, and fuze. Components are unpacked, prepared for firing, and loaded into the weapon in three portions: the projectile with fuze, the propellant, and the primer.

155 Millimeter Shell-Fuze Combinations

High Explosive Shell (M107), Point Detonating Fuze (M557 and M739)

This bursting-type projectile is filled with trinitrotoluene (TNT) or composition B. It produces fragmentation and blast over a wide area on impact. Optimum effectiveness is gained by using the lowest charge without causing excessive dispersion. M557 fuzes are subject to premature detonation by heavy rain or hail. This combination is used against standing personnel, unarmored vehicles, and light material. It is particularly effective in high angle fire. Effectiveness is reduced on dug-in personnel, on uneven ground, and against buildings or earthworks.

High Explosive Shell, Delay Fuze

This function is obtained by rotating a set screw on the point detonating (PD) fuze to cause a .05 second delay in detonation after impact. This shell-fuze combination penetrates overhead cover or obtains airburst by ricochet. The highest practical charge is used for ricochet effect. High explosive (HE) delay is effective against unarmored vehicles, earth and

log fortifications, some masonry and concrete targets, personnel in light frame structures, lightly covered emplacements, and dense woods. It is not effective against heavy masonry or concrete.

High Explosive Shell, Proximity Fuze (M728 and M732)

The variable time (VT) fuze has a nonadjustable, radio-activated HOB of 7 meters above the target. The fuze functions when it receives the reflection of a self-transmitted radio signal. A wet or marshy target area causes a greater reflection and increases the HOB. The increased angle of fall results in the fuze functioning closer to the ground. When the target is close to friendly troops, the lowest practical charge for a large angle of fall is used. This shell-fuze combination is useful where an airburst is desired without the need to adjust the HOB. It is particularly useful when engaging targets at long-range, at night, and for high angle fire. Light foliage has little effect on the VT fuze, but heavy foliage will cause it to function early.

High Explosive Shell, Mechanical Time Super Quick Fuze (M564, M577, and M582)

This fuze contains a graduated time mechanism set before firing to activate at a predetermined time interval. The HOB is normally set to activate 20 meters above the target or on impact. However, the HOB will usually require adjustment. It is unreliable in high angle fire because of a large probable error (PE) in HOB. The highest practical charge is used to minimize the HOB error. M564 fuzes are subject to premature detonation by heavy rain or hail. This shell-fuze combination is effective against exposed personnel or personnel in uncovered trenches or fighting positions.

High Explosive Shell, Delay (Concrete Piercing) Fuze (MK399 Mod 1 Series)

This fuze can be set for PD or delay. In PD mode, the fuze functions as a standard supercargo fuze. In the delay mode, it penetrates for 4 to 9 milliseconds before functioning. This combination is used against urban targets to reduce rubble.

White Phosphorus Shell (M110 Series)

This burster-type projectile is filled with white phosphorus (WP). On detonation, WP is expelled over a limited area. It is usually fuzed with PD fuzes M557 or M739. However, it can be fuzed with mechanical time (MT) fuzes M564 or M582 to produce an airburst. WP is used for marking, screening, obscuring, and incendiary effects. It is effective against vehicles, POL storage areas, etc.

Smoke Shells (M116 Series and M825)

Smoke shells are an expelling charge type projectile that contain canisters filled with a pyrotechnic smoke mixture. When an MT fuze (M564 or M577) activates, these canisters expel from the rear of the projectile, producing smoke for 60 to 90 seconds. The projectile usually requires adjustment. The smoke has a greater screening effect than WP, but requires more time to build up. The hexachloroethane (artillery smoke) (HC) smoke projectile is being replaced with the M825 improved smoke round. The M825 uses felt wedges impregnated with WP for rapid dissemination and provides 5 to 10 minutes of smoke. An MT fuze activates a charge causing base ejection and ignition of the WP felt wedges in a large area. As unburned WP can cause a hazard to friendly forces, caution must be exercised when operating in these areas.

Illuminating Shell (M485)

Illumination is an expelling charge-type projectile that contains an illuminant canister and parachute assembly. When the MT fuze functions (M564 or M577), the canister/parachute assembly expels

from the base of the projectile, and the illuminant suspends from the parachute providing 1,000,000 candle power of battlefield illumination.

Improved Conventional Munitions (M449 and M483A1)

This expelling charge-type projectile contains submunitions (grenades). When an MT fuze (M564 or M577) or an electronic time fuze (M762) functions, the grenades eject over the target area. The two types of ICM are antipersonnel improved conventional munition (APICM) and dual purpose improved conventional munition (DPICM).

APICM contains 60 grenades. When the grenade strikes the target, it hurls a ball-like grenade 5 to 6 feet into the air, where it detonates and scatters over the target area. APICM has maximum effectiveness against troops in the open. Some effect can be gained on troops in fighting positions.

DPICM contains 88 dual-purpose armor defeating and antipersonnel grenades. When the projectile detonates, an HE shaped-charge grenade suspended from a ribbon streamer expels. On impact, a shaped-charge jet expels downward through the body of the grenade, while the rest of the grenade bursts outward producing fragmentation. The jet penetrates approximately 2.75 inches of homogenous armor plate. DPICMs are effective against vehicles such as armored personnel carriers and trucks. Minimal effects are produced against hard materiel targets.

The effects pattern of ICM is generally uniform and circular. Pattern size varies with the caliber, characteristics of the target area, and the HOB. Six 155-millimeter howitzers can deliver an effects pattern of 150 meters in radius. The HOB may require adjustment. Deep snow (over 6 inches) can reduce the effects by more than 50 percent. All ICM grenades are subject to duds. At the optimum HOB, the dud rate is normally less than 2 percent; on some types of terrain, it may be as high as 15 percent. ICM are more effective than HE on area personnel

targets because a greater area is uniformly covered with a greater density of fragmentation. Caution should be exercised when firing DPICMs in trees because the ribbon streamers hang in the trees, creating obstacles to friendly troops moving in the area.

High Explosive, Rocket-Assisted Projectile (M549 Series)

Rocket-assisted projectiles (RAPs) have high fragmentation steel cases filled with composition B or TNT. An integral rocket motor is positioned on the rear that functions along the trajectory, increasing the range of the projectile. RAP accuracy is reduced at longer ranges due to the uneven burn of the rocket motor. However, the RAP will produce more fragmentation over a larger area than the standard HE projectile. The RAP can be fuzed with PD fuze (M557 or M739), MT fuze (M582 series), VT (M732A2) or electronic time fuze (M767). This combination is used on targets similar to those for the HE shell M107.

Cannon-Launched Guided Projectile (or Copperhead)

The cannon-launched guided projectile (CLGP) (or Copperhead) is an antitank round that can home in on its target after being fired. It is employed in indirect fire to destroy or neutralize moving and stationary hard point targets such as armor, mechanized vehicles or field fortifications. Targets must be designated during the latter phase of the terminal portion of the trajectory for at least 13 seconds by a ground or airborne laser that provides reflective laser energy for terminal homing.

Family of Scatterable Mines (M731 [S], M692 [L], M741 [S], and M718 [L])

FASCAM refers to expelling charge projectiles used to deliver antitank or antipersonnel mines. FASCAM includes area denial artillery munitions

(ADAM) and remote antiarmor mine system (RAAMS). These projectiles are fuzed with a mechanical time super quick fuze (M577) or an electronic fuze (M762).

ADAM projectiles are antipersonnel projectiles that contain submunitions to deny the threat use of certain areas for a short period. Upon fuze function, the ADAM ejects 36 submunitions per projectile over the target area. After each submunition comes to rest on the ground, seven sensor trip lines will deploy up to 20 feet from each mine. Disturbing the trip line activates the kill mechanism and projects upward. At approximately 2 to 8 feet above the ground, the kill mechanism detonates, projecting approximately 600 steel fragments in all directions. If the mine has not detonated or functioned within the factory set time—48 hours (long) or 4 hours (short)—it will automatically self-destruct and clear the area.

RAAMS projectiles are antitank projectiles that contain submunitions to deny or delay access to a particular area for a specific period. Each projectile contains nine mines that expel into the target area. Mines scatter over an area and become armed within seconds after landing. Metallic objects, such as tanks, self-propelled vehicles or other type units, passing over the mines will activate them and damage or destroy equipment. These mines also have self-destruct mechanisms. Mines that have an antidisturbance firing mechanism are randomly scattered through the group to reduce tampering. *When firing a shell-mix of ADAMS and RAAMS, the RAAMS is fired first to prevent the premature detonation of ADAMS.*

Propellants

M3 Series Propelling Charge (Green Bag)

Green bag propellant is used to fire charges 1 through 5. The M3 series contains M3 and M3A1 propellants.

M4 Series Propelling Charge (White Bag)

White bag propellant is used to fire charges 3 through 7. The M4 series contains M4A1 and M4A2 propellants.

M119 Series Propelling Charge

M119A1 is a propelling charge designated as charge 8 and extends the range of the 155-millimeter howitzers using the M795 HE projectile. The propelling charge is a single-increment white bag charge. M119A1 has a donut-shaped flash reducer at the forward end that precludes non-ignition of the rocket motor of the RAP.

M119A2 is a charge 7 red bag propellant. The propelling charge is a single increment red bag charge.

M203 Series Propelling Charge

The M203 and M203A1 are the super charge 8 that supplement the standard M3, M4, and M119 series charges and provide extended range. The M203 is a single increment red bag charge. The M203A1 is a single increment stick propellant charge in a cardboard sleeve. Both charges are used interchangeably to fire RAP, M795, M864 base-burn dual purpose improved conventional munition (BBDPICM) or M825A1.

Ammunition Field Storage

The four greatest hazards to ammunition in the battery area are weather, threat fire, improper handling, and careless smokers. Regardless of how ammunition is stored, these hazards must be considered. See MCWP 3-16.3.

Procedures for Burning Powder

- Select a burning site at least 200 meters from grass, loose debris, personnel, and equipment.

- Arrange a row of increments in a single layer not more than 12 inches wide oriented in the direction of the wind.
- Lay a train of combustible material about 15 feet long, perpendicular to and at the downwind end of the row of charge increments. Light this train at the end farthest from the increments.
- When burning powder in a tactical environment, ensure the burning does not compromise the camouflage and concealment effort.

Ammunition Under Development

Several munitions are under development for artillery weapons systems. This following information focuses on those relevant to the 155-millimeter towed howitzer systems (XM777 and M198).

M795, High Explosive Projectile

The M795 is a 155-millimeter HE projectile. It will be employed against the same target array as the M107 HE projectile and achieve a range of 22.5 kilometers. It will be used to determine registration corrections for expeditious computation of range, deflection, and fuze setting corrections for other members of the M483 family of projectiles.

Extended Range M795

The extended range M795 possesses similar ballistic characteristics as the M864 BBDPICM projectile and will have a greater lethality at extended ranges than the M549 HE rocket assisted projectile. When fired with zone 5, modular artillery charge system (MACS), it will achieve a range of 37 kilometers (threshold) to 40 kilometers (objective). This projectile will determine registration corrections for expeditious computation of range, deflection, and fuze setting corrections for use with the M864 BBDPICM projectile.

XM982 Extended Range Munitions

The XM982 extended range projectile will replace the M864 BBDPICM projectile and will provide 155-millimeter howitzers with an extended range, fratricide reducing, accuracy-enhancing capability to the FMF. The XM982 concept combines drag reduction from the M864 BBDPICM projectile and glide technology from the M712 Copperhead projectile. The three variants of the XM982 are the DPICM, sense and destroy armor munition (SADARM), and Unitary Warhead. Each has a GPS/inertial navigation system self-location system, is compatible with the multioption fuze for artillery, and will be inductively set via the portable inductive artillery fuze setter (PIAFS).

Sense and Destroy Armor Munition

The SADARM is a base-ejecting projectile that carries two submunitions. When ejected, these submunitions detect armored vehicles or equipment and detonate an explosively formed penetrator to penetrate the top of the target. SADARM is ballistically similar to the M483A1 and will determine registration corrections for expeditious computation of range, deflection, and fuze setting corrections for use with the M483A1. SADARM will be capable of a 28 to 37 kilometer range from a 39 caliber cannon and maintain an effectiveness equal to or greater than that of the M864 BBDPICM projectile.

M782 Multioption Fuze for Artillery

The MOFA fuze is compatible with all 155-millimeter HE family projectiles. It may function as a proximity, time, PD or delay fuze. It consists of an

electronic countermeasure hardened design and will be set inductively via the PIAFS.

Portable Inductive Artillery Fuze Setter

PIAFS will initially be a battery-powered, hand held device capable of electronically setting the M762, M767, and MOFA fuzes. This will increase accuracy and rates of fire, reduce human errors, and shorten artillery response time. Ultimately the PIAFS is envisioned to become incorporated into the pre-planned program improvement (P3I) system of the XM777 howitzer by transferring fuze information directly from the technical solution derived by the P3I mission manager to the fuze.

Modular Artillery Charge System

MACS consists of two solid propellant charges (M231 and M232) that will be compatible with all 155-millimeter artillery systems. The M232 is designed solely for the United States Army's Crusader Self-Propelled howitzer. Charge errors will be reduced due to each charge being identical; i.e., rather than verifying the correct number of increments and the correct charges, only the correct number of increments has to be verified. MACS will also reduce logistical requirements because of its reduced volume and weight compared to the M3A1 green bag and M4A2 white bag series of propellants.

Miscellaneous

Tables B-1 through B-4 are not prescriptive; they are planning examples.

Table B-1. Fuzes.

Type	Current	DODIC	Replacement	DODIC	Future
Concrete Piercing Delay Concrete Piercing Nondelay	M78A1 M78A1	N330 N331	None None	NA NA	Mk 300 Mod 1 DODIC 659
Point Detonating Super Quick or Delay Super Quick or Delay	M557 M572	N335 N331	M739 M739	N340 N340	Multioption Fuze for Artillery " " " "
Mechanical Time	M565	N248	M577*	N285	M762
Mechanical Time Super Quick	M564	N278	M582*	N286	M767, Multioption Fuze for Artillery
Variable Time	M728	N463	M732	N464	Multioption Fuze for Artillery

NOTE: Fuze DODAC = 1390 plus DODIC number as shown above.
*M577 and M582 can be set for mechanical time or super quick action. There is not a point detonating backup on these fuzes.

Table B-2. Characteristics of Selected Artillery Weapons.

Weapon	XM777	M198	M109A3/A4 ¹	M109A5/A6 ¹
Weight (pounds)	9,000	16,000	53,940	64,000
Time to Emplace (minutes)	3 or less	4	0.5	0
Transport Capability				
Ground	MTRV, 5-ton	5-ton	Self-propelled	Self-propelled
Helicopter	V-22, CH-53E, CH-53D	CH-53E	No	
Fixed-Wing Transport	All	All	C-5A	
Maximum Rate of Fire Per Tube (rounds per minute)	5-8	4	4	
Sustained Rate of Fire Per Tube (rounds per minute)	2 ²	2 ²	1	4
High Explosive				
Effective Casualty Radius (1 round)	50m	50m	50m	50m
Weight of Projectile (fuzed) (pounds)	95 ⁴	95 ⁴	95 ⁴	95 ⁴
Traverse (mils)	6400 ³	6400 ³	6400	6400
Maximum Speed (miles per hour)				
Towing - Cross Country	24 kph	5	NA	NA
Towing - Secondary Roads	56 kph	25-30	NA	NA
Towing - Improved Roads	88 kph	45	NA	NA
Self-Propelled Speed	NA	NA	35	38
Cruising Range (miles)	NA	NA	220	185

¹ US Army units with these systems may be attached or placed under operational control to Marine units.
² Two rounds per minute or as determined by thermal warning device.
³ 6400 mils traverse using speed shift; 400 mils left/right without speed shift.
⁴ 95 pounds for M107 Family; 103.5 pounds for M483 Family; 137.6 pounds for Copperhead.

Table B-3. Projectiles and Propelling Charges (M198/M109A5/A6).

Propelling Charges							
PROJECTILES	DODAC	M3 SERIES	M4 SERIES	M119 SERIES	M203	MAXIMUM RANGE (METERS)	FUZE ACTIONS
M107 HE	1320-D544	Yes, but not zone 1 or 2	Yes	Yes	No	18,100	Concrete piercing, point detonating, mechanical time super quick, variable time, electronic time
M549A1 RAP	1320-D579	No	Yes, but zone 7 only	Yes, but not M119	Yes	30,000	Point detonating, electronic time
M449A1 ICM	1320-D562	Yes, but not zone 1 or 2	Yes	Yes	No	18,100	Mechanical time, electronic time, mechanical time super quick
M485 Illum	1320-D505	Yes, but not zone 1	Yes	Yes, but degraded reliability	No	18,100	Mechanical time, electronic time, mechanical time super quick
M483A1 DPICM	1320-D563	Yes, but not zone 1 or 2	Yes	Yes	No	17,740	Mechanical time, electronic time, mechanical time super quick
M864 BB DPICM	1320-D864	No	Yes	Yes	Yes	28,180 (M198) 27,740 (M109A5/A6)	Mechanical time super quick, M577, electronic time
M692 ADAM-L	1320-D501	Yes, but not zone 1 or 2	Yes	Yes	No	17,740	Mechanical time, electronic time
M731 ADAM-S	1320-D502	Yes, but not zone 1 or 2	Yes	Yes	No	17,740	Mechanical time, electronic time
M116A1 HC	1320-D506	Yes, but not zone 1 or 2	Yes	Yes	No	18,100	Mechanical time, electronic time
M110A1 WP	1320-D550	Yes, but not zone 1 or 2	Yes	Yes	No	18,100	Point detonating, mechanical time super quick
M795 HE	1320-D529	Yes, but not zone 1 or 2	Yes	Yes	Yes	22,500	Point detonating, mechanical time super quick (M732 variable time only)
M825 Smoke	1320-D528	Yes, but not zone 1 or 2	Yes	Yes	No	18,100	Mechanical time, electronic time
M718 RAAMS-L	1320-D503	Yes, but not zone 1 or 2	Yes	Yes	No	17,740	Mechanical time, electronic time
M741 RAAMS-S	1320-D509	Yes, but not zone 1 or 2	Yes	Yes	No	17,740	Mechanical time, electronic time
M804 Practice	1320-D513	Yes, but not zone 1 or 2	Yes	Yes	No	18,100	Point detonating, mechanical time super quick, (variable time M732 only), electronic time

Table B-4. Projectiles and Propelling Charges (M109A2/A3/A4).

Propelling Charges							
PROJECTILES	DODAC	M3 SERIES	M4 SERIES	M119 SERIES	M203	MAXIMUM RANGE (METERS)	FUZE ACTIONS
M107 HE	1320-D544	Yes, but not zone 1	Yes	Yes	No	18,100	Concrete piercing, point detonating, mechanical time super quick, variable time
M549A1 RAP	1320-D579	No	Yes, but zone 7 only	Yes, but not M119	Yes	23,500	Point detonating
M449A1 ICM	1320-D562	Yes, but not zone 1	Yes	Yes	No	18,100	Mechanical time
M485 Illum	1320-D505	Yes, but not zone 1	Yes	Yes, but degraded reliability	No	17,500	Mechanical time
M483A1 DPICM	1320-D563	Yes, but not zone 1 or 2	Yes	Yes	No	17,500	Mechanical time
M864 BB DPICM	1320-D864	No	Yes	Yes	Yes	22,000	Mechanical time super quick M577
M692 ADAM-L	1320-D501	Yes, but not zone 1 or 2	Yes	Yes	No	17,740	Mechanical time
M731 ADAM-S	1320-D502	Yes, but not zone 1 or 2	Yes	Yes	No	17,740	Mechanical time
M116A1 HC	1320-D506	Yes, but not zone 1	Yes	Yes	No	18,100	Mechanical time
M110A1 WP	1320-D550	Yes, but not zone 1	Yes	Yes	No	18,100	Point detonating, mechanical time super quick
M795 HE	1320-D529	Yes, but not zone 1 or 2	Yes	Yes	Yes	22,500	Point detonating, mechanical time super quick (M732 variable time only)
M825 Smoke	1320-D528	Yes, but not zone 1 or 2	Yes	Yes	No	17,500	Mechanical time
M718 RAAMS-L	1320-D503	Yes, but not zone 1 or 2	Yes	Yes	No	17,740	Mechanical time
M741 RAAMS-S	1320-D509	Yes, but not zone 1 or 2	Yes	Yes	No	17,740	Mechanical time
M804 Practice	1320-D513	Yes, but not zone 1	Yes	Yes	No	18,100	Point detonating, mechanical time super quick (variable time M732 only)

Fire Support Coordinating Measures	
TYPE	IN EFFECT AND DESCRIPTION
FSCM	
CFL	
RFA(s)	
NFA(s)	
RFL(s)	
FEBA	

<p>Changes to Attack Guidance</p> <hr/> <hr/> <hr/> <hr/> <hr/>
<p>Future Plans</p> <p>Movements</p> <hr/> <hr/> <hr/> <hr/> <hr/>
<p>Frag/Warning Orders</p> <hr/> <hr/> <hr/> <hr/> <hr/>
<p>Other</p> <hr/> <hr/> <hr/> <hr/> <hr/>
<p>Employment of CBR, Met, and Survey</p> <p>CBR</p> <hr/> <hr/> <hr/> <hr/> <hr/>
<p>Met</p> <hr/> <hr/> <hr/> <hr/> <hr/>
<p>Survey</p> <hr/> <hr/> <hr/> <hr/> <hr/>
<p>Last Target Number _____</p>
<p>Anticipated Changes (Commander's Intent)</p> <hr/> <hr/> <hr/> <hr/> <hr/>

APPENDIX D

REPORTS

Title: Fire Capabilities (FIRECAP) Report	
Purpose: To report artillery battery in position and ready to fire or to report a change in the number of weapons available.	
Occasion: When the battery is ready to fire or when a change occurs in the number of weapons functioning.	
ELEMENT	INFORMATION
Type of Report	FIRECAP
Line A	Unit (call sign)
Line B	Grid (encoded)
Line C	Azimuth of fire (in mils and encoded)
Line D	Number of weapons (encoded)
NOTE: Use only applicable lines.	

Figure D-1. Fire Capabilities Report (FIRECAP).

Title: Displacement Report (DISREP)	
Purpose: To report displacement of artillery battery.	
Occasion: When unit displaces; i.e., can no longer fire.	
ELEMENT	INFORMATION
Type of Report	DISREP
Line A	Unit
Line B	Time
Line C	Destination
Line D	Number of weapons
NOTE: Use only applicable lines.	

Figure D-2. Displacement Report (DISREP).

Title: Command Post Report (CPREP)	
Purpose: To report the time of opening and closing of the CP and the location of the new CP.	
Occasion: When a CP is opened and closed.	
ELEMENT	INFORMATION
Type of Report	CPREP
Line A	Unit (call sign)
Line B	Location (encoded)
Line C	Date-time group CP established
NOTE: Use only applicable lines.	

Figure D-3. Command Post Report (CPREP).

Title: Movement Order Report	
Purpose: To report route and location information.	
Occasion: When a unit moves.	
ELEMENT	INFORMATION
Type of Report	Movement Order
Line A	Grid to occupy*
Line B	Azimuth of fire*
Line C	Displace NET NLT
Line D	Occupy NET NLT
Line E	Route of march*
Line F	Method of march
Line G	Remarks
*Encrypt if transmitted in the clear.	

Figure D-4. Movement Order Report.

Title: Situation Report	
Purpose: To provide information to other units.	
Occasion: As the tactical situation requires.	
ELEMENT	INFORMATION
Type of Report	SITREP
Line A	Unit (call sign)
Line B	DTG
Line C	Location*
Line D	Number of weapons
Line E	Number of weapons up
Line F	Number of rounds fired since last SITREP.
Line G	Significant events
Line H	Problems
Line I	Remarks
*Encrypt if transmitted in the clear.	

Figure D-5. Situation Report (SITREP).

Title: Rapid Request	
Purpose: To provide units with a means to submit a rapid request.	
Occasion: When a unit has a rapid request.	
ELEMENT	INFORMATION
Type of Report	Rapid Request
Line A	From (call sign)
Line B	To (call sign)
Line C	DTG
Line D	Grid location*
Line E	Priority (urgent, priority, routine)
Line F	Support required and remarks
Line G	Point of contact
*Encrypt if transmitted in the clear.	

Figure D-6. Rapid Request.

(1) SECTION:		(2) LOCATION:				
(3) SEARCH ZONES		LEFT	RIGHT	MIN	MAX	
(a) PRIMARY		(1)	(2)	(3)	(4)	
(b) ALTERNATE		(1)	(2)	(3)	(4)	
(4) EMISSION LIMITS	(a) TIME			(b) TGTS		
(5) CUEING AGENCY	(a)		(b)		(c)	
(By call sign, in order of priority)	(d)		(e)		(f)	
(6) REPORTING CHANNELS	(a)			(b)		
(7) STATUS	(a) UP:		(b) DOWN:		(c) MOVING:	
(8) ZONES/GRID POINTS						
	(1)	(2)	(3)	(4)	(5)	(6)
(a)						
(b)						

Figure D-7. Radar Report.

Title: FLASHREP/SPOTREP/TAREP and Follow-Up Reports	
Purpose: Target reports (TAREPs) are used to pass target data.	
Occasion: When potential target is discovered or after attack of significant target or target on target list.	
ELEMENT	INFORMATION
Type of Report	SPOTREP
Line A	Precedence: Flash/Immediate/Priority/Routine
Line B	Reporting Unit
	Time:
	DTG of Report
	DTG of Incident
Line C	Reference: Original SPOTREP DTG or Target Number
Line D	Location:
	Enemy
Line E	Friendly
	Incident Description:
	Target Description
	Vulnerability
	Accuracy of Location (In Meters)
	Size, Shape, and Orientation (In Meters and Mils)
Line F	Associated/Equipment or Units
Line G	Action Taken:
	Friendly Casualties:
	KIA
	WIA
Line H	MIA
	Enemy Casualties:
	KIA
Line I	EPW
Line J	Enemy Weapons/Equipment/Documents Captured
	Friendly Weapons/Equipment Damaged/Destroyed
Line K	Lost
Line L	Remarks
NOTE: Use only applicable lines. The group of digits must always be preceded by the block of two capitals designating the 100km square; e.g., LB6448. When reporting attack or target or result of attack, include lines C2 (DTG of incident) and E1 (location of enemy). Intelligence agencies need this information.	

Figure D-8. SPOTREP.

Title: Shelling Report (SHELLREP)	
Purpose: To report bombing, shelling or mortaring by the enemy.	
Occasion: Submitted as soon as possible after incident.	
ELEMENT	INFORMATION
Line A	Unit of origin
Line B	Position of observer
Line C	Direction in mils
Line D	Time from
Line E	Time to
Line F	Area bombed, shelled or mortared
Line G	Number and nature of guns; i.e., mortars, rockets
Line H	Nature of fire
Line I	Number, type, and caliber of weapons
Line J	Time of flash to bang
Line K	Damage
NOTE: Use only applicable lines.	

Figure D-9. Shelling Report (SHELLREP).

Title: Size, Activity, Location, Unit, Time and Equipment (SALUTE) Report.	
Purpose: To provide combat reporting.	
Occasion: As required.	
ELEMENT	INFORMATION
Line A	Size
Line B	Activities
Line C	Location
Line D	Unit
Line E	Time
Line F	Equipment
Line G	Remarks, source, evaluation, etc.
Line H	ATG
NOTE: Use only applicable lines.	

Figure D-10. Size, Activity, Location, Unit, Time, and Equipment (SALUTE) Report.

Title: Medical Evacuation (MEDEVAC)	
Purpose: To request medical evacuation.	
Occasion: As required.	
ELEMENT	INFORMATION
Line A	Emergency, priority, routine *
Line B	Requesting unit (call sign)
Line C	Pick up coordinate
Line D	Number requesting MEDEVAC**
Line E	Airborne medical assistance required
Line F	LZ secure/not secure
Line G	Best approach directions
Line H	LZ markings
Line I	LZ frequency and call sign
* Emergency—life or death threatening. Priority—serious injury, life not immediately threatened. Routine—minor injuries or dead.	
** Include number of WIA, KIA, and sick.	

Figure D-11. Medical Evacuation (MEDEVAC) Report.

APPENDIX E

LOGISTICS PLANNING DATA

Table E-1. Headquarters Battery, Artillery Regiment, Personnel.

	E1-E5	E6-E9	W1-W4	O1-O3	O4-O6	Totals
USMC	284	51	9	12	9	365
USN	5	2	0	0	3	10
Totals	289	53	9	12	12	375

Table E-2. Headquarters Battery, Artillery Regiment, Selected Major Equipment.

Item	Authorized Quantities	Embarkation Data		Cargo Capacity for Authorized Quantity		
		Ft ²	Lbs	Ft ^{3*}	Gals	Lbs
Mk48 Truck, Logistics Vehicle System	5	12,920	2,065,000			125,000
Mk48 Truck, LVS Wrecker	1	2,584	53,700			
M923 Truck, Cargo, 5-ton	57	11,856	1,304,046	26,904		570,000
M936, Truck, Wrecker, 5-ton	2	470	76,932			
M105A1 Trailer, 1½-ton	25	2,400	66,750	3,555**		75,000
M149 Trailer, Water	2	202	5,060		800	
M998 Truck, Utility	45	4,770	227,700	3,983		112,500
AN/MRC 145 Radio Set	9	954	46,800			
AN/MRC 142 Radio Set	4	424	20,800			
AN/MRC 138 Radio Set	9	954	46,800			
JOM-1 Steam Cleaner	2	70	2,200			
M101A1 Trailer	15	1,140	20,250	2,595		22,500
M1305 Truck, Ambulance	1	106	5,361			
AN/TPQ-36 Firefinder Radar	5	795	28,125			
* Cargo capacity under bows.						
** Cargo capacity to top of side racks.						

Table E-3. Headquarters Battery, Artillery Regiment, Class V Small Arms Combat Planning Rates.

DODIC/Description	Basic Allowance	Armor Heavy		Infantry Heavy		Composite	
		Assault	Sustained	Assault	Sustained	Assault	Sustained
A059/5.56mm Ball	99,050	3,771	1,119	1,734	1,084	2,796	1,100
A061/5.56mm Tracer	2,830	1,843	311	467	257	1,184	281
A064/5.56mm 4&1 Linked	0	0	0	0	0	0	0
A131/7.62mm 4&1 Linked	10,400	440	74	911	119	673	100
A363/9mm	2,700	91	71	78	73	85	72
A518/.50 Cal SLAP 4&1 Linked	2,000	154	85	34	57	94	69
A576/.50 Cal 4&1 Linked	4,000	1,765	974	386	647	1,080	787
B504/40mm Green Star Parachute	8	11	1	11	1	11	1
B505/40mm Red Star Parachute	8	11	1	11	1	11	1
B506/40mm Red Smoke	7	6	1	6	1	6	1
B508/40mm Green Smoke	13	6	1	6	1	6	1
B509/40mm Yellow Smoke	7	6	1	6	1	6	1
B535/40mm White Star Parachute	52	13	1	13	1	13	1
B542/40mm LKD	2,880	353	177	196	165	275	170
B546/40mm HEDP	468	29	30	25	31	27	30
G881/Gren Fragmentation	75	20	14	19	17	19	16
G900/Gren Incendiary	4	1	1	1	1	1	1
G940/Gren Green Smoke	12	1	1	1	1	1	1
G945/Gren Yellow Smoke	12	1	1	1	1	1	1
G950/Gren Red Smoke	12	1	1	1	1	1	1
G930/Gren HC Smoke	12	1	1	1	1	1	1
G960/Gren Violet Smoke	12	1	1	1	1	1	1
L603/Sig Red Star Cluster	9	1	1	1	1	1	1
L307/Sig White Star Cluster	9	1	1	1	1	1	1
L311/Sig Red Star Parachute	9	1	1	1	1	1	1
L312/Sig White Star Parachute	9	1	1	1	1	1	1
L314/Sig Green Star Cluster	9	1	1	1	1	1	1
L323/Sig Smk Ground RP	9	1	1	1	1	1	1
L324/Sig Smk Ground GP	9	1	1	1	1	1	1
L495/Flare Trip	8	2	1	1	2	1	2

NOTE: Rounds have been rounded up to the nearest whole figure. Ammunition figures based on the following numbers of weapons per battery: M-16 283, M9 90, M-240G 13, M-2 10, Mk-19 10, and M203 26.

Table E-4. Headquarters Battery, Artillery Battalion, Personnel.

	E1-E5	E6-E9	W1-W4	O1-O3	O4-O5	Totals
USMC	137	30	5	12	6	190
USN	3	1	0	5	0	9
Totals	140	31	5	17	6	199

Table E-5. Headquarters Battery, Artillery Battalion, Selected Major Equipment.

Items	Authorized Quantities	Embarkation Data		Cargo Capacity for Authorized Quantity		
		Ft ²	Lbs	Ft ^{3*}	Gals	Lbs
Mk48 Truck, Logistics Vehicle System	2	3,834	50,600			
Mk14 Trailer	6	4,002	96,000			150,000
M923 Truck, Cargo, 5-ton	10	2,080	228,780	4,550		100,000
M936, Truck, Wrecker, 5-ton	2	470	76,932			
M105A1 Trailer, 1½-ton	4	384	10,680	1,112		12,000
M101A3, Trailer	12	912	16,200	2,076		18,000
M149 Trailer, Water	2	202	5,060		800	
M998 Truck, Utility	18	1,908	91,080	1,422**		45,000
AN/MRC 145 Radio Set	6	636	31,200			
AN/MRC 138 Radio Set	5	530	26,750			
JOM-1 Steam Cleaner	2	70	2,200			
M1305 Truck, Ambulance	1	106	5,361			
MC 4000 Forklift	2	227	16,000			
* Cargo capacity under bows. ** Cargo capacity to top of side racks.						

**Table E-6. Headquarters Battery, Artillery Battalion, Class V Small Arms
Combat Planning Rates Composite Threat.**

DODIC/Description	Basic Allowance	Armor Heavy		Infantry Heavy		Composite	
		Assault	Sustained	Assault	Sustained	Assault	Sustained
A059/5.56mm Ball	45,850	1,745	518	803	502	1,294	509
A061/5.56mm Tracer	1,310	853	144	217	119	548	131
A064/5.56mm 4&1 Linked	6,400	1,942	441	214	371	1,105	402
A131/7.62mm 4&1 Linked	3,200	136	23	281	37	207	31
A363/9mm	1,800	61	48	53	49	57	48
A518/.50 Cal SLAP 4&1 Linked	800	62	34	14	23	38	28
A576/.50 Cal 4&1 Linked	1,600	706	390	155	259	432	315
B504/40mm Green Star Parachute	3	5	1	4	1	4	1
B505/40mm Red Star Parachute	3	5	1	4	1	4	1
B506/40mm Red Smoke	3	2	1	2	1	2	1
B508/40mm Green Smoke	5	2	1	2	1	2	1
B509/40mm Yellow Smoke	3	2	1	2	1	2	1
B535/40mm White Star Parachute	20	5	1	5	1	5	1
B542/40mm Linked	1,152	142	71	79	66	110	68
B546/40mm HEDP	180	11	12	10	12	11	12
G881/Gren Fragmentation	75	11	8	10	9	11	9
G900/Gren Incendiary	4	1	1	1	1	1	1
G940/Gren Green Smoke	12	1	1	1	1	1	1
G945/Gren Yellow Smoke	12	1	1	1	1	1	1
G950/Gren Red Smoke	12	1	1	1	1	1	1
G930/Gren HC Smoke	12	1	1	1	1	1	1
G960/Gren Violet Smoke	12	1	1	1	1	1	1
L603/Sig Red Star Cluster	9	1	1	1	1	1	1
L307/Sig White Star Cluster	9	1	1	1	1	1	1
L311/Sig Red Star Parachute	9	1	1	1	1	1	1
L312/Sig White Star Parachute	9	1	1	1	1	1	1
L314/Sig Green Star Cluster	9	1	1	1	1	1	1
L323/Sig Smk Ground RP	9	1	1	1	1	1	1
L324/Sig Smk Ground GP	9	1	1	1	1	1	1
L495/Flare Trip	8	2	1	1	2	1	2

NOTE: Rounds have been rounded up to the nearest whole figure.

Ammunition figures based on the following numbers of weapons per battery: M-16 131, M9 60, M-240G 4, M-2 4, Mk-19 4, SAW 8, and M203 10.

Table E-7. M-198 Battery (6-Gun), Personnel.

	E1-E5	E6-E9	O1-O3	Totals
USMC	123	13	8	144
USN	3	0	0	3
Totals	126	13	8	147

Table E-8. M-198 Battery (6-Gun), Selected Major Equipment.

Items	Authorized Quantities	Embarkation Data		Cargo Capacity for Authorized Quantity		
		Ft ²	Lbs	Ft ³ *	Gals	Lbs
M923 Truck, Cargo, 5-ton	16	3,328	366,048	7,280		160,000
M101A3, Trailer	5	380	67,500	865		7,500
M105A1 Trailer, 1½-ton	8	768	21,360	2,224		24,000
M149 Trailer, Water	1	101	2,530		400	
M998 HMMWV	5	528	25,300	395**		25,000
M1043 HMMWV (Armored)	3	318	17,931			14,500
AN/MRC 145 Radio Set	4	424	20,800			
MC 4000 Forklift	1	114	8,000			
M198 Medium Towed Howitzer	6	1,197	93,600			
* Cargo capacity under bows. ** Cargo capacity to top of side racks.						

Table E-9. M-198 Battery (6-Gun), Class V Small Arms Combat Planning Rates.

DODIC/Description	Basic Allowance	Armor Heavy		Infantry Heavy		Composite	
		Assault	Sustained	Assault	Sustained	Assault	Sustained
A059/5.56mm Ball	40,950	1,559	463	717	448	1,156	455
A061/5.56mm Tracer	1,170	762	129	193	106	490	117
A064/5.56mm 4&1 Linked	0	0	0	0	0	0	0
A131/7.62mm 4&1 Linked	3,200	136	23	281	37	207	31
A363/9mm	900	31	24	27	25	29	24
A518/.50 Cal SLAP 4&1 Linked	800	62	34	14	23	38	28
A576/.50 Cal 4&1 Linked	1,600	706	390	155	259	432	315
B504/40mm Green Star Parachute	3	5	1	4	1	4	1
B505/40mm Red Star Parachute	3	5	1	4	1	4	1
B506/40mm Red Smoke	3	2	1	2	1	2	1
B508/40mm Green Smoke	5	2	1	2	1	2	1
B509/40mm Yellow Smoke	3	2	1	2	1	2	1
B535/40mm White Star Parachute	20	5	1	5	1	5	1
B542/40mm HEDP LKD	1,152	142	71	79	66	110	68
B546/40mm HEDP	180	11	12	10	12	11	12
G881/Gren Fragmentation	75	8	6	8	7	8	6
G900/Gren Incendiary	4	1	1	1	1	1	1
G940/Gren Green Smoke	12	1	1	1	1	1	1
G945/Gren Yellow Smoke	12	1	1	1	1	1	1
G950/Gren Red Smoke	12	1	1	1	1	1	1
G930/Gren HC Smoke	12	1	1	1	1	1	1
G960/Gren Violet Smoke	12	1	1	1	1	1	1
L603/Sig Red Star Cluster	9	1	1	1	1	1	1
L307/Sig White Star Cluster	9	1	1	1	1	1	1
L311/Sig Red Star Parachute	9	1	1	1	1	1	1
L312/Sig White Star Parachute	9	1	1	1	1	1	1
L314/Sig Green Star Cluster	9	1	1	1	1	1	1
L323/Sig Smk Ground RP	9	1	1	1	1	1	1
L324/Sig Smk Ground GP	9	1	1	1	1	1	1
L495/Flare Trip	8	2	1	1	2	1	2

NOTE: Rounds have been rounded up to the nearest whole figure.
Ammunition figures based on the following numbers of weapons per battery: M-16 117, M9 30, M-240G 4, M-2 4, Mk-19 4, SAW 6, and M203 10.

Table E-10. M-198 Battery (6-Gun), Class V Artillery Ammunition Combat Planning Rates.

DODIC/Description	Basic Allowance	Armor Heavy		Infantry Heavy		Composite	
		Assault	Sustained	Assault	Sustained	Assault	Sustained
D501/Proj ADAM-L	5	2	1	3	2	3	1
D502/Proj ADAM-S	9	11	2	6	3	8	2
D505/Proj ILLUM M485A2	5	3	1	2	1	3	1
D510/Proj COPPERHEAD	1	2	1	1	1	1	1
D514/Proj RAAMS-S	4	6	3	7	2	6	2
D515/Proj RAAMS-L	2	1	2	1	3	1	3
D528/Proj SMOKE M825	36	4	2	4	2	4	2
D544/Proj HE	198	78	20	44	15	60	17
D550/Proj WP	12	10	3	9	2	9	2
D563/Proj DPICM	190	19	4	37	3	29	4
D579/Proj HE RAP	78	78	20	44	15	60	17
D864/Proj DPICM BB	137	19	4	37	3	29	4
Projectile Subtotals	677	233	63	195	52	213	56
D532/Prop M203 RB	243	107	26	89	20	98	22
D533/Prop M119A1/A2	122	35	10	30	8	32	9
D540/Prop M3A1 GB	64	19	5	16	5	18	5
D541/Prop M4A2 WB	313	89	24	75	20	82	21
Propellant Subtotals	742	250	65	210	53	230	57
N289/Fz ET M762*	404	65	18	99	16	83	17
N290/Fz ET M767**	35	27	7	17	5	22	6
N291/Fz VT M732A2***	50	20	5	11	4	15	5
N340/Fz PD M739****	218	127	32	72	24	99	27
N569/Fz CP Mk 399-1	4	2	1	1	1	2	1
Fuze Subtotals	711	241	63	200	50	221	56
N523/Primer M82	740	249	63	208	50	228	56

NOTE: Rounds and weights have been rounded up to the nearest whole figure.

*N285/Fz MTSQ M577 may be substituted.

**N286/Fz MTSQ M582 or N278/Fz MTSQ M564 may be substituted.

***N264/Fz VT M732 may be substituted in deep-well projectiles.

****N335/Fz PD M557 or N311/Fz PD M572 may be substituted.

Table E-11. Artillery Battalion, Personnel.

	E1-E5	E6-E9	W1-W4	O1-O3	O4-O5	Totals
USMC	507	69	5	36	6	623
USN	12	1	0	5	0	18
Totals	519	70	5	41	6	641

Table E-12. Artillery Battalion, Selected Major Equipment.

Items	Authorized Quantities	Embarkation Data		Cargo Capacity for Authorized Quantity		
		Ft ²	Lbs	Ft ³ *	Gals	Lbs
M923 Truck, Cargo, 5-ton	58	12,064	1,326,924	26,390		580,000
M936, Truck, Wrecker, 5-ton	2	470	76,932			
M105A1 Trailer, 1½-ton	28	2,688	74,760	7,784		84,000
M101A3, Trailer	27	2,052	36,450	4,671		40,500
M149 Trailer, Water	5	505	12,650		2,000	
M998 Truck, Utility	33	3,485	166,980	2,607**		165,000
M1043 HMMWV (Armored)	9	954	53,793			
AN/MRC 145 Radio Set	18	1,908	93,600			
AN/MRC 138 Radio Set	5	530	26,750			
JOM-1 Steam Cleaner	2	70	2,200			
M1305 Truck, Ambulance	1	106	5,361			
MC 4000 Forklift	5	570	40,000			
M198 Medium Towed Howitzer	18	3,591	280,800			
* Cargo capacity under bows.						
** Cargo capacity to top of side racks.						

Table E-13. Artillery Battalion, Class V Small Arms Combat Planning Rates.

DODIC/Description	Basic Allowance	Armor Heavy		Infantry Heavy		Composite	
		Assault	Sustained	Assault	Sustained	Assault	Sustained
A059/5.56mm Ball	168,700	6,422	1,906	2,952	1,845	4,761	1,873
A061/5.56mm Tracer	4,820	3,138	530	796	437	2,017	479
A064/5.56mm 4&1 Linked	6,400	1,942	441	214	371	1,105	402
A131/7.62mm 4&1 Linked	12,800	541	91	1,121	147	828	123
A363/9mm	4,500	151	118	120	131	141	120
A576/.50 Cal 4&1 Linked	6,400	2,823	1,558	617	1,035	1,728	1,258
A518/.50 Cal SLAP 4&1 Linked	3,200	246	136	54	90	151	110
B504/40mm Green Star Parachute	12	17	1	16	1	16	1
B505/40mm Red Star Parachute	12	17	1	16	1	16	1
B506/40mm Red Smoke	10	8	1	8	2	8	1
B508/40mm Green Smoke	20	8	1	8	2	8	1
B509/40mm Yellow Smoke	10	8	1	8	2	8	1
B535/40mm White Star Parachute	80	20	1	20	1	20	1
B542/40mm Linked	4,608	565	284	314	264	440	272
B546/40mm HEDP	720	44	45	39	47	42	46
G881/Gren Fragmentation	300	33	24	32	29	33	27
G900/Gren Incendiary	16	1	1	1	1	1	1
G940/Gren Green Smoke	48	4	2	4	2	4	2
G945/Gren Yellow Smoke	48	2	1	4	2	3	1
G950/Gren Red Smoke	48	5	2	5	2	5	2
G930/Gren HC Smoke	48	2	1	2	1	2	1
G960/Gren Violet Smoke	48	7	3	5	2	6	2
L603/Sig Red Star Cluster	36	1	1	1	1	1	1
L307/Sig White Star Cluster	36	1	1	1	1	1	1
L311/Sig Red Star Parachute	36	1	1	1	1	1	1
L312/Sig White Star Parachute	36	1	1	1	1	1	1
L314/Sig Green Star Cluster	36	1	1	1	1	1	1
L323/Sig Smk Ground RP	36	1	1	1	1	1	1
L324/Sig Smk Ground GP	36	1	1	1	1	1	1
L495/Flare Trip	128	3	9	3	8	3	8

NOTE: Rounds have been rounded up to the nearest whole figure.
 Ammunition figures based on the following numbers of weapons: M-16 482, M9 150, M-240G 16, M-2 16, Mk-19 16, and SAW 26.

Table E-14. Artillery Battalion, Class V Artillery Ammunition Combat Planning Rates.

DODIC/Description	Basic Allowance	Armor Heavy		Infantry Heavy		Composite	
		Assault	Sustained	Assault	Sustained	Assault	Sustained
D501/Proj ADAM-L	14	5	2	8	4	7	3
D502/Proj ADAM-S	27	32	4	18	8	24	6
D505/Proj ILLUM M485A2	13	8	3	5	3	7	3
D510/Proj COPPERHEAD	2	4	1	2	1	3	1
D514/Proj RAAMS-S	11	16	9	19	5	17	6
D515/Proj RAAMS-L	6	1	6	3	7	2	7
D528/Proj SMOKE M825	108	12	6	11	5	11	6
D544/Proj HE	593	232	58	131	44	180	49
D550/Proj WP	36	29	7	25	6	27	6
D563/Proj DPICM	569	57	12	111	9	85	10
D579/Proj HE RAP	234	232	58	49	131	180	49
D864/Proj DPICM BB	410	57	12	111	9	85	10
Projectile Subtotals	2,023	685	178	575	145	628	156
D532/Prop M203 RB	729	319	77	267	58	292	66
D533/Prop M119A1/A2	364	105	28	88	23	96	25
D540/Prop M3A1 GB	190	57	15	48	13	53	13
D541/Prop M4A2 WB	937	267	70	223	58	244	63
Propellant Subtotals	2,220	748	190	626	152	685	167
N289/Fz ET M762*	1,211	194	53	296	47	247	50
N290/Fz ET M767**	104	80	20	51	15	65	17
N291/Fz VT M732A2***	149	58	15	33	11	45	13
N340/Fz PD M739****	654	379	94	216	71	295	80
N569/Fz CP Mk 399-1	12	5	2	3	1	4	1
Fuze Subtotals	2,130	716	184	599	145	656	161
N523/Primer M82	2,219	747	189	624	150	684	165

NOTE: Rounds and weights have been rounded up the nearest whole figure.

*N285/Fz MTSQ M577 may be substituted.

**N286/Fz MTSQ M582 or N278/Fz MTSQ M564 may be substituted.

***N264/Fz VT M732 may be substituted in deep-well projectiles.

****N335/Fz PD M557 or N311/Fz PD M572 may be substituted.

Table E-15. Ammunition Packing Dimensions, Artillery Ammunition.

Projectiles					
DODIC	Nomenclature	# of Rounds	Weight (lbs)	Dimensions (in)	Cube (ft ³)
D501	ADAM-L (M692)	8	887	39 3/8 x 14 1/2 x 29	9.7
D502	ADAM-S (M731)	8	887	39 3/8 x 14 1/2 x 29	9.7
D505	ILLUM M485A2	8	783	27 1/8 x 13 5/8 x 32	6.8
D510	COPPERHEAD (M712)	6	1,358	61 x 33 x 27 1/2	32
D514	RAAMS-S (M741)	8	882	39 3/8 x 14 5/8 x 29 1/8	9.7
D515	RAAMS-L (M718A1)	8	882	39 3/8 x 14 5/8 x 29 1/8	9.7
D528	SMOKE, WP (M825A1)	8	874	39 3/8 x 14 1/2 x 29	9.7
D544	HE (M107)	8	798	27 1/8 x 13 5/8 x 32	6.8
D550	SMOKE, WP (M110A2)	8	829	27 1/8 x 13 5/8 x 32	6.8
D563	DPICM (M483A1)	8	874	39 3/8 x 14 1/2 x 29	9.7
D579	HE, RAP (M549A1)	8	816	38 3/4 x 14 5/8 x 29 1/8	9.5
D864	DPICM, BB (M864)	8	870	39 3/8 x 14 1/2 x 29	9.7
Propellants					
DODIC	Nomenclature	# of Rounds	Weight (lbs)	Dimensions (in)	Cube (ft ³)
D532	M203 RB	1	56		
D533	M119A1/A2	1	45		
D540	M3A1 GB	2	29		
D541	M4A2 WB	1	27		
Fuzes					
DODIC	Nomenclature	# of Rounds	Weight (lbs)	Dimensions (in)	Cube (ft ³)
N289	Fz ET M762	16	47	14.62 x 13.90 x 8.56	1.0
N290	Fz ET M767	16	47	14.62 x 13.90 x 8.56	1.0
N291	Fz VT M732A2	16	47	14.62 x 13.90 x 8.56	1.0
N340	Fz PD M739	16	47	14.62 x 13.90 x 8.56	1.0
N569	Fz CP Mk 399-1	16	47	14.62 x 13.90 x 8.56	1.0
Primers					
DODIC	Nomenclature	# of Rounds	Weight (lbs)	Dimensions (in)	Cube (ft ³)
N523	Primer M82	400	34	17.38 x 11.5 x 8.12	0.9

Table E-16. Ammunition Packing Dimensions, Small Arms.

DODIC/Description	Package Data		
	Rounds	Ft ³	Lbs
A064/5.56mm 4&1 Linked	1,600	1.2	47
A063/5.56mm Tracer	1,640	1.0	67
A071/5.56mm Ball	1,680	1.0	70
A131/7.62mm 4&1 Linked	800	.8	75
A363/9mm Ball	2,400	3.9	72
A518/.50 Cal SLAP 4&1 Linked	220	1.3	86
A576/.50 Cal 4&1 Linked	220	1.3	86
B504/40mm Green Star Parachute	44	1.0	48
B505/40mm Red Star Parachute	44	1.0	48
B506/40mm Red Smoke	44	1.0	57
B508/40mm Green Smoke	44	1.0	57
D509/40mm Yellow Smoke	44	1.0	57
B535/40mm White Star Parachute	44	1.0	57
B546/40mm HEDP	72	1.6	53
B542/40mm Linked	72	1.4	125
G881/Gren Fragmentation	30	1.4	51
G900/Gren Incendiary	16	0.8	47
G930/Gren HC Smoke	16	0.8	42
G940/Gren Green Smoke	16	0.8	34
G945/Gren Yellow Smoke	16	0.8	34
G950/Gren Red Smoke	16	0.8	42
G960/Gren Violet Smoke	16	0.8	34
L306/Sig Red Star Cluster	36	1.6	56
L307/Sig White Star Cluster	36	1.6	56
L311/Sig Red Star Parachute	36	1.4	67
L312/Sig White Star Parachute	36	1.4	67
L314/Sig Green Star Cluster	36	1.5	56
L323/Sig Smk Ground RP	36	1.5	56
L324/Sig Smk Ground GP	36	1.5	56
L495/Flare Trip	32	1.8	47

APPENDIX F

HELIBORNE ARTILLERY RAIDS

General

Heliborne artillery raids require unique planning considerations and preparation. This appendix outlines general tactics, techniques, and procedures to conduct heliborne artillery raids. See also FMFM 7-32, *Raid Operations*.

Tables F-1 through F-7 and figures F-1 through F-6 are detailed guides for an artillery raid force. They are not prescriptive; they are planning examples. See pages F-10 through F-20.

Characteristics

An artillery raid is the movement of an artillery unit (or portion of that unit) to a designated firing position to attack an HPT with artillery fires followed by the immediate withdrawal to a safe location.

The artillery raid is a unique operation because the firing position is usually beyond the beachhead or FLOT. Due to the limited protection at these locations, speed and surprise are essential. The intent is to rapidly insert an artillery force and swiftly deliver artillery fire on single or multiple targets. This must be done using the minimum amount of equipment and personnel to accomplish the mission. Planning should allow for the force to withdraw immediately upon completion of the fire mission. These characteristics will govern the planning and execution phases of the operation.

Command and Control

The senior maneuver commander assigns an artillery raid to an artillery battery or battalion. The raid force consists of five elements: command, support, assault, security, and observer. The senior artillery commander assigned the raid mission is the raid force commander (RFC). The mission commander is assigned from the supporting helicopter squadron. Open and direct communications between the RFC and mission commander during planning are imperative for the raid to succeed.

Mission Profile

Commanders and staffs must understand the purpose of the raid as soon as the mission is assigned, i.e., upon receipt of the warning order. They must also understand the risk involved and the possible loss of key personnel and equipment. This understanding is extremely important as it will guide many of the decisions during planning. The following six missions may be assigned to the artillery raid force:

- **Destroy.** To permanently render a target combat ineffective. This mission is best accomplished with an FO equipped with a laser and accurate locating device.
- **Neutralize.** Temporarily render threat personnel or material operationally ineffective. This mission is best accomplished with an FO.

- **Suppress.** Preventing threat personnel, weapons or equipment from engaging friendly forces usually associated with a specified amount of time.
- **Harass.** Confusing, disorganizing or degrading threat forces.
- **Deceive.** Deceiving the threat as to the true intent of friendly units.
- **Interdict.** Preventing the threat from using an area, route or point.

Security Levels

Based on the threat at the firing position, one of the three following security levels will be used:

- **Security Level I**—negligible threat to friendly forces.
- **Security Level II**—squad-size threat units or smaller threatening raid site.
- **Security Level III**—threat units larger than a squad-size threatening raid site.

Raid Force Elements

Based on the situation, the RFC determines the final force composition. Composition depends on helicopter availability and the helicopter embarkation plan.

The CE and support elements are the advance party. During security level II and III operations, the security element precedes the advance party into the firing position.

The command element provides C2 for the raid force and maintains communications with the MEU or ground element.

The support element provides fire direction, lays the howitzers, lays wire (if required), and provides helicopter transport support of howitzers.

The assault element provides gun crews, howitzers, and ammunition.

The security element provides local security for the raid force, including sweeping the raid position and establishing perimeter defense.

The observer element observes fires on the target and reports BDA to the controlling FDC. This element can include FO teams, reconnaissance teams, aircraft, etc. Not all fires are required to be observed. The type of observer, if employed, is situationally-dependent.

Mission Planning Steps

To execute a raid successfully, planning must be detailed. However, there will be occasions when the time available between the warning order and L-hour will be compressed. Planning will be considerably shorter. Rehearsals are vital tools whenever METT-T permits. Many considerations must be addressed. These include, but are not limited to, the following:

- **Target.** The nature of the target will dictate the number of weapons, amount of ammunition, type of observer, etc.
- **Number of Weapons.** The optimum number of howitzers for a raid is four. This number may vary depending on the nature of the target and helicopter support available.
- **Ammunition.** Based on the nature of the target, required ammunition will be determined via munitions effects tables or attack guidance criteria.
- **Aircraft.** The M198 can be transported externally by the CH-53E or Army assets. A four-gun raid requires four CH-53Es to lift the guns, ammunition, and gun crews. Ideally, there are also two CH-46s for the advance party. Additional aircraft may include attack helicopter escorts for ingress and egress protection and to assist the security element as it deploys into the LZ. A UH-1N may be necessary to serve in a C3 capacity as well.
- **XM 777.** The XM 777 will provide commanders with more flexibility due to its light weight and P3I. The XM 777 will be transportable by the CH-53E, CH-53D, and V-22.

Landing Zone Selection

The artillery unit recommends the LZ *location*, but helicopter units advise on LZ *suitability*. During shipboard operations, the flight deck is the LZ. Flight deck control is provided by the ship. HST training and assistance may be requested from the landing support element of the CSSE. The artillery unit provides instructions to the transporting unit on the LZ's location, disposition of lifting equipment, and weight of the load. During small-scale operations, communications and terminal guidance may be provided by the artillery unit. LZ selection and planning factors include LZ size, accessibility, surface conditions, navigational aids, suitable terrain, and the threat.

Usually, the longest effective standoff range is desired. This distance will depend on ammunition type (propelling charge or projectile). LZ site studies will be conducted, if time permits. It is important that the altitude of the target be considered. (A target with a high above gun altitude will decrease the maximum range of the weapon system.) At a minimum, an alternate and primary LZ will be planned. Deception sites will be planned to further deceive the threat of the true intent of the mission.

The LZ should accommodate simultaneous insertion of all helicopters with howitzers in the wave with the most serials.

Natural cover and concealment should be present, but not so prohibitive as to present a restrictive XO's minimum quadrant elevation.

A nearby area must be designated to stage helicopters during the mission. The situation will dictate if the staging area will be airborne or in a nearby LZ. The staging area should be out of threat reach to minimize potential threat engagement. The area should offer covered and concealed air routes into and out of the LZ.

LZ soil composition should be appropriate to accommodate firing high propellant charges.

Surface materials must be stable to prevent debris from clogging engines. Loss of visibility, possible personnel injury or damage to the helicopter from flying objects must be considered, as well as trafficability for vehicle, troop, and logistic mobility.

Grass and vegetation from newly mowed fields can clog engine intakes. Loose dirt and sand can damage engines and rotor blades, cause temporary loss of visibility, and is a safety hazard for the aircrew and lifted troops.

Snow is not recommended as an LZ surface without prior reconnaissance. It may restrict visibility, the underlying surface may be unsatisfactory, snow may be too deep for landing, and surface unevenness may be obscured by drifts.

Dry grasslands represent a fire hazard when exposed to hot exhaust gases.

Flooded rice fields that are mire and water of greater depth than is anticipated hinder troop movement.

Obstacles in the LZ must be evaluated. Tall grass or brush that appears relatively smooth from the air can conceal humps, boulders or terrain faults that can damage or tip a landing helicopter. The LZ should be free of debris, stumps, rocks, holes, and trenches that exceed 10 inches in height or depth. Brush, if over 3 feet high, is usually considered restrictive to landing helicopters because of damage to fuselage and tail rotors.

The nature of approaches to and exits from the LZ must also be evaluated. It is undesirable to establish LZs in locations that require vertical ascent or descent by the helicopters. To permit the most effective use of helicopters, approaches to and exits from LZs must be clear of communications wire, trees, powerlines, and other vertical obstacles, particularly when conducting mass landings. Required LZ site is directly associated with the height of obstructions surrounding the LZ and number of helicopters to be landed at one time.

To accurately assess these considerations, accurate intelligence must be available. If intelligence data is not available, it must be arranged immediately before planning can be completed.

Landing Zone Marking

How to mark personnel and equipment (howitzer/ammunition) insertion and extraction points will be discussed with the pilots during the initial mission brief to eliminate confusion in the LZ. If this does not happen, an HLZ brief can inform the pilots how the LZ is being marked.

If the LZ is not easily identifiable from the air, navigational aids should be used to vector aircraft to desired locations. Navigational aids include panel markers, strobe lights, smoke grenades, and radios. Reconnaissance teams and HST personnel, through the use of electronic or visual means, can aid in terminal guidance and control of helicopters. An easily identifiable point of reference (a marking T) should be established to direct aircraft to specific points in the pick-up and/or LZ.

Daytime Operations

Smoke can draw the pilot's eyes onto the zone and demonstrate wind speed/direction. It can also mark a specific point to insert and extract personnel or equipment.

Air panels may be used to depict the AoF in addition to a backup for smoke. Caution should be exercised when emplacing air panels so they are not disrupted from rotor wash.

Nighttime Operations

Infrared/red chem lights are the most visible to pilots wearing night vision goggles, and can be used in the same ways as smoke and air panels.

Infrared strobes are extremely useful for marking during low visibility. Techniques for employing strobes in an LZ are:

- Strobe on muzzle brake.
- Strobe 20 to 40 meters forward of howitzer on deck.

Howitzers

Howitzers desire to hover, land, and take off facing into the wind. When possible, an LZ is chosen to best accommodate the howitzers, insertion/extraction points, and the wind. Howitzers should face into the wind.

Ample room should be available to the right of the howitzer for the personnel extraction point so personnel are away from the tail rotor when embarking. If room is not available to the right of the howitzer, ample room should be to the rear of the howitzer.

The gun section should wait next to the howitzer for the helicopter to land at the personnel extraction point. This reduces unnecessary movement in the LZ and provides additional maneuvering for the helicopter.

The LZ slope must also be considered and tempered against the wind speed and direction at the LZ. The slope must not exceed 8 degrees where the helicopter is intended to land for risk of tipping or insufficient rotor clearance. The slope must not exceed 5 degrees where the howitzer is intended to be positioned as this prevents the howitzer from firing.

Helicopter Support Team

HST personnel must be actively involved in the raid brief and rehearsals. Considerations for

augmentees to gun crews, security forces, etc., must be addressed.

Firing Data

Firing data for all howitzers will be precomputed using BUCS-R if possible. All available information affecting ballistic computations will be inputted before the raid. Data will be computed from each LZ using the lowest charge to limit any site-to-crest problems. Data will be given to the section chiefs in advance and will be based on a map spot grid unless survey control is established.

Go/No-Go Criteria

Certain criteria must be established before the mission starts and to aid in deciding if the mission should continue under duress. These criteria serve solely as guides with the mission commander having final deciding authority. Use the following techniques when determining go/no-go criteria:

- If both advance party helicopters are lost.
- If the raid element loses more than 50 percent of its howitzers/ammunition.
- If the minimum number of helicopters required to conduct the mission is unavailable.
- Loss of communications with the mission commander.

Duties of Key Personnel

Raid Force Commander

- Determine viability of raid.
- Direct the mission planning process.
- Select firing positions maintaining dispersion between howitzers.
- Ensure the advance party is in the correct LZ.

- Determine the OS and FDC and howitzer locations upon arrival at the LZ.
- Ensure the LZ is secure.
- Supervise the smooth operation of all aspects of the raid.
- Supervise LZ marking.
- Ensure accountability upon extraction of personnel and equipment.

Executive Officer/Platoon Commander

- Inspect artillery raid personnel, equipment, and ammunition.
- Ensure communications are maintained with the RFC and the helicopter mission commander.
- Set up and orient the aiming circle.
- Lay the howitzers.
- Assist in hasty survey, met data, and computing data as required.

Battery Gunnery Sergeant

- Emplace the local security force.
- Ensure accountability of personnel and equipment.
- Ensure rapid emplacement of howitzers.
- Ensure preparation for rapid extraction.

Operations Chief

- Supervise FDC planning and ensure all BUCS-R have pre-computed data loaded.
- Set up GPS at aiming circle if survey team is unavailable.
- Collect data for technical fire direction and supervise fire controlman computations.
- If time permits, input data in back up computer system.
- Set up chart and check firing data.
- Supervise issuing of fire commands.
- Ensure all maps, records, and FDC equipment are extracted.

Section Chiefs

- Ensure all personnel and equipment are ready (inspect gear and personnel thoroughly before the raid).
- Ensure rapid offload of ammunition and gun.
- Begin ammunition preparation before receiving fire commands.
- Supervise the rapid emplacement, firing, and extraction of the howitzer.
- Maintain communications with the RFC.
- Be prepared to assume security mission on order.
- Ensure recovery of all personnel and equipment upon extraction.

Fire Controlman

- Input all preplanned data in all BUCS-R before departing for the raid.
- Prepare charts and records of fire before raid departure.
- Prepare computer checklist and be prepared to enter data upon arrival at firing position.
- Maintain records of fire.
- Send fire commands to howitzers once approved by operations chief.
- Be prepared to receive subsequent corrections.
- Extract all records and equipment.

Radio Operator

- Establish preplanned communications as quickly as possible and as close to the FDC as terrain and helicopter routes will allow.
- Establish communications with the following priorities:
 - Observers, as required.
 - Helicopters.
 - Higher headquarters.
 - Simultaneous master station, as required.
- Pass all necessary information to the FDC and the RFC.
- Maintain communications until directed.

- Recover all communications equipment and material, including messages and notes, upon extraction.

Gun Guides

- Set up panel markers/chem lights as briefed to mark location for the assault element.
- Establish communications with aiming circle/FDC.
- Record initial deflection.
- Act as a legman under guidance of HST leader, as required.
- Help provide local security until howitzers arrive.
- Announce initial deflection to gunner.
- Assist in emplacing, firing, and march ordering of howitzer.
- Ensure all howitzer equipment is extracted.

Security Element

- Receive briefing on layout of LZ/firing position before the raid.
- Upon landing, conduct sweep of area.
- Establish perimeter security.
- Report security status as directed to the RFC.

Corpsman

- Have medical equipment necessary for raid mission.
- Upon landing, stay with FDC.
- Respond to any calls for medical attention.

Survey Personnel (If Required)

- Determine firing point location.
- Establish direction.

HST Leader

- Provide all required personnel and equipment to quickly guide helicopters onto marked howitzer positions, and recover howitzer at the end of the mission.

- Inspect howitzers and ammunition slings before departure. Report findings to the artillery raid commander.
- Assist gun guides in marking howitzer positions.
- Assist in rapid insertion of howitzers.
- Upon the order to march order, inspect howitzer loads and slings and assist in preparing for extraction.
- Guide helicopters in and supervise the reattaching of howitzers.

Execution Sequence

Insertion (Security Element/Advance Party)

The security element/advance party arrives at the firing position, secures the site, and establishes perimeter defense. It performs the following:

- Conducts hasty survey to establish firing position location and direction, as required.
- Establishes communications with observers, the MEU or ground element, as directed.
- Positions the aiming circle and prepares the gun position for howitzers.
- Computes firing data if not previously computed.
- Prepares for arrival of the assault element.

Actions in Firing Position

The observer element, if required, reports to the controlling FDC. The assault element arrives at the raid site and positions and prepares ammunition once it arrives at the firing position. It then lays the howitzers; conducts and completes firing; and prepares the howitzers for extraction.

Extraction

All elements prepare for extraction by collecting all refuse from the raid site, and prepare to retrograde. Elements extract in the following sequence:

- Assault element.
- Advance party.

- Observer element.
- Security element.

All elements conduct a mission debrief.

Survey Operations

Battalion survey support may not be available unless a PADS is used via a UH-1. If PADS is unavailable, the firing battery must use expedient means to determine direction, location, and height. Direction is the most important element of survey. Every available means will be used to determine an accurate direction. An error in direction is magnified over distance; an error in location is constant.

Determining Direction (in Preferred Order)

The PADS contains a gyroscope that will provide azimuths to +/- 0.4 PE.

The BUCS-R hasty astro program enables the battery to determine direction to various accuracies depending on the type of instrument. If the firing battery has attached a battalion surveyor with a T-2E theodolite, the accuracy of an astronomic observation with this instrument is +/- 0.3 mils. If the firing battery is using an M2A2 aiming circle, the accuracy of an astronomic observation is +/- 2.0 mils. To perform an astronomic observation, one of the known celestial bodies—the sun or one of 73 survey stars—must be visible from the OS. Inclement weather, heavy overcast conditions or smoke may negate this method.

The north-finding module is the gyroscope used with the modular universal laser equipment and target location designation handoff system. The north finding module can be placed into a survey mode that will provide an accurate direction to +/- 2.0 mils.

A declinated M2A2 aiming circle could be used as a last resort if the instrument was declinated

within 40 kilometers of the firing position. A declinated aiming circle will provide a direction to an accuracy of +/- 10.0 mils.

The declination constant of an aiming circle may be affected by the strong magnetic field generated by the helicopter's rotors.

Determining Location

The PLGR with valid crypto variable keys loaded and verified provides a location to an accuracy of 10 meters circular error probable (CEP). The PLGR is a hand held unit but cannot provide accurate direction.

The PADS in a UH-1 will provide location using 10 minute zero-velocity updates to an accuracy of 7 meters CEP between 0 to 65 degrees latitude north or south and 10 meters CEP between 65 to 75 degrees latitude north or south. The advantage of the PADS is that it provides accurate direction, location, and height. However, the PADS/UH-1 must be landed at the OS and the EOL to establish positioning and orientation.

After determining an accurate direction, a hasty three-point resection can be performed by using the BUCS-R, BCS or graphic resection. The accuracy of a three-point resection depends on the accuracy of the location of the visible known points and the angle-measuring instrument available. The accuracy of a three-point resection is seldom better than 50 meter CEP.

A map spot is the least preferred method of determining location. The accuracy of a map spot depends on prominent terrain features available, map accuracy, and the proficiency of the individual performing the map spot. All other means of determining location will be exhausted before resorting to this method.

Determining Height (in Preferred Order)

The PADS will provide an accurate height to 3 meters PE. The PADS is more accurate than the PLGR in location and height. However,

the required logistical support and the fact that it must be positioned on the OS relegates this system to the second preferred method.

After determining an accurate direction, a hasty three-point resection can be performed and the coordinates used to derive a height from the map.

The map spot method is only used as a last resort after all other means have been exhausted.

Organization for Movement

Organization of the artillery unit for movement is an integral part of planning for immediate employment upon landing. The artillery unit may be organized into three echelons: assault, resupply or follow-up, and rear.

Assault Echelon

Composition of the assault echelon varies with the assigned mission, available aircraft, and duration of the operation. Notionally, the assault echelon is composed of the advanced party and a howitzer section. Generally, the assault echelon consists of the battery elements essential to the control or delivery of immediate support. Organization of the advanced party depends on the battery's composition and the time available for occupation. An advance party is normally led by the battery commander and consists of enough personnel to initiate observation, communications, and survey. The advance party guides the battery into position. If possible, the advance party should contain a forklift.

Resupply or Follow-up Echelon

The resupply or follow-up echelon consists of combat support personnel, supplies, and equipment to sustain the assault echelon until linkup or extraction. Personnel, supplies, and equipment are transported to the assault echelon by air or surface means.

Rear Echelon

The rear echelon includes all personnel, supplies, and equipment not included in the assault and resupply echelons. The rear echelon supports the assault and resupply echelons by providing administrative, maintenance, and supply support in the rear area.

Loading

Loading artillery for movement may commence during the planning phase and continue through the movement phase. Internal and external loads transport artillery personnel, vehicles, equipment, and supplies. Piggyback loads permit the howitzer and ammunition to be moved by one helicopter. Establishing loads requires flexibility in planning the operation, loading of supplies and equipment, and conducting the operation.

Aircraft Load Data

The proposed load must be within the allowable cargo load limit of a particular aircraft. The artillery unit obtains the allowable cargo lift from the helicopter unit.

Pickup/Landing Zone Organization

The artillery unit is responsible for pickup/LZ organization. Preparing the pickup zone includes rigging loads, positioning marking devices, positioning equipment for rapid pickup, and controlling incoming aircraft. Initial load preparation should begin at least 2 hours before the first aircraft arrives. Artillery personnel inspect loads for completeness and compactness. Loose articles should be secured by artillery personnel; e.g., tents within 50 to 75 meters of the landing site or along the approach path should be lowered and secured. The battery retains its firing capability as

long as possible. In organizing the pickup/LZ, the artillery unit will perform the following:

- Reduce air-to-ground transmissions required for coordination.
- Position loads to reduce flights over the battery, particularly resupply flights.
- Position loads so the aircraft can approach the LZ into the wind.
- Facilitate rapid orientation of passengers debarking from the aircraft by using clock direction with reference to the helicopter's nose.

Terminal Control

Terminal control and responsibility are established in the planning phase. Normally, the HST provides helicopter control. In the absence of HST, the artillery unit controls incoming aircraft in the pickup zone. The unit provides threat situation, wind direction and velocity, surface conditions, landing direction, and clearance information to the flight. Landing site azimuth, field elevation, landing information, and other information may also be provided, when available.

Movement

Final coordination and briefings are completed before lift-off of the advance party. Confirmation is made on the exact location of the LZ, radio frequencies, call signs, flight route, order of march, and number of sorties. The interval between the arrival and departure of helicopters depends on the plan of maneuver, conditions in the LZ, and number of helicopters the LZ will accommodate. Ideally, the advance party should have enough time on the ground to prepare the site while the battery awaits the order to move forward. However, in fast-moving situations, the

advance party may be followed by the remainder of the assault echelon by as little as 5 minutes.

Movement Control

Helicopter control is established through radio transmissions or a color-code system. Radio control is slow and requires numerous transmissions to complete a landing. The color-code system conspicuously displays a colored marker on the ground to identify the LZ. Each load is then assigned a color that is conspicuously displayed on the load. The ground guide in the LZ wears an air-ground recognition vest or uses an air-ground recognition panel the same color as the assigned load. The pilot knows the color of his/her load before reaching the LZ. En route, the pilot notifies the terminal controller of the load's color and proceeds directly to the marked site or to the appropriate ground guide.

To instruct the pilot, ground guides use arm-and-hand signals and wear a colored vest during daylight operations; at night, ground guides use colored lights or illuminated batons. The reference point used to guide helicopters is the color-coded

load or panel marker. The helicopter crew chief can guide the helicopter to its pickup or release point. The crew chief observes the load or the panel marker through the helicopter hook hatch and directs the pilot to the pickup or release point via the helicopter intercom.

Occupation of Position

During the planning phase of a battery operation, the battery commander tentatively selects the location of key installations, plans the organization of the prospective LZ, and coordinates procedures for control of aircraft during the occupation. Immediately after the advance party arrives in the LZ, the battery commander designates battery center and positions the T-marker. Howitzers are released as near their firing positions as possible. A guide for each howitzer section clears the immediate position area of any loose debris and obstacles, prepares the position to receive equipment, and displays a marking device of the same color as that assigned to his/her section. Once the battery is on the ground, standard firing battery procedures are followed.

Table F-1. Notional Artillery Battery Lift (Advanced Party).

Unit	Echelon	Lift #	Load Composition ¹
M198 Battery (6 guns)	Advanced Party	1	Personnel: Battery Commander FDC, Comm, Terminal Controllers
	Advanced Party	2	Personnel: Gun Guides, Security Equipment: MC-4000 Forklift
	Howitzer Section	3-8	Personnel: Gun Section Equipment: M198 and Ammunition ²
	Resupply Echelon		Remainder of battery (personnel, equipment, and supplies) may be transported by helicopter or link up by ground means.
NOTE: The assault echelon is composed of the advanced party and howitzer section.			
1. The actual load composition depends on the type of helicopter and lift capability.			
2. Quantity of ammunition varies with the net type, helicopter lift capability, and type of ammunition and packaging.			

Table F-2. Helicopter Life Capacity Planning Guidance.

Helicopter	Lift Capacity (lbs)*
CH-53D	13,000
CH-53E	30,000

* Based on standard day conditions (15 degrees C, sea level, no wind or humidity) and 1 hour and 45 minutes of fuel onboard.

Table F-3. Cargo Net Capacity Planning Guidance.

Net	Cargo Volume	
	ft ³	lbs
A-22 Bag	66	2,500
5,000 Net	125	5,000
10,000 Net	380	10,000

Table F-4. Example Artillery Raid Ammunition Requirements.

The type and amount of small arms is based on the security level required. The type and amount of artillery ammunition is based on lift availability, munitions effects tables, and/or attack guidance.

Small Arms		
DODIC	NOMENCLATURE	ROUNDS PER WEAPON
A363	9mm ball	30
A071	5.56 ball	180
A131	7.62 linked ball	400
A576	.50 cal ball	200
B546	40mm HEDP	10
G881	M67 frag grenade	2 per person
G900	thermite grenade	2 per section chief

M198/LW 155 155mm Ammunition		
DODIC	NOMENCLATURE	ROUNDS PER HOWITZER
D563	shell DPICM	16
N286	M577 fuze MTSQ	16
N523	M82 primer	16
D541/D533	propellant charge (GB/WB)	16

Command Element (same for all security levels)					
LINE #	RANK	BILLET	MOS	WEAPON	NOTE
1	1stLt	XO/Plt Cmdr	0802	9mm	
2	Sgt	RTO	2531	M16A2	1
3	Cpl/LCpl	RTO	2531	M-203	1

Support Element (same for all security levels)					
LINE #	RANK	BILLET	MOS	WEAPON	NOTE
4	SSgt	operations chief	0848	9mm	
5	Sgt	artillery mechanic		M16A2	
6	Cpl	fire controlman	0844	M16A2	1
7	Cpl	HST	0481	M16A2	1
8	LCpl	HST	0481	M-203	1
9	HM3	corpsman	8404	9mm	
10	Cpl/Pvt	wireman	2512	M16A2	3
11	Sgt	survey	0843	M16A2	1,3
12	LCpl/Pvt	survey	0843	M16A2	1,3

Table F-5. Example Artillery Raid Task Organization.

Assault Element (same for all security levels)					
Gun Number - One					
LINE #	RANK	BILLET	MOS	WEAPON	NOTE
13	SSgt/Sgt	Section Chief	0811	9mm	
14	Cpl/Pvt	Gun Crewman/woman	0811	M-203	1
15	Cpl/Pvt	Gun Crewman/woman	0811	M16A2	1
16	Cpl/Pvt	Gun Crewman/woman	0811	M16A2	1
17	Cpl/Pvt	Gun Crewman/woman	0811	M16A2	1
18	Cpl/Pvt	Gun Crewman/woman	0811	M16A2	1
19	Cpl/Pvt	Gun Crewman/woman	0811	M16A2	1
20	Cpl/Pvt	Gun Crewman/woman	0811	M16A2	1
21	Cpl/Pvt	Gun Crewman/woman	0811	M16A2	1
Gun Number - Two					
LINE #	RANK	BILLET	MOS	WEAPON	NOTE
22	SSgt/Sgt	Section Chief	0811	9mm	
23	Cpl/Pvt	Gun Crewman/woman	0811	M-203	1
24	Cpl/Pvt	Gun Crewman/woman	0811	M16A2	1
25	Cpl/Pvt	Gun Crewman/woman	0811	M16A2	1
26	Cpl/Pvt	Gun Crewman/woman	0811	M16A2	1
27	Cpl/Pvt	Gun Crewman/woman	0811	M16A2	1
28	Cpl/Pvt	Gun Crewman/woman	0811	M16A2	1
29	Cpl/Pvt	Gun Crewman/woman	0811	M16A2	1
30	Cpl/Pvt	Gun Crewman/woman	0811	M16A2	1
Gun Number - Three					
LINE #	RANK	BILLET	MOS	WEAPON	NOTE
31	SSgt/Sgt	Section Chief	0811	9mm	
32	Cpl/Pvt	Gun Crewman/woman	0811	M-203	1,2
33	Cpl/Pvt	Gun Crewman/woman	0811	M16A2	1,2
34	Cpl/Pvt	Gun Crewman/woman	0811	M16A2	1,2
35	Cpl/Pvt	Gun Crewman/woman	0811	M16A2	1,2
36	Cpl/Pvt	Gun Crewman/woman	0811	M16A2	1,2
37	Cpl/Pvt	Gun Crewman/woman	0811	M16A2	1,2
38	Cpl/Pvt	Gun Crewman/woman	0811	M16A2	1,2
39	Cpl/Pvt	Gun Crewman/woman	0811	M16A2	1,2
Gun Number - Four					
LINE #	RANK	BILLET	MOS	WEAPON	NOTE
40	SSgt/Sgt	Section Chief	0811	9mm	
41	Cpl/Pvt	Gun Crewman/woman	0811	M-203	1,2
42	Cpl/Pvt	Gun Crewman/woman	0811	M16A2	1,2
43	Cpl/Pvt	Gun Crewman/woman	0811	M16A2	1,2
44	Cpl/Pvt	Gun Crewman/woman	0811	M16A2	1,2
45	Cpl/Pvt	Gun Crewman/woman	0811	M16A2	1,2
46	Cpl/Pvt	Gun Crewman/woman	0811	M16A2	1,2
47	Cpl/Pvt	Gun Crewman/woman	0811	M16A2	1,2
48	Cpl/Pvt	Gun Crewman/woman	0811	M16A2	1,2
Security Level I					
LINE #	RANK	BILLET	MOS	WEAPON	NOTE
49	Cpl	M240G Team Leader	0811	M16A2	
50	LCpl/Pvt	M240G Gunner	0811	M240G	

Table F-5. Example Artillery Raid Task Organization (Continued).

Security Level II. In addition to line numbers 49 and 50, the following personnel will be included:					
LINE #	RANK	BILLET	MOS	WEAPON	NOTE
51	SSgt	Security Chief	0811	9mm	
52	Sgt	Assistant Security Chief	0811	M16A2	
53	Cpl	M240G Team Leader	0811	M16A2	
54	LCpl/Pvt	M240G Gunner	0811	M240G	
55	Cpl/Pvt	Security Marine	0811	M16A2	
56	Cpl/Pvt	Security Marine	0811	M16A2	
57	Cpl/Pvt	Security Marine	0811	M-203	
58	Cpl/Pvt	Security Marine	0811	M16A2	
59	Cpl/Pvt	Security Marine	0811	M16A2	
60	Cpl/Pvt	Security Marine	0811	M-203	
61	Cpl/Pvt	Security Marine	0811	M16A2	
62	Cpl/Pvt	Security Marine	0811	M16A2	
Security Level III. In addition to line numbers 49 through 62, the following personnel will be included:					
LINE #	RANK	BILLET	MOS	WEAPON	NOTE
63	1Lt/2Lt	OIC Security	0802	9mm	
64	Sgt	Assistant Security Chief	0811	M16A2	
65	Sgt	M-2 Team Leader	0811	M16A2	
66	Cpl	M-2 Gunner	0811	M-2/9mm	
67	Cpl/Pvt	M-2 Assistant Gunner	0811	M16A2	
68	Cpl/Pvt	M-2 Ammo Marine	0811	M16A2	
69	Cpl/Pvt	Security Marine	0811	M16A2	
70	Cpl/Pvt	Security Marine	0811	M-203	
71	Cpl/Pvt	Security Marine	0811	M16A2	
72	Cpl/Pvt	Security Marine	0811	M16A2	

NOTES:
 1. May act as part of security element.
 2. Will not participate in raid unless more than two howitzers are required.
 3. As required.

Table F- 6. Helicopter Lift Requirement Matrix.

The CH-53D and V-22 may be used in place of the CH-53E when operating with the LW 155.

Howitzers	Security Levels	CH-46E	CH-53E	UH-1N	AH-1W	V-22
1 M198	I	2	1	1	2	
	II	3	1	1	2	
	III	4	1	1	2	
2 M198	I	2	2	1	2	
	II	3	2	1	2	
	III	3	2	1	2	
3 M198	I	3	3	1	2	
	II	3	3	1	2	
	III	4	3	1	2	
4 M198	I	3	4	1	2	
	II	4	4	1	2	
	III	4	4	1	2	

NOTES:
 1. CH-53D/E may be used in place of CH-46's.
 2. UH-1N and AH-1W helicopters will be used for command and control, communications retransmission, aerial observation, escort, fire support or PADS, as required.

Table F-7. Example Helicopter Wave and Serial Assignment Table.

This table provides helicopter embarkation guidance for personnel, howitzers, and ammunition in support of helicopterborne artillery raids. It is intended as an initial planning guide with exact assignments depending on mission and threat. The wave number describes the order of arrival in zone. The helo number is the number of the helicopter the howitzer/ammunition/personnel will embark on. The remarks column describes the duty of the embarked elements. The gun crew may act as the security element to alleviate the number of personnel and air support necessary for the mission.

Two Howitzers, Security Level I				
LINE #	ELEMENT	WAVE #	HELO #	REMARKS
1-3	Command	1	1	Advance Party
4-12	Support	1	1	Advance Party
49-50	Security	1	1	Advance Party
13-21	Assault	1	2	Gun Crew, Ammo Pallet(s), Howitzer
22-30	Assault	1	3	Gun Crew, Ammo Pallet(s), Howitzer
Two Howitzers, Security Level II				
LINE #	ELEMENT	WAVE #	HELO #	REMARKS
49-62	Security	1	1	Secures Position
1-3	Command	2	2	Advance Party
4-12	Support	2	2	Advance Party
13-21	Assault	2	3	Gun Crew, Ammo Pallet(s), Howitzer
22-30	Assault	2	4	Gun Crew, Ammo Pallet(s), Howitzer
Two Howitzers, Security Level III				
LINE #	ELEMENT	WAVE #	HELO #	REMARKS
1-3	Command	1	1	Advance Party
49-62	Security	1	1	Secures Position
4-12	Support	1	2	Advance Party
63-72	Security	1	3	Secures Position
13-21	Assault	2	4	Gun Crew, Ammo Pallet(s), Howitzer
22-30	Assault	2	5	Gun Crew, Ammo Pallet(s), Howitzer
Three Howitzers, Security Level I				
LINE #	ELEMENT	WAVE #	HELO #	REMARKS
1-3	Command	1	1	Advance Party
4-12	Support	1	1	Advance Party
49-50	Security	1	1	Advance Party
13-21	Assault	2	2	Gun Crew, Ammo Pallet(s), Howitzer
22-30	Assault	2	3	Gun Crew, Ammo Pallet(s), Howitzer
31-39	Assault	2	4	Gun Crew, Ammo Pallet(s), Howitzer
Three Howitzers, Security Level II				
LINE #	ELEMENT	WAVE #	HELO #	REMARKS
1-3	Command	1	1	Advance Party
49-62	Security	1	1	Secures Position
4-12	Support	1	2	Advance Party
13-21	Assault	2	3	Gun Crew, Ammo Pallet(s), Howitzer
22-30	Assault	2	4	Gun Crew, Ammo Pallet(s), Howitzer
31-39	Assault	2	5	Gun Crew, Ammo Pallet(s), Howitzer

Table F-7. Example Helicopter Wave and Serial Assignment Table (Continued).

Three Howitzers, Security Level III				
LINE #	ELEMENT	WAVE #	HELO #	REMARKS
49-62	Security	1	1	Secures Position
1-3	Command	1	2	Advance Party
4-12	Support	1	2	Advance Party
63-72	Security	1	3	Secures Position
13-21	Assault	2	4	Gun Crew, Ammo Pallet(s), Howitzer
22-30	Assault	2	5	Gun Crew, Ammo Pallet(s), Howitzer
31-39	Assault	2	5	Gun Crew, Ammo Pallet(s), Howitzer
Four Howitzers, Security Level I				
LINE #	ELEMENT	WAVE #	HELO #	REMARKS
1-3	Command	1	1	Advance Party
4-12	Support	1	1	Advance Party
49-50	Security	1	1	Advance Party
13-21	Assault	2	2	Gun Crew, Ammo Pallet(s), Howitzer*
22-30	Assault	2	3	Gun Crew, Ammo Pallet(s), Howitzer*
31-39	Assault	2	4	Gun Crew, Ammo Pallet(s), Howitzer*
40-48	Assault	2	5	Gun Crew, Ammo Pallet(s), Howitzer*
Four Howitzers, Security Level II				
LINE #	ELEMENT	WAVE #	HELO #	REMARKS
49-62	Security	1	1	Secures Position
1-3	Command	1	2	Advance Party
4-12	Support	1	2	Advance Party
13-21	Assault	2	3	Gun Crew, Ammo Pallet(s), Howitzer*
22-30	Assault	2	4	Gun Crew, Ammo Pallet(s), Howitzer*
31-39	Assault	2	5	Gun Crew, Ammo Pallet(s), Howitzer*
40-48	Assault	2	6	Gun Crew, Ammo Pallet(s), Howitzer*
Four Howitzers, Security Level III				
LINE#	ELEMENT	WAVE #	HELO #	REMARKS
1-3	Command	1	1	Advance Party
49-62	Security	1	1	Secures Position
4-12	Support	1	2	Advance Party
63-72	Security	1	2	Secures Position
13-21	Assault	2	3	Gun Crew, Ammo Pallet(s), Howitzer*
22-30	Assault	2	4	Gun Crew, Ammo Pallet(s), Howitzer*
31-39	Assault	2	5	Gun Crew, Ammo Pallet(s), Howitzer*
40-48	Assault	2	6	Gun Crew, Ammo Pallet(s), Howitzer*

* It may be necessary to divide this wave into two separate waves if the LZ does not support the simultaneous insertion of four howitzers.

#	Event/Situation	RPT	NET	From	To	Codeword	Planned Time Lines	Actual Time Lines	Remarks
1	Helo's launched								
2	Advance party in LZ								
3	LZ secured								
4	Howitzers in LZ								
5	Fire capable								
6	Fire mission complete								
7	Emergency extract								
8	MEDEVAC								
9	Force ready for extraction								
10	All forces extracted								
11	All forces recovered								
12	Abort								
13	Using alternate LZ/FP								
14	Threat contact								
15									
16									
17									
18									
19									
20									

Figure F-1. Example Raid Execution Checklist.

<p>ACCURATE TARGET LOCATION</p> <p><input type="checkbox"/> Source</p> <p><input type="checkbox"/> Accuracy</p> <p><input type="checkbox"/> Observer</p> <p><input type="checkbox"/> ACCURATE BATTERY LOCATION</p> <p><input type="checkbox"/> METEOROLOGICAL INFORMATION</p> <p><input type="checkbox"/> WEAPONS AND AMMUNITION DATA</p> <p><input type="checkbox"/> COMPUTATIONAL PROCEDURES</p> <p><input type="checkbox"/> WEATHER</p> <p><input type="checkbox"/> Astro</p> <p><input type="checkbox"/> Illumination</p> <p>TERRAIN</p> <p><input type="checkbox"/> Soil</p> <p><input type="checkbox"/> Vegetation (firing point and target)</p> <p>THREAT CAPABILITIES</p> <p><input type="checkbox"/> Counter fire</p> <p><input type="checkbox"/> AAAM</p> <p><input type="checkbox"/> EW</p> <p><input type="checkbox"/> Reaction force</p> <p>TARGET</p> <p><input type="checkbox"/> Dimensions</p> <p><input type="checkbox"/> Composition</p> <p><input type="checkbox"/> Posture</p> <p>INDIGENOUS POPULATION</p> <p><input type="checkbox"/> Proximity to firing point</p> <p><input type="checkbox"/> Proximity to target</p> <p>IMAGERY</p> <p><input type="checkbox"/> Photos</p> <p><input type="checkbox"/> Tamp/Togo</p> <p><input type="checkbox"/> Autocads</p>

Figure F-2. Example Planning Considerations Checklist.

Hasty Survey Kits	Quantity
BUCS-R with survey chip	1
BUCS-R with REV 1 chip	1
Map	1
Pizza cutter (GTA 6-5-1)	1
3-point resection device	1
Antistatic bag for BUCS-R	1
Hasty astro preplanned data: Rough data to celestial bodies Scaled data to DAP Scaled declination constant Satellite data	
XO'S handbook	1
Applicable TFT	1
Calculator	1
8-inch protractor	1
Plotting scale	1
Map case	1
Clipboards	1
Pencil/pen	2
FDC Bag	
Chart board	1
Chart paper, scaled	1
RDP	1
Pizza cutter (GTA 6-5-1)	1
Target grid	1
Chart bag	1
Map	1
FDC Brief Case	
Brief Case	1
Applicable TFT(s)	1
Applicable addendum(s)	1
Applicable GFT(s)	1
Applicable GST(s)	1
BUCS-R with REV 1 chip	1
Plotting pins	1 Box
Plotting scale	1
8-inch protractor	1
6H pencil	2
4H pencil	2
2H pencil	2
Blue pencil	2
Antistatic bag for BUCS-R	1
Map	1
Clipboards	1
Record of fire	1 Pad

Figure F-3. Example Raid Equipment List.

Gun Guide Kit	Quantity
Lensatic compass	1
Hammer	1
Stakes and tape	1 Set
Panel markers with stakes	As directed
Chem lights	As directed
Infrared strobes	As directed
Pantel stake	1
Note pad	1
Pencil/pen	2
Raid HST Kit	
Grounding rod	1
LZ marking light	1
Gloves, leatherman workman's	1 Pair
Orange vests	1
Goggles	1
Cone flashlight	2
Chem lights	As directed
Infrared strobes	As directed
Raid Mechanics Tool Bag	
Tool bag	1
Flat top screwdrivers	2
Adjustable wrench	2
Box wrenches	1 Set
Brush, cleaning	1

Figure F-3. Example Raid Equipment List (Continued).

Line	Information	Remarks
1	Mission number	
2	Location COOR/RAD/DME)	
3	Unit call sign	
4	Frequency	Primary UHF ____/FM ____ Secondary UHF ____/FM ____
5	LZ marking	
6	Wind direction/velocity	
7	Elevation/size	
8	Obstacles	
9	Friendly position (direction/distance)	
10	Threat position (direction/distance)	
11	Last fire received (time/type)	
12	Direction of fire/distance	
13	Clearance to fire (direction/distance)	
14	Approach/retirement (recommended)	
15	Personnel/equipment	
16	Other	

Figure F-4. Helicopter Landing Zone Brief.

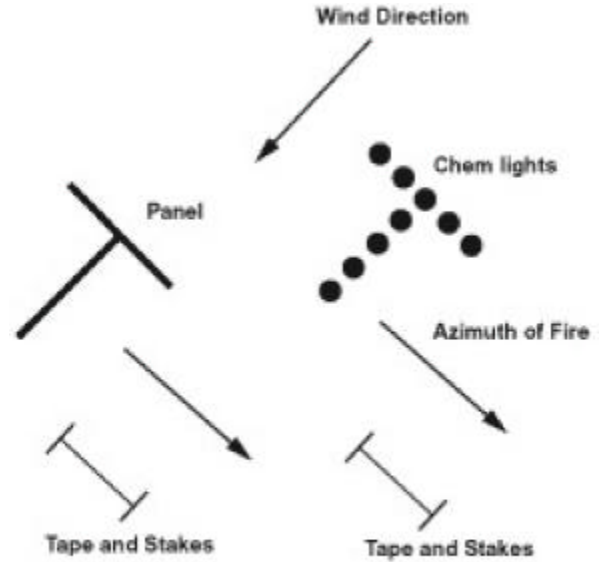

NOTE: One technique to use at night is to place red chem lights on the muzzle end of the tape and stakes and blue chem lights on the breach.

Figure F-5. Example Artillery Raid Landing

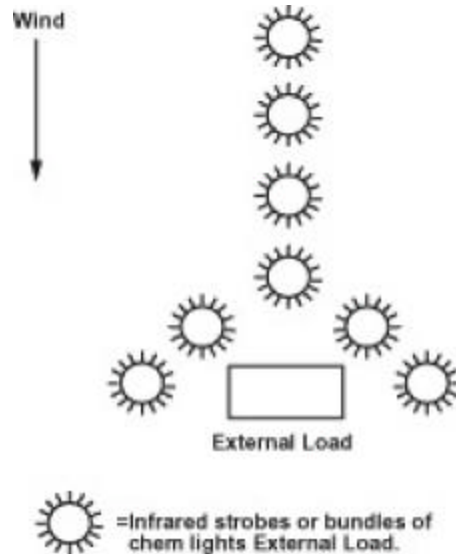

Figure F-6. Example Howitzer Pick-Up Point Lighting.

APPENDIX G

GLOSSARY

Section I. Abbreviations and Acronyms

AAA	avenues of approach	BUCS-R	backup computer system-replacement
ACE	aviation combat element	C2	command and control
ADA	air defense artillery	C3	command, control, and communications
ACON	administrative control	cpl	corporal
ADAM	area denial artillery munitions	CAS	close air support
ADAM-L	area denial artillery munitions-long duration	CBAE	commander's battlespace area evaluation
ADAM-S	area denial artillery munitions-short duration	CBR	counterbattery radar
AFATDS	Advanced Field Artillery Tactical Data System	CCIR	commander's critical information requirement
AFSC	assistant fire support coordinator	CDR	commander
ALOC	administrative and logistics operation center	CE	command element
AMAL	authorized medical allowance list	CEP	circular error probable
AMREP	ammunition report	CFFZ	call for fire zone
AO	area of operations	CFL	coordinated fire line
AoF	azimuth of fire	CFZ	critical friendly zone
AOR	area of responsibility	CG	commanding general
APICM	antipersonnel improved conventional munition	CLGP	cannon-launched guided projectile
arty	artillery	CM	corrective maintenance
ASP	ammunition supply point	CO	commanding officer
ASR	assault report request	COA	course of action
ATCCS	Army Tactical Command and Control System	COC	combat operations center
ATI	artillery target intelligence	COF	conduct of fire
ATIZ	artillery target intelligence zone	comm	communications
AXO	assistant executive officer	CP	command post
BA	basic allowance	CPREP	command post report
BAS	battalion aid station	CSB	common sensor boundary
BB	basebleed	CSMO	close station march order
BBDPICM	base-burn dual purpose improved conventional munition	CSR	controlled supply rate
BCS	battery computer system	CSS	combat service support
BDA	battle damage assessment	CSSD	combat service support detachment
BLT	battalion landing team	CSSE	combat service support element
BMP	Boevaya Mashina Pekhota	CZ	sensor zone
bn	battalion	D3A	decide, detect, deliver, and assess
BOC	battery operations center	DASC	direct air support center
Btry	battery	dig	digital
		DISREP	displacement report
		DOA	day of ammunition
		DOD	Department of Defense

DODAC	Department of Defense activity code	FSO	fire support officer
DODIC	Department of Defense identification code	FTSO	fire tactical systems officer
DOS	day of supply	FWD	forward
DP	decision point	GCE	ground combat element
DPICM	dual purpose improved conventional munition	GDU	gun display unit
DS	direct support	GPS	global positioning system
DST	decision support template	GS	general support
DTED	digital terrain elevation data	GS-R	general support-reinforcing
DTG	date-time group	GySgt	gunnery sergeant
DVST	digital voice secure telephone	HA	hide area
EEFI	essential elements of friendly information	HC	hexachloroethane (artillery smoke)
EFAT	essential field artillery task	HE	high explosive
EFST	essential fire support task	HE/Q	high explosive/ fuze quick
EOL	end of orienting line	HF	high frequency
EPW	enemy prisoner of war	HMMWV	high-mobility multipurpose wheeled vehicle
EW	electronic warfare	HOB	height of burst
FAC	forward air controller	how	howitzer
FAC (A)	forward air controller (airborne)	HPT	high-payoff target
FASCAM	family of scatterable mines	HQ	headquarters
FAX	facsimile	HST	helicopter support team
FD	fire direction	HVT	high-value target
FDC	fire direction center	ICM	improved conventional munitions
FDO	fire direction officer	ID	identification
FEBA	forward edge of the battle area	IFSAS	initial fire support automated system
FFC	force fires coordinator	illum	illumination
FFCC	force fires coordination center	IOC	intelligence operations center
FFE	fire for effect	IPB	intelligence preparation of the battlespace
FFIR	friendly forces information requirement	IR	information requirement
FFPAS	Fire Finder Position Analysis System	KIA	killed in action
FIRECAP	fire capability report	KOCSA	key terrain; observation and fields of fire; cover and concealment; obstacles; avenues of approach
FIREP	firing report	kph	kilometers per hour
FLASHREP	flash report	LAAD	low altitude air defense
FLOT	forward line of own troops	LAN	local area network
FMF	Fleet Marine Force	LAR	light armored reconnaissance
FMFM	Fleet Marine Force manual	LCU	lightweight computer unit
FO	forward observer	LD	line of departure
FPF	final protective fire	LNO	liaison officer
FPL	fire protective line	LOC	lines of communications
FSC	fire support coordinator	LOS	line of sight
FSCC	fire support coordination center	LP	listening post
FSCCL	fire support coordination line	LZ	landing zone
FSCM	fire support coordinating measure		
FSSG	force service support group		

- m meter
- MACS modular artillery charge system
- MAGTF Marine air-ground task force
- MAP mission, ammunition, position
- MAPS Modular Azimuth Positioning System
- MAW Marine aircraft wing
- MBA main battle area
- MCFSS Marine Corps Fire Support System
- MCOO modified combined obstacle overlay
- MCT maintenance contact team
- MCDP Marine Corps doctrinal publication
- MCPP Marine Corps Planning Process
- MCWP Marine Corps warfighting publication
- MDS meteorological data system
- MDSS II Marine air-ground task force (MAGTF) Deployment System II
- MEB Marine Expeditionary Brigade
- MEF Marine Expeditionary Force
- met meteorology
- METT-T mission, enemy, terrain and weather, troops and support available-time available
- MEU Marine Expeditionary Unit
- MHE material handling equipment
- MOFA multioption fuze for artillery
- MLRS multiple launch rocket system
- mm millimeter
- MMS meteorological measuring system
- MOPP mission-oriented protective posture
- MORTREP mortar report
- MOS military occupational specialty
- MPI mean point of impact
- MRE meals ready to eat
- MRL multiple rocket launcher
- MSR main supply route
- MST maintenance support team
- MT mechanical time
- MTO message to observer
- MV muzzle velocity
- MVV muzzle velocity variance

- NAI named area of interest
- NBC nuclear, biological, and chemical
- NCO noncommissioned officer
- NGF naval gunfire

- NGS national geodetic survey
- NIMA National Imagery and Mapping Agency
- NSFS naval surface fire support

- OL orienting line
- O/O on-order
- OOB order of battle
- OP observation post
- OPFAC operational facility
- OPORD operation order
- OS orienting station

- P3I pre-planned program improvement
- PA position area
- PADS position and azimuth determining system
- PCFF priority in calls for fire
- PD point detonating
- PDF principal direction of fires
- PE probable error
- PeD probable error in deflection
- PeR probable error in range
- PIAFS portable inductive artillery fuze setter
- PIBAL pilot balloon
- PIR priority intelligence requirement
- PL patrol leader
- PLGR precision lightweight global positioning system receiver
- PLRS position location reporting system
- PM preventive maintenance
- POL petroleum, oils, and lubricants
- pos position
- pvt private

- QE quadrant elevation

- R reinforcing
- RAAMS remote antiarmor mine system
- RAAMS-L remote antiarmor mine system-long duration
- RAAMS-S remote antiarmor mine system-short duration
- RAP rocket assisted projectile
- regt regiment
- rein reinforced
- RFC raid force commander
- RLT regimental landing team
- ROE rules of engagement
- RRP repair and replenishment point

R&S	reconnaissance and surveillance	TCO	tactical combat operations
RSOP	reconnaissance, selection, and occupation of position	T/E	table of equipment
RSTA	reconnaissance, surveillance, and target acquisition	tgt	target
SADARM	sense and destroy armor munition	TIO	target intelligence officer
SALUTE	size, activity, location, unit, time, and equipment	TLE	target location error
SCAR	strike coordination and reconnaissance	TM	technical manual
SCP	survey control point	TNT	trinitrotoluene
SCR	single-channel radio	T/O	table of organization
SEAD	suppression of enemy air defenses	TOF	time of flight
sec	second	TOT	time on target
SHELREP	shelling report	TPC	target processing center
SIC	survey information center	TPL	timed phase line
SITEMP	situation template	TPME	task, purpose, method, effect
SITMAP	situation map	TVA	target value analysis
SLCP	ships loading characteristics pamphlet	UAV	unmanned aerial vehicle
SMK	smoke	UHF	ultrahigh frequency
SOC	special operations capable	USMC	United States Marine Corps
SOP	standing operating procedure	USMCR	United States Marine Corps Reserve
SPEARR	security, position, establish communications, azimuth of fire, record, reconnaissance	USN	United States Navy
SPOTREP	spot report	UTM	universal transverse mercator
TACC	Marine tactical air command center	VA	vertical angle
TACC(A)	tactical air coordinator (airborne)	VE	velocity error
TAI	target area of interest	VHF	very high frequency
TAREP	target report	VT	variable time
TBMCS	theater battle management core system	WIA	wounded in action
		WP	white phosphorus
		XO	executive officer

Section II. Definitions

acquire—**1.** When applied to acquisition radars, the process of detecting the presence and location of a target in sufficient detail to permit identification. **2.** When applied to tracking radars, the process of positioning a radar beam so that a target is in that beam to permit the effective employment of weapons. See also target acquisition.

adjust fire—In artillery and naval gunfire support: **1.** An order or request to initiate an adjustment of fire. **2.** A method of control transmitted in the call for fire by the observer or spotter to indicate that he will control the adjustment. (JP 1-02)

adjustment of fire—Process used in artillery and naval gunfire to obtain correct bearing, range, and height of burst (if time fuzes are used) when engaging a target by observed fire. See also spot. (JP 1-02)

administrative control—Direction or exercise of authority over subordinate or other organizations in respect to administration and support, including organization of Service forces, control of resources and equipment, personnel management, unit logistics, individual and unit training, readiness, mobilization, demobilization, discipline, and other matters not included in the operational missions of the subordinate or other organizations. Also called ADCON. (JP 1-02)

advance party—A group of unit representatives dispatched to a planned new position in advance of the main body to prepare the position for the arrival of the unit and its equipment.

aiming circle—An optical instrument used to orient the tube of an indirect fire weapon in a desired direction. This instrument can measure both the horizontal and vertical angles.

aiming post—A striped rod used in pairs as a close-in aiming point.

air defense—All defensive measures designed to destroy attacking enemy aircraft or missiles in the Earth's envelope of atmosphere, or to nullify or reduce the effectiveness of such attack. (JP 1-02)

alternate position—The position given to a weapon, unit, or individual to be occupied when the primary position becomes untenable or unsuitable for carrying out the mission. The alternate position is located so that the unit can continue the mission it had when in its primary position.

ammunition—See munition.

ammunition report—A report used to maintain an accurate ammunition status of firing units.

angle T—In artillery and naval gunfire support, the angle formed by the intersection of the gun-target line and the observer-target line. (JP 1-02)

area fire—A volume of fire delivered in a prescribed area, generally for neutralization effects.

area of operations—An operational area defined by the joint force commander for land and naval forces. Areas of operation do not typically encompass the entire operational area of the joint force commander, but should be large enough for component commanders to accomplish their missions and protect their forces. Also called AO. (JP 1-02)

area of responsibility—**1.** The geographical area associated with a combatant command within which a combatant commander has authority to plan and conduct operations. **2.** In naval usage, a predefined area of enemy terrain for which supporting ships are responsible for covering by fire on known targets or targets of opportunity and by observation. Also called AOR. (JP 1-02)

area target—A target consisting of an area rather than a single point. (JP 1-02)

artillery fire plan—A part of the operation plan of the supported unit or force which contains the necessary information and instructions pertaining to the employment of artillery. The fire plan consists of three parts: the basic document, the target list, and schedules of fires.

artillery groupment—Temporary formations used when one unit must exercise greater control

over another unit and is inherent in a reinforcing mission. When a suitable artillery headquarters is unavailable, an artillery battalion or battery may be attached to another of like size to form an artillery groupment.

artillery preparation—Artillery fire delivered before an attack to destroy, neutralize, or suppress the enemy's defense and to disrupt communications and disorganize the enemy's defense. The preparation is planned by a direct support field artillery battalion or higher echelon in coordination with the ground commander. It is an intense volume of fire delivered in accordance with a time schedule. The fires normally commence prior to H-hour and may extend beyond it. They may start at a prescribed time or be held on call. The duration of the preparation is influenced by factors such as the fire support needs of the entire force, number of targets and firing assets, and available ammunition. (FM 101-5-1/MCRP 5-12A)

artillery target intelligence zone—An area in enemy territory that the maneuver commander wants to monitor closely. Weapon locations in this zone will be reported immediately. Their priority is exceeded only by targets in a critical friendly zone or a call-for-fire zone.

assault fire—**1.** That fire delivered by attacking troops as they close with the enemy. **2.** In artillery, extremely accurate, short-range destruction fire at point targets. (JP 1-02)

assign—**1.** To place units or personnel in an organization where such placement is relatively permanent, and/or where such organization controls and administers the units or personnel for the primary function, or greater portion of the functions, of the unit or personnel. **2.** To detail individuals to specific duties or functions where such duties or functions are primary and/or relatively permanent. See also attach. (JP 1-02)

attach—**1.** The placement of units or personnel in an organization where such placement is relatively temporary. **2.** The detailing of individuals to specific functions where such functions are secondary or relatively temporary, e.g., attached for quarters and rations; attached for flying duty. See also assign. (JP 1-02)

at my command—In artillery and naval gunfire support, the command used when it is desired to control the exact time of delivery of fire. (JP 1-02)

aviation combat element—The core element of a Marine air ground-task force (MAGTF) that is task-organized to conduct aviation operations. The aviation combat element (ACE) provides all or a portion of the six functions of Marine aviation necessary to accomplish the MAGTF's mission. These functions are antiair warfare, offensive air support, assault support, electronic warfare, air reconnaissance, and control of aircraft and missiles. The ACE is usually composed of an aviation unit headquarters and various other aviation units or their detachments. It can vary in size from a small aviation detachment of specifically required aircraft to one or more Marine aircraft wings. The ACE itself is not a formal command. Also called ACE. (JP 1-02)

azimuth of fire—The direction, expressed in mils, that a battery is laid (oriented) on when it occupies a position.

backup computer system—A hand-held computer used as the primary backup to the battery computer system.

barrage fire—Fire which is designed to fill a volume of space or area rather than aimed specifically at a given target. See also fire. (JP 1-02)

base-ejection shell—A type of projectile that ejects its payload from the base, such as the improved conventional munition projectile.

basic load—The quantity of supplies required to be on hand within, and which can be moved by, a unit or formation. It is expressed according to the wartime organization of the unit or formation and maintained at the prescribed levels. (JP 1-02)

basic load of ammunition—The amount of ammunition a unit is authorized to maintain to initiate combat and sustain itself until resupplied.

battery center—A point on the ground, the coordinates of which are used as a reference indicating the location of the battery in the production of firing data. Also called chart location of the battery. (JP 1-02)

battery computer system—An automated data processing system located in the firing battery. Consists of three major components: lightweight computer unit, power distribution unit, and 1 to 12 gun display units. Used to compute accurate firing data and as a digital communications interface.

battery operations center—A facility established to serve as an alternate fire direction center and as the battery command post.

blood agent—A chemical compound, including the cyanide group, that affects bodily functions by preventing the normal utilization of oxygen by body tissues. (JP 1-02)

boresighting—The process by which the optical axes of the weapon sights are aligned parallel to the axis of the cannon tube. The primary methods of boresighting are the distant aiming point, the testing target, or standard angle. Boresight is verified with the M140/M139 alignment device.

caliber—**1.** The diameter of the bore of a weapon; obtained in rifled weapons by measuring between opposite lands. **2.** Diameter of a projectile. **3.** Unit of measure used to express the length of the bore of a weapon. The number of calibers is determined by dividing the length of the bore of the weapon (from breech face of the tube to the muzzle) by the diameter of its bore.

call for fire—A request for fire containing data necessary for obtaining the required fire on a target. (JP 1-02)

call-for-fire zone—An area in enemy territory that the maneuver commander considers extremely important to neutralize fires from by immediate counterfire. (FM 6-121)

cancel—In artillery and naval gunfire support, the term, “cancel,” when coupled with a previous order, other than an order for a quantity or type of ammunition, rescinds that order. (JP 1-02)

cancel check firing—The order to rescind check firing. (JP 1-02)

cannot observe—A type of fire control which indicates that the observer or spotter will be unable to adjust fire, but believes a target exists at the given location and is of sufficient importance to justify firing upon it without adjustment or observation. (JP 1-02)

cease fire—A command given to air defense artillery units to refrain from firing on, but to continue to track, an airborne object Missiles already in flight will be permitted to continue to intercept. (JP 1-02)

cease loading—In artillery and naval gunfire support, the command used during firing of two or more rounds to indicate the suspension of inserting rounds into the weapon. (JP 1-02)

centers of gravity—Those characteristics, capabilities, or localities from which a military force derives its freedom of action, physical strength, or will to fight. (JP 1-02)

centigray—A unit of absorbed dose of radiation (one centigray equals one rad). The term centigray (1/100 of a gray) (one gray equals 100 rads) has replaced the term rad and is the equivalent of one rad. Also called a cGy.

charge—**1.** The amount of propellant required for a fixed, semi-fixed, or separate loading projectile, round or shell. It may also refer to the quantity of explosive filling contained in a bomb, mine or the like. **2.** In combat engineering, a quantity of explosive, prepared for demolition purposes. (JP 1-02)

check firing—In artillery and naval gunfire support, a command to cause a temporary halt in firing. (JP 1-02)

checkpoint—**1.** A predetermined point on the surface of the Earth used as a means of controlling movement, a registration target for fire adjustment, or reference for location. **2.** Center of impact; a burst center. **3.** Geographical location on land or water above which the position of an aircraft in flight may be determined by observation or by electrical means. **4.** A place where military police check vehicular or pedestrian traffic in order to enforce circulation control measures and other laws, orders, and regulations. (JP 1-02)

chemical agent—A chemical substance which is intended for use in military operations to kill, seriously injure, or incapacitate personnel through its physiological effects. The term excludes riot control agents, herbicides, smoke, and flame.

chemical defense—The methods, plans and procedures involved in establishing and executing defensive measures against attack utilizing chemical agents. See also NBC defense. (JP 1-02)

chemical dose—The amount of chemical agent, expressed in milligrams, that is taken or absorbed by the body. (JP 1-02)

circular error probable—An indicator of the delivery accuracy of a weapon system, used as a factor in determining probable damage to a target. It is the radius of a circle within which half of a missile's projectiles are expected to fall. Also called CEP. (JP 1-02)

close column—A convoy in which vehicles move at intervals of less than 100 meters.

close support—That action of the supporting force against targets or objectives which are sufficiently near the supported force as to require detailed integration or coordination of the supporting action with the fire, movement, or other actions of the supported force. See also direct support; general support; mutual support; support. (JP 1-02)

close supporting fire—Fire placed on enemy troops, weapons, or positions which, because of their proximity, present the most immediate and serious threat to the supported unit. See also supporting fire. (JP 1-02)

collective call sign—Any call sign which represents two or more facilities, commands, authorities, or units. The collective call sign for any of these includes the commander thereof and all subordinate commanders therein. See also call sign. (JP 1-02)

collocation—The physical placement of two or more detachments, units, organizations, or facilities at a specifically defined location. (JP 1-02)

combat power—The total means of destructive and/or disruptive force which a military unit/formation can apply against the opponent at a given time. (JP 1-02)

combat service support—The essential capabilities, functions, activities, and tasks necessary to sustain all elements of operating forces in theater at all levels of war. Within the national and theater logistic systems, it includes but is not limited to that support rendered by service forces in ensuring the aspects of supply, maintenance, transportation, health services, and other services required by aviation and ground combat troops to permit those units to accomplish their missions in combat. Combat service support encompasses those activities at all levels of war that produce sustainment to all operating forces on the battlefield. (JP 1-02) Also called CSS.

combat service support element—The core element of a Marine air-ground task force (MAGTF) that is task-organized to provide the combat service

support necessary to accomplish the MAGTF mission. The combat service support element varies in size from a small detachment to one or more force service support groups. It provides supply, maintenance, transportation, general engineering, health services, and a variety of other services to the MAGTF. The combat service support element itself is not a formal command. Also called CSSE. (JP 1-02)

command—**1.** The authority that a commander in the Armed Forces lawfully exercises over subordinates by virtue of rank or assignment. Command includes the authority and responsibility for effectively using available resources and for planning the employment of, organizing, directing, coordinating, and controlling military forces for the accomplishment of assigned missions. It also includes responsibility for health, welfare, morale, and discipline of assigned personnel. **2.** An order given by a commander; that is, the will of the commander expressed for the purpose of bringing about a particular action. **3.** A unit or units, an organization, or an area under the command of one individual. (JP 1-02)

command and control—The exercise of authority and direction by a properly designated commander over assigned and attached forces in the accomplishment of the mission. Command and control functions are performed through an arrangement of personnel, equipment, communications, facilities, and procedures employed by a commander in planning, directing, coordinating, and controlling forces and operations in the accomplishment of the mission. Also called C2. (JP 1-02)

command and control system—The facilities, equipment, communications, procedures, and personnel essential to a commander for planning, directing, and controlling operations of assigned forces pursuant to the missions assigned. (JP 1-02)

command element—The core headquarters element of a Marine air-ground task force (MAGTF). The command element is composed of the commander, general or executive and special staff sections, headquarters section, and requisite

communications support, intelligence, and reconnaissance forces necessary to accomplish the MAGTF mission. The command element provides command and control, intelligence, and other support essential for effective planning and execution of operations by the other elements of the MAGTF. The command element varies in size and composition. Also called CE. (JP 1-02)

commander's estimate of the situation—A logical process of reasoning by which a commander considers all the circumstances affecting the military situation and arrives at a decision as to a course of action to be taken to accomplish the mission. A commander's estimate which considers a military situation so far in the future as to require major assumptions is called a commander's long-range estimate of the situation. (JP 1-02)

command post—A unit's or subunit's headquarters where the commander and the staff perform their activities. In combat, a unit's or subunit's headquarters is often divided into echelons; the echelon in which the unit or subunit commander is located or from which such commander operates is called a command post. Also called CP. (JP 1-02)

command post report—A report used to report the time of opening and closing of the command post and the location of the new command post.

common control (artillery)—Horizontal and vertical map or chart location of points in the target area and position area, tied in with the horizontal and vertical control in use by two or more units. May be established by firing, survey, or combination of both, or by assumption. (JP 1-02)

common grid—A common grid is the sum of all components of relative survey, as well as the geodetic system, coordinate system, and the projection/grid system of the operational area. Through these components all fire support and targeting assets are oriented the same, to prescribed accuracies, with respect to azimuth, position, and elevation. (JP 1-02)

common sensory boundary—A line established by the division artillery or field artillery brigade that divides target acquisition areas of search into close and deep areas for the AN/TPQ-36 and AN/TPQ-37 respectively. This boundary is established to prevent target duplication and maximize range capabilities of the radars.

complete round—A term applied to an assemblage of explosive and nonexplosive components designed to perform a specific function at the time and under the conditions desired. Examples of complete rounds of ammunition are: a. separate loading, consisting of a primer, propelling charge and, except for blank ammunition, a projectile and a fuze; b. fixed or semi-fixed, consisting of a primer, propelling charge, cartridge case, a projectile and, except when solid projectiles are used, a fuze; c. bomb, consisting of all component parts required to drop and function the bomb once; d. missile, consisting of a complete warhead section and a missile body with its associated components and propellants; and e. rocket, consisting of all components necessary to function. (JP 1-02)

concentrated fire—Fire from a number of weapons directed at a single point or small area. In Marine artillery, the term massed fire is synonymous with concentrated fire.

concept of operations—A verbal or graphic statement, in broad outline, of a commander's assumptions or intent in regard to an operation or series of operations. The concept of operations frequently is embodied in campaign plans and operation plans; in the latter case, particularly when the plans cover a series of connected operations to be carried out simultaneously or in succession. The concept is designed to give an overall picture of the operation. It is included primarily for additional clarity of purpose. (JP 1-02)

contingent zone of fire—An area within which a designated ground unit or fire support ship may be called upon to deliver fire. See also zone of fire. (JP 1-02)

continuity of operations—The degree or state of being continuous in the conduct of functions, tasks, or duties necessary to accomplish a military action or mission in carrying out the national military strategy. It includes the functions and duties of the commander, as well as the supporting functions and duties performed by the staff and others acting under the authority and direction of the commander.

continuous fire—**1.** Fire conducted at a normal rate without interruption for application of adjustment corrections or for other causes. **2.** In field artillery and naval gunfire support, loading and firing at a specified rate or as rapidly as possible consistent with accuracy within the prescribed rate of fire for the weapon. Firing will continue until terminated by the command "end of mission" or temporarily suspended by the command "cease loading" or "check firing." (JP 1-02)

continuous illumination fire—A type of fire in which illuminating projectiles are fired at specified time intervals to provide uninterrupted lighting on the target or specified area. (JP 1-02)

control—**1.** Authority which may be less than full command exercised by a commander over part of the activities of subordinate or other organizations. **2.** In mapping, charting, and photogrammetry, a collective term for a system of marks or objects on the Earth or on a map or a photograph, whose positions or elevations, or both, have been or will be determined. **3.** Physical or psychological pressures exerted with the intent to assure that an agent or group will respond as directed. **4.** An indicator governing the distribution and use of documents, information, or material. Such indicators are the subject of intelligence community agreement and are specifically defined in appropriate regulations. See also administrative control; operational control; tactical control. (JP 1-02)

converged sheaf—The lateral distribution of fire of two or more pieces so that the planes of fire intersect at a given point. See also open sheaf; parallel sheaf; special sheaf. (JP 1-02)

convoy—**1.** A number of merchant ships or naval auxiliaries, or both, usually escorted by warships and/or aircraft, or a single merchant ship or naval auxiliary under surface escort, assembled and organized for the purpose of passage together. **2.** A group of vehicles organized for the purpose of control and orderly movement with or without escort protection. (JP 1-02)

counterbattery fire—Fire delivered for the purpose of destroying or neutralizing indirect fire weapon systems. (JP 1-02)

counterfire—Fire intended to destroy or neutralize enemy weapons (DOD only) Includes counterbattery, counterbombardment, and countermortar fire. See also fire. (JP 1-02)

counterfire reference grid—A series of 5-kilometer squares covering a zone of action used to rapidly orient target acquisition assets and firing units to a target area.

counterintelligence—Information gathered and activities conducted to protect against espionage, other intelligence activities, sabotage, or assassinations conducted by or on behalf of foreign governments or elements thereof, foreign organizations, or foreign persons, or international terrorist activities. Also called CI. (JP 1-02)

countermechanized fire—Fire delivered against active enemy mechanized units.

countermortar fire—Fire especially directed against enemy mortars.

counterpreparation fire—Intensive prearranged fire delivered when the imminence of the enemy attack is discovered. (DOD only) It is designed to: break up enemy formations; disorganize the enemy's systems of command, communications, and observation; decrease the effectiveness of

artillery preparation; and impair the enemy's offensive spirit. See also fire. (JP 1-02)

course of action—**1.** A plan that would accomplish, or is related to, the accomplishment of a mission. **2.** The scheme adopted to accomplish a task or mission. It is a product of the Joint Operation Planning and Execution System concept development phase. The supported commander will include a recommended course of action in the commander's estimate. The recommended course of action will include the concept of operations, evaluation of supportability estimates of supporting organizations, and an integrated time-phased data base of combat, combat support, and combat service support forces and sustainment. Refinement of this data base will be contingent on the time available for course of action development. When approved, the course of action becomes the basis for the development of an operation plan or operation order. Also called COA. (JP 1-02)

covering fire—**1.** Fire used to protect troops when they are within range of enemy small arms. **2.** In amphibious usage, fire delivered prior to the landing to cover preparatory operations such as underwater demolition or minesweeping. See also fire. (JP 1-02)

crater analysis—Process by which the direction to an artillery or mortar unit is determined from analysis of the shell crater. Additionally, shell fragments are collected to determine the type of shell that caused the crater.

crest—A terrain feature of such altitude that it restricts fire or observation in an area beyond, resulting in dead space, or limiting the minimum elevation, or both. (JP 1-02)

critical friendly zone—An area in which are located friendly units or units that the maneuver commander designates as critical.

cueing—External actions or inputs that cause a surveillance or target acquisition device to turn on and search a suspect area.

damage assessment—**1.** The determination of the effect of attacks on targets (DOD only) **2.** A determination of the effect of a compromise of classified information on national security. (JP 1-02)

danger close—In artillery and naval gunfire support, information in a call for fire to indicate that friendly forces are within 600 meters of the target.

dead space—**1.** An area within the maximum range of a weapon, radar, or observer, which cannot be covered by fire or observation from a particular position because of intervening obstacles, the nature of the ground, or the characteristics of the trajectory, or the limitations of the pointing capabilities of the weapons. **2.** An area or zone which is within range of a radio transmitter, but in which a signal is not received. **3.** The volume of space above and around a gun or guided missile system into which it cannot fire because of mechanical or electronic limitations. (JP 1-02)

deep supporting fire—Fire directed on objectives not in the immediate vicinity of our forces, for neutralizing and destroying enemy reserves and weapons, and interfering with enemy command, supply, communications, and observations. See also close supporting fire; direct supporting fire; supporting fire. (JP 1-02)

deliberate occupation—The occupation of a position by a unit that has been fully prepared for occupation by the advance party; for example, howitzer positions have been selected and initial deflections provided to the gun guides.

destruction—A type of adjustment for destroying a given target. (JP 1-02)

destruction fire—Fire delivered for the sole purpose of destroying material objects. See also fire. (JP 1-02)

destruction fire mission—In artillery, fire delivered for the purpose of destroying a point target. See also fire. (JP 1-02)

detachment—**1.** A part of a unit separated from its main organization for duty elsewhere. **2.** A

temporary military or naval unit formed from other units or parts of units. (JP 1-02)

direct air support center—The principal air control agency of the US Marine air command and control system responsible for the direction and control of air operations directly supporting the ground combat element. It processes and coordinates requests for immediate air support and coordinates air missions requiring integration with ground forces and other supporting arms. It normally collocates with the senior fire support coordination center within the ground combat element and is subordinate to the tactical air command center. Also called DASC. (JP 1-02)

direct fire—Gunfire delivered on a target, using the target itself as a point of aim for either the gun or the director. (JP 1-02)

direct support—A mission requiring a force to support another specific force and authorizing it to answer directly the supported force's request for assistance. See also close support; general support; mutual support; support. (JP 1-02)

direct support artillery—Artillery whose primary task is to provide fire requested by the supported unit. (JP 1-02)

direct supporting fire—Fire delivered in support of part of a force, as opposed to general supporting fire which is delivered in support of the force as a whole. See also close supporting fire; deep supporting fire; supporting fire. (JP 1-02)

dispersion—**1.** A scattered pattern of hits around the mean point of impact of bombs and projectiles dropped or fired under identical conditions. **2.** In anti-aircraft gunnery, the scattering of shots in range and deflection about the mean point of explosion. **3.** The spreading or separating of troops, materiel, establishments, or activities which are usually concentrated in limited areas to reduce vulnerability. **4.** In chemical and biological operations, the dissemination of agents in liquid or aerosol form. **5.** In airdrop operations, the scatter of personnel and/or cargo on the drop zone. **6.** In naval control of shipping, the reberthing of a ship

in the periphery of the port area or in the vicinity of the port for its own protection in order to minimize the risk of damage from attack. (JP 1-02)

displacement—**1.** The act of leaving a position before occupying another. **2.** The undesired movement of a sight caused by traversing the tube or by the shock of firing.

displacement report—A report used to report the displacement of a firing battery or element. The DISREP is submitted when the unit can no longer fire from its present position due to displacement.

distant aiming point—An aiming point at least 1,500 meters from the pieces.

distributed fire—Fire so dispersed as to engage most effectively an area target. See also fire. (JP 1-02)

distribution of fire—The pattern of bursts in the target area; the sheaf.

doctrine—Fundamental principles by which the military forces or elements thereof guide their actions in support of national objectives. It is authoritative but requires judgment in application. (JP 1-02)

dud—Explosive munition which has not been armed as intended or which has failed to explode after being armed. (JP 1-02)

electronic line of sight—A straight, unobstructed path from the transmit antenna of an emitter to either a reflecting object or a receive antenna.

emergency mission—Mission occupying a position, from the march, in response to a call for fire, without prior reconnaissance or preparation of the position. See also hip shoot.

end of mission—In artillery and naval gunfire support, an order given to terminate firing on a specific target. (JP 1-02)

end of orienting line—A point on the orienting line marked by any sharply defined permanent or semipermanent object such as a steeple, flag-pole, or stake. It should be visible during darkness.

explosive ordnance—All munitions containing explosives, nuclear fission or fusion materials, and biological and chemical agents. This includes bombs and warheads; guided and ballistic missiles; artillery, mortar, rocket, and small arms ammunition; all mines, torpedoes, and depth charges; demolition charges; pyrotechnics; clusters and dispensers; cartridge and propellant actuated devices; electro-explosive devices; clandestine and improvised explosive devices; and all similar or related items or components explosive in nature. (JP 1-02)

field storage location—A controlled, limited-access area in which a unit having custody of nuclear weapons stores them. Its primary purpose is to prevent unauthorized and uncontrolled access to the weapons.

final protective fire—An immediately available pre-arranged barrier of fire designed to impede enemy movement across defensive lines or areas. (JP 1-02)

fire—**1.** The command given to discharge a weapon(s). **2.** To detonate the main explosive charge by means of a firing system. See also barrage fire; close supporting fire; concentrated fire; counterfire; counterpreparation fire; covering fire; deep supporting fire; destruction fire; direct fire; direct supporting fire; distributed fire; grazing fire; harassing fire; indirect fire; interdiction fire; neutralization fire; observed fire; radar fire; registration fire; scheduled fire; searching fire; supporting fire; suppressive fire; unobserved fire; zone fire. (JP 1-02)

fire capabilities chart—A chart, usually in the form of an overlay, showing the areas which can be reached by the fire of the bulk of the weapons of a unit. (JP 1-02)

fire capability report—A report providing the firing status of an artillery battery or element. The report is made when a unit occupies a new firing position and is ready to fire, or when a change occurs in the number of weapons available (e.g., a gun out of action due to enemy action or a mechanical malfunction).

fire control—The control of all operations in connection with the application of fire on a target. (JP 1-02)

fire control alignment tests—Tests performed to determine if the on-carriage fire control equipment, the gunner's quadrant, and the alignment device are in correct adjustment

fire control radar—Radar used to provide target information inputs to a weapon fire control system. (JP 1-02)

fire control system—A group of interrelated fire control equipment and/or instruments designed for use with a weapon or group of weapons. (JP 1-02)

fire direction center—That element of a command post, consisting of gunnery and communication personnel and equipment, by means of which the commander exercises fire direction and/or fire control. The fire direction center receives target intelligence and requests for fire, and translates them into appropriate fire direction. (JP 1-02)

fire for effect—**1.** Fire which is delivered after the mean point of impact or burst is within the desired distance of the target or adjusting/ranging point. **2.** Term in a call for fire to indicate the adjustment/ranging is satisfactory and fire for effect is desired. (JP 1-02)

fire mission—**1.** Specific assignment given to a fire unit as part of a definite plan. **2.** Order used to alert the weapon/battery area and indicate that the message following is a call for fire. (JP 1-02)

fire planning—The planning conducted by each supporting arm agency in response to the supported commander's fire support plan.

Establishing essential tasks and a scheme of fires, scheduling of fires, provisions for attacking targets of opportunity, positioning of firing elements and observers, communications, combat service support, and computation of firing data (as applicable) are some of the aspects involved in fire planning.

firepower—**1.** The amount of fire which may be delivered by a position, unit, or weapon system. **2.** Ability to deliver fire. (JP 1-02)

fire support coordination center—A single location in which are centralized communications facilities and personnel incident to the coordination of all forms of fire support. (JP 1-02)

fire support coordinator—The officer in charge of the fire support coordination center and is the direct representative of the commander, landing force for the planning and coordination of all available fire support.

fire support plan—The fire support plan is a tactical plan prepared by the FSC, containing the necessary information for the employment of fire support in the operation. It consists of the concept of fires, essential fire support tasks (EFST), and the scheme of fires.

firing chart—Map, photo map, or grid sheet showing the relative horizontal and vertical positions of batteries, base points, base point lines, check points, targets, and other details needed in preparing firing data. (JP 1-02)

firing point—That point in the firing circuit where the device employed to initiate the detonation of the charges is located. (JP 1-02)

firing position—A specific location occupied or to be occupied by the firing battery or element.

formations—Weapons emplacement in a position area as selected by the battery commander.

forward air controller (airborne)—A specifically trained and qualified aviation officer who exercises control from the air of aircraft engaged in close air support of ground troops. The forward air

controller (airborne) is normally an airborne extension of the tactical air control party. Also called FAC(A). (JP 1-02)

forward line of own troops—A line which indicates the most forward positions of friendly forces in any kind of military operation at a specific time. The forward line of own troops normally identifies the forward location of covering and screening forces. Also called FLOT. (JP 1-02)

forward observer—An observer operating with front line troops and trained to adjust ground or naval gunfire and pass back battlefield information. In the absence of a forward air controller, the observer may control close air support strikes. (JP 1-02)

general support—That support which is given to the supported force as a whole and not to any particular subdivision thereof. See also close support; direct support; support. (JP 1-02)

general support artillery—Artillery which executes the fire directed by the commander of the unit to which it organically belongs or is attached. It fires in support of the operation as a whole rather than in support of a specific subordinate unit. (JP 1-02)

general support-reinforcing—A tactical artillery mission. General support-reinforcing artillery has the mission of supporting the force as a whole and of providing reinforcing fires for another artillery unit. (JP 1-02)

grazing fire—Fire approximately parallel to the ground where the center of the cone of fire does not rise above one meter from the ground. See also fire. (JP 1-02)

ground combat element—The core element of a Marine air-ground task force (MAGTF) that is task-organized to conduct ground operations. It is usually constructed around an infantry organization but can vary in size from a small ground unit of any type, to one or more Marine divisions that can be independently maneuvered under the direction of the MAGTF commander. The ground

combat element itself is not a formal command. Also called GCE. (JP 1-02)

gun—**1.** A cannon with relatively long barrel, operating with relatively low angle of fire, and having a high muzzle velocity. **2.** A cannon with tube length 30 calibers or more. See also howitzer. (JP 1-02)

gun carriage—A mobile or fixed support for a gun. It sometimes includes the elevating and traversing mechanisms.

gun-target line—An imaginary straight line from gun to target. (JP 1-02)

hang fire—A malfunction that causes an undesired delay in the functioning of a firing system. (JP 1-02)

harassing fire—Fire designed to disturb the rest of the enemy troops, to curtail movement, and, by threat of losses, to lower morale. See also fire. (JP 1-02)

hasty defense—A defense normally organized while in contact with the enemy or when contact is imminent and time available for the organization is limited. It is characterized by improvement of the natural defensive strength of the terrain by utilization of foxholes, emplacements, and obstacles. (JP 1-02)

hasty occupation—The occupation of a position that has not been fully prepared for occupation by the advance party.

hasty survey—Techniques used to establish rapid and sufficiently accurate direction and/or position data through simplified procedures and with cannon battery table of equipment and equipment.

high angle fire—Fire delivered at angles of elevation greater than the elevation that corresponds to the maximum range of the gun and ammunition concerned; fire, the range of which decreases as the angle of elevation is increased. (JP 1-02)

high-payoff target—A target whose loss to the enemy will significantly contribute to the success of the friendly course of action. High-payoff targets are those high-value targets, identified through wargaming, which must be acquired and successfully attacked for the success of the friendly commander's mission. Also called HPT. (JP 1-02)

high-value target—A target the enemy commander requires for the successful completion of the mission. The loss of high-value targets would be expected to seriously degrade important enemy functions throughout the friendly commander's area of interest. Also called HVT. (JP 1-02)

hip shoot—Occupying a position from a convoy without prior reconnaissance and firing from this position in response to a call for fire.

howitzer—**1.** A cannon which combines certain characteristics of guns and mortars. The howitzer delivers projectiles with medium velocities, either by low or high trajectories. **2.** Normally a cannon with a tube length of 20 to 30 calibers; however, the tube length can exceed 30 calibers and still be considered a howitzer when the high angle fire zoning solution permits range overlap between charges. See also gun. (JP 1-02)

illumination fire—Fire designed to illuminate an area. Illumination fire is used to observe enemy operations and movements, to adjust observed fire during hours of darkness, and to provide assistance to friendly night operations.

immediate counterfire—The attack of the enemy's indirect fire systems that are inflicting heavy damage on friendly forces.

indirect fire—Fire delivered on a target that is not itself used as a point of aim for the weapons or the director. (JP 1-02)

infiltration—**1.** The movement through or into an area or territory occupied by either friendly or enemy troops or organizations. The movement is made, either by small groups or by individuals, at extended or irregular intervals. When used in

connection with the enemy, it infers that contact is avoided. **2.** In intelligence usage, placing an agent or other person in a target area in hostile territory. Usually involves crossing a frontier or other guarded line. Methods of infiltration are: black (clandestine); grey (through legal crossing point but under false documentation); white (legal). (JP 1-02)

intelligence preparation of the battlespace—An analytical methodology employed to reduce uncertainties concerning the enemy, environment, and terrain for all types of operations. Intelligence preparation of the battlespace builds an extensive data base for each potential area in which a unit may be required to operate. The data base is then analyzed in detail to determine the impact of the enemy, environment, and terrain on operations and presents it in graphic form. Intelligence preparation of the battlespace is a continuing process. Also called IPB. (JP 1-02)

interdiction fire—Fire placed on an area or point to prevent the enemy from using the area or point. (NATO, AAP-6)

Joint Munitions Effectiveness Manual-Special Operations—A publication providing a single, comprehensive source of information covering weapon effectiveness, selection, and requirements for special operations munitions. In addition, the closely related fields of weapon characteristics and effects, target characteristics, and target vulnerability are treated in limited detail required by the mission planner. Although emphasis is placed on weapons that are currently in the inventory, information is also included for some weapons not immediately available but projected for the near future. Also called JMEM-SO.

killing zone—An area in which a commander plans to force the enemy to concentrate so as to destroy him with conventional weapons or the tactical employment of nuclear weapons. (JP 1-02)

laid—A weapon is laid when the axis of the tube is accurately aimed in a predetermined direction.

laser range finder—A device which uses laser energy for determining the distance from the device to a place or object. (JP 1-02)

lateral spread—A technique used to place the mean point of impact of two or more units 100 meters apart on a line perpendicular to the gun-target line. (JP 1-02)

laying—The process of orienting a weapon for direction.

list of targets—A tabulation of confirmed or suspect targets maintained by any echelon for informational and fire support planning purposes. See also target list. (JP 1-02)

lot—Specifically, a quantity of material all of which was manufactured under identical conditions and assigned an identifying lot number. (JP 1-02)

low angle fire—Fire delivered at angles of elevation below the elevation that corresponds to the maximum range of the gun and ammunition concerned. (JP 1-02)

Marine air-ground task force—The Marine Corps principal organization for all missions across the range of military operations, composed of forces task-organized under a single commander capable of responding rapidly to a contingency anywhere in the world. The types of forces in the Marine air-ground task force (MAGTF) are functionally grouped into four core elements: a command element, an aviation combat element, a ground combat element, and a combat service support element. The four core elements are categories of forces, not formal commands. The basic structure of the MAGTF never varies, though the number, size, and type of Marine Corps units comprising each of its four elements will always be mission dependent. The flexibility of the organizational structure allows for one or more subordinate MAGTFs to be assigned. Also called MAGTF. See also aviation combat element; combat service support element; command element; ground combat element; Marine expeditionary force; Marine expeditionary force (forward); Marine expedi-

tionary unit; special purpose Marine air-ground task force; task force. (JP 1-02)

main battle area—That portion of the battlefield in which the decisive battle is fought to defeat the enemy. For any particular command, the main battle area extends rearward from the forward edge of the battle area to the rear boundary of the command's subordinate units. (JP 1-02)

maneuver—**1.** A movement to place ships or aircraft in a position of advantage over the enemy. **2.** A tactical exercise carried out at sea, in the air, on the ground, or on a map in imitation of war. **3.** The operation of a ship, aircraft, or vehicle, to cause it to perform desired movements. **4.** Employment of forces on the battlefield through movement in combination with fire, or fire potential, to achieve a position of advantage in respect to the enemy in order to accomplish the mission. (JP 1-02)

mark—In artillery and naval gunfire support, to call for fire on a specified location in order to orient the observer/spotter, to indicate targets, or to report the instant of optimum light on the target produced by illumination shells. In naval operations, to use a maritime unit to maintain an immediate offensive or obstructive capability against a specified target.

marking fire—Fire placed on a target for the purpose of identification. (JP 1-02)

mass—**1.** The concentration of combat power. **2.** The military formation in which units are spaced at less than the normal distances and intervals. (JP 1-02)

maximum rate of fire—The rate of fire that a weapon can continue for a short period without seriously overheating.

meteorological data—Meteorological facts pertaining to the atmosphere, such as wind, temperature, air density, and other phenomena which affect military operations. (JP 1-02)

mil—A unit of measurement for angles. There are 6400 mils in a complete circle.

misfire—**1.** Failure to fire or explode properly. **2.** Failure of a primer or the propelling charge of a round or projectile to function wholly or in part. (JP 1-02)

mission—**1.** The task, together with the purpose, that clearly indicates the action to be taken and the reason therefore. **2.** In common usage, especially when applied to lower military units, a duty assigned to an individual or unit; a task. **3.** The dispatching of one or more aircraft to accomplish one particular task. (JP 1-02)

mission-essential materiel—**1.** That materiel which is authorized and available to combat, combat support, combat service support, and combat readiness training forces to accomplish their assigned missions. **2.** For the purpose of sizing organic industrial facilities, that Service-designated materiel authorized to combat, combat support, combat service support, and combat readiness training forces and activities, including Reserve and National Guard activities, which is required to support approved emergency and/or war plans, and where the materiel is used to: a. destroy the enemy or his capacity to continue war; b. provide battlefield protection of personnel; c. communicate under war conditions; d. detect, locate, or maintain surveillance over the enemy; e. provide combat transportation and support of men and materiel; and f. support training functions, but is suitable for employment under emergency plans to meet purposes enumerated above. (JP 1-02)

Multiple Launch Rocket System—The Multiple Launch Rocket System is a highly mobile, rapid-fire, surface-to-surface, free-flight rocket and guided missile system. It is designed to complement cannon artillery; to attack the enemy deep; and to strike at counterfire, air defense, and high-payoff targets. Also called MLRS.

munition—A complete device charged with explosives, propellants, pyrotechnics, initiating composition, or nuclear, biological, or chemical material for use in military operations, including demolitions. Certain suitably modified munitions

can be used for training, ceremonial or nonoperational purposes. Also called ammunition (Note: In common usage, “munitions” (plural) can be military weapons, ammunition, and equipment) See also explosive ordnance. (JP 1-02)

muzzle velocity—The velocity of a projectile with respect to the muzzle at the instant the projectile leaves the weapon. (JP 1-02)

naval surface fire support—Fire provided by Navy surface gun, missile, and electronic warfare systems in support of a unit or units tasked with achieving the commander’s objectives. Also called NSFS. (JP 1-02)

NBC defense—Defensive measures that enable friendly forces to survive, fight, and win against enemy use of nuclear, biological, or chemical (NBC) weapons and agents. US forces apply NBC defensive measures before and during integrated warfare. In integrated warfare, opposing forces employ nonconventional weapons along with conventional weapons (NBC weapons are nonconventional). (JP1-02)

nerve agent—A potentially lethal chemical agent which interferes with the transmission of nerve impulses. (JP 1-02)

net call sign—A call sign which represents all stations within a net. (JP 1-02)

neutralization fire—Fire which is delivered to render the target ineffective or unusable. See also fire. (JP 1-02)

neutralize—As pertains to military operations, to render ineffective or unusable. (JP 1-02)

objective—The physical object of the action taken; e.g., a definite tactical feature, the seizure and/or holding of which is essential to the commander’s plan. See also target. (JP 1-02)

objective area—A defined geographical area within which is located an objective to be captured or reached by the military forces. This area is defined by competent authority for purposes of command and control. (JP 1-02)

obscuration fire—Fire delivered to suppress the enemy by obscuring their view of the battlefield.

observed fire—Fire for which the point of impact or burst can be seen by an observer. The fire can be controlled and adjusted on the basis of observation. See also fire. (JP 1-02)

observer-target line—An imaginary straight line from the observer/spotter to the target. (JP 1-02)

on-call—**1.** A term used to signify that a prearranged concentration, air strike, or final protective fire may be called for. **2.** Preplanned, identified force or materiel requirements without designated time-phase and destination information. Such requirements will be called forward upon order of competent authority. See also call for fire. (JP 1-02)

on-call target—In artillery and naval gunfire support, a planned target other than a scheduled target on which fire is delivered when requested. (JP 1-02)

open column—A convoy in which vehicles move at intervals of 100 meters.

open sheaf—The lateral distribution of the fire of two or more pieces so that adjoining points of impact or points of burst are separated by the maximum effective width of burst of the type shell being used. See also converged sheaf; parallel sheaf; special sheaf. (JP 1-02)

operational control—Transferable command authority that may be exercised by commanders at any echelon at or below the level of combatant command. Operational control is inherent in combatant command (command authority). Operational control may be delegated and is the authority to perform those functions of command over subordinate forces involving organizing and employing commands and forces, assigning tasks, designating objectives, and giving authoritative direction necessary to accomplish the mission. Operational control includes authoritative direction over all aspects of military operations and joint training necessary to accomplish missions

assigned to the command. Operational control should be exercised through the commanders of subordinate organizations. Normally this authority is exercised through subordinate joint force commanders and Service and/or functional component commanders. Operational control normally provides full authority to organize commands and forces and to employ those forces as the commander in operational control considers necessary to accomplish assigned missions. Operational control does not, in and of itself, include authoritative direction for logistics or matters of administration, discipline, internal organization, or unit training. Also called OPCON. (JP 1-02)

operations center—The facility or location on an installation, base, or facility used by the commander to command, control, and coordinate all crisis activities. (JP 1-02)

order of battle—The identification, strength, command structure, and disposition of the personnel, units, and equipment of any military force. (JP 1-02)

ordnance—Explosives, chemicals, pyrotechnics, and similar stores, e.g., bombs, guns and ammunition, flares, smoke, napalm. (JP 1-02)

organic—Assigned to and forming an essential part of a military organization. Organic parts of a unit are those listed in its table of organization for the Army, Air Force, and Marine Corps, and are assigned to the administrative organizations of the operating forces for the Navy. (JP 1-02)

organization for combat—A process which places an artillery unit within an organization (i.e., establishes a command relationship) and assigns the unit a tactical mission.

orienting angle—A horizontal clockwise angle from the line of fire to the orienting line. (JP 1-02)

orienting line—A line of known direction in the battery area that serves as a basis for laying the battery for direction. The azimuth of the orienting line is the direction from the orienting station to a designated end of the orienting line.

orienting station—A point established on the ground which has directional control. The aiming circle is set up over this point to lay the pieces by the orienting angle method.

overlay—A printing or drawing on a transparent or semi-transparent medium at the same scale as a map, chart, etc., to show details not appearing or requiring special emphasis on the original. (JP 1-02)

parallel sheaf—In artillery and naval gunfire support, a sheaf in which the planes (lines) of fire of all pieces are parallel. See also converged sheaf; open sheaf; special sheaf. (JP 1-02)

planned target—In artillery and naval gunfire support, a target on which fire is prearranged. (JP 1-02)

point target—**1.** A target of such small dimension that it requires the accurate placement of ordnance in order to neutralize or destroy it. **2.** nuclear—A target in which the ratio of radius of damage to target radius is equal to or greater than five.

position area—An area that is occupied, or to be occupied, by an artillery unit with its elements disposed to provide artillery support. Position areas do not constitute a rigid restrictive area for the artillery unit. They should be considered only as guides to be followed as closely as the mission, terrain, and tactical situation permit.

prearranged fire—Fire that is formally planned and executed against targets or target areas of known location. Such fire is usually planned well in advance and is executed at a predetermined time or during a predetermined period of time. See also fire; on-call. (JP 1-02)

precision fire—Fire used for registration and for attack and destruction of point targets.

predicted fire—Fire that is delivered without adjustment. (JP 1-02)

primary position—The position from which a battery intends to perform its assigned mission.

priority of fire—Guidance to a fire support planner to organize and employ fire support means in

accordance with the relative importance of the maneuver unit's missions.

priority target—A target that firing units lay on while not engaged in a fire mission. It is designated as critical by a maneuver commander on the basis of type, location, or time sensitivity. Generally, one battery will be laid on each priority target (as with a final protective fire).

projectile—An object projected by an applied exterior force and continuing in motion by virtue of its own inertia, as a bullet, shell, or grenade. Also applied to rockets and to guided missiles. (JP 1-02)

quadrant elevation—The angle between the horizontal plane and the axis of the bore when the weapon is laid. (DOD only) It is the algebraic sum of the elevation, angle of site, and complementary angle of site. (JP 1-02)

radar—A radio detection device that provides information on range, azimuth and/or elevation of objects.

radar fire—Gunfire aimed at a target which is tracked by radar. See also fire. (JP 1-02)

radar report—A report used by the artillery to control and coordinate the use of the radars of the counterbattery radar platoon. The report is used by the counterbattery radar platoon and the controlling artillery unit.

radiation dose—The total amount of ionizing radiation absorbed by material or tissues, expressed in centigrays. (DOD only) The term radiation dose is often used in the sense of the exposure dose expressed in roentgens, which is a measure of the total amount of ionization that the quantity of radiation could produce in air. This could be distinguished from the absorbed dose, also given in rads, which represents the energy absorbed from the radiation per gram of specified body tissue. Further, the biological dose, in rems, is a measure of the biological effectiveness of the radiation exposure. (JP 1-02)

radiation dose rate—The radiation dose (dosage) absorbed per unit of time. (DOD only) A radiation dose rate can be set at some particular unit of time (e.g., H + 1 hour) and would be called H + 1 radiation dose rate. (JP 1-02)

radiation exposure state—The condition of a unit, or exceptionally an individual, deduced from the cumulative whole body radiation dose(s) received. It is expressed as a symbol which indicates the potential for future operations and the degree of risk if exposed to additional nuclear radiation. (JP 1-02)

radiation intensity—The radiation dose rate at a given time and place. It may be used, coupled with a figure, to denote the radiation intensity used at a given number of hours after a nuclear burst, e.g., RI-3 is the radiation intensity 3 hours after the time of burst. (JP 1-02)

radiation scattering—The diversion of radiation (thermal, electromagnetic, or nuclear) from its original path as a result of interaction or collisions with atoms, molecules, or larger particles in the atmosphere or other media between the source of the radiation (e.g., a nuclear explosion) and a point at some distance away. As a result of scattering, radiation (especially gamma rays and neutrons) will be received at such a point from many directions instead of only from the direction of the source. (JP 1-02)

radiation sickness—An illness resulting from excessive exposure to ionizing radiation. The earliest symptoms are nausea, vomiting, and diarrhea, which may be followed by loss of hair, hemorrhage, inflammation of the mouth and throat, and general loss of energy. (JP 1-02)

radioactive decay—The decrease in the radiation intensity of any radioactive material with respect to time. (JP 1-02)

raid—An operation, usually small scale, involving a swift penetration of hostile territory to secure information, confuse the enemy, or to destroy installations. It ends with a

planned withdrawal upon completion of the assigned mission. (JP 1-02)

rally point—A feature identifiable on the ground and on a map used for assembly and recovery of vehicles and personnel following an enemy attack. (JP 1-02)

rate of fire—The number of rounds fired per weapon per minute. (JP 1-02)

ready—The term used to indicate that a weapon(s) is loaded, aimed, and prepared to fire. (JP 1-02)

rear area—For any particular command, the area extending forward from its rear boundary to the rear of the area assigned to the next lower level of command. This area is provided primarily for the performance of support functions. (JP 1-02)

reconnaissance by fire—A method of reconnaissance in which fire is placed on a suspected enemy position to cause the enemy to disclose a presence by movement or return of fire. (JP 1-02)

reconnaissance, selection, and occupation of position—A procedure used by artillery units to assist the rapid and orderly movement of the artillery unit from a position area, assembly area, or a march column into a position from which it can deliver the fire support required to accomplish its mission.

record as target—In artillery and naval gunfire support, the order used to denote that the target is to be recorded for future engagement or reference. (JP 1-02)

registration—The adjustment of fire to determine firing data corrections. (JP 1-02)

registration fire—Fire delivered to obtain accurate data for subsequent effective engagement of targets. See also fire. (JP 1-02)

registration point—Terrain feature or other designated point on which fire is adjusted for the purpose of obtaining corrections to firing data. (JP 1-02)

reinforcing—In artillery usage, tactical mission in which one artillery unit augments the fire of another artillery unit. (JP 1-02)

release point (road)—A well-defined point on a route at which the elements composing a column return under the authority of their respective commanders, each one of these elements continuing its movement towards its own appropriate destination. (JP 1-02)

repeat—In artillery and naval gunfire support, an order or request to fire again the same number of rounds with the same method of fire. (JP 1-02)

rounds complete—In artillery and naval gunfire support, the term used to report that the number of rounds specified in fire for effect have been fired. See also shot. (JP 1-02)

rules of engagement—Directives issued by competent military authority which delineate the circumstances and limitations under which United States forces will initiate and/or continue combat engagement with other forces encountered. Also called ROE. (JP 1-02)

scheduled fire—A type of prearranged fire executed at a predetermined time. (JP 1-02)

scheduled target—In artillery and naval gunfire support, a planned target on which fire is to be delivered at a specific time. (JP 1-02)

schedule of fire—Groups of fires or series of fires fired in a definite sequence according to a definite program. The time of starting the schedule may be ON CALL. For identification purposes, schedules may be referred to by a code name or other designation. (JP 1-02)

schedule of targets—In artillery and naval gunfire support, individual targets, groups or series of targets to be fired on, in a definite sequence according to a definite program. (JP 1-02)

scheme of maneuver—The tactical plan to be executed by a force in order to seize assigned objectives. (JP 1-02)

screening fire—Fire delivered to mask friendly maneuver elements and to conceal the nature of their operations.

searching fire—Fire distributed in depth by successive changes in the elevation of a gun. See also fire. (JP 1-02)

sector—**1.** An area designated by boundaries within which a unit operates, and for which it is responsible. **2.** One of the subdivisions of a coastal frontier. (JP 1-02)

sector of fire—A defined area which is required to be covered by the fire of individual or crew served weapons or the weapons of a unit. (JP 1-02)

security area—The forward of the three echelons of a defensive sector. It is the area forward of the forward edge of the battle area out to the forward positions initially assigned to the security forces. The ground combat element commander may extend the lateral boundaries of subordinate units forward of the forward edge of the battle area, giving them responsibility for the security area within the sector to the forward limit of their boundaries, or he/she may assign a security force to operate across the entire ground combat element frontage. (MCRP 5-12C)

self-propelled weapon—A weapon that has its cannon permanently installed on a full tracked vehicle which provides its own automotive power.

semi-fixed ammunition—Ammunition in which the cartridge case is not permanently attached to the projectile. See also munition. (JP 1-02)

sensor—An equipment which detects, and may indicate, and/or record objects and activities by means of energy or particles emitted, reflected, or modified by objects. (JP 1-02)

separate loading ammunition—(JP 1-02) Ammunition in which the projectile and charge are loaded into a gun separately. See also munition. (JP 1-02)

serial—**1.** An element or a group of elements within a series which is given a numerical or alphabetical designation for convenience in planning, scheduling, and control (DOD only) **2.** Any number of aircraft under one commander, usually conveying one air-transportable unit or subunit to the same objective. (JP 1-02)

shear—In artillery and naval gunfire support, planned planes (lines) of fire that produce a desired pattern of bursts with rounds fired by two or more weapons.

shelling report—Any report of enemy shelling containing information on caliber, direction, time, density and area shelled. (JP 1-02)

shifting fire—Fire delivered at constant range at varying deflections; used to cover the width of a target that is too great to be covered by an open sheaf. (JP 1-02)

shot—In artillery and naval gunfire support, a report that indicates a gun, or guns, have been fired. See also rounds complete. (JP 1-02)

situation map—A map showing the tactical or the administrative situation at a particular time. (JP 1-02)

situation report—A report giving the situation in the area of a reporting unit or formation. Also called SITREP. (JP 1-02)

slant range—The line of sight distance between two points, not at the same level relative to a specific datum. (JP 1-02)

special ammunition supply point—A mobile supply point where special ammunition is stored and issued to delivery units. (JP 1-02)

special sheaf—In artillery and naval gunfire support, any sheaf other than parallel, converged, or open. (JP 1-02)

special staff—All staff officers having duties at a headquarters and not included in the general (coordinating) staff group or in the personal staff group. The special staff includes certain

technical specialists and heads of services, e.g., quartermaster officer, antiaircraft officer, transportation officer, etc. (JP 1-02)

splash—**1.** In artillery and naval gunfire support, word transmitted to an observer or spotter five seconds before the estimated time of the impact of a salvo or round. **2.** In air interception, target destruction verified by visual or radar means. (JP 1-02)

spot—**1.** To determine by observation, deviations of ordnance from the target for the purpose of supplying necessary information for the adjustment of fire. **2.** To place in a proper location (DOD only) **3.** An approved shipboard helicopter landing site. See also ordnance. (JP 1-02)

start point—A well-defined point on a route at which a movement of vehicles begins to be under the control of the commander of this movement. The first vehicle of a convoy crosses the start point at a specified time.

submunition—Any munition that, to perform its task, separates from a parent munition. (JP 1-02)

supplementary position—A position selected for accomplishment of a specific mission other than the primary mission.

support—**1.** The action of a force which aids, protects, complements, or sustains another force in accordance with a directive requiring such action. **2.** A unit which helps another unit in battle Aviation, artillery, or naval gunfire may be used as a support for infantry. **3.** A part of any unit held back at the beginning of an attack as a reserve. **4.** An element of a command which assists, protects, or supplies other forces in combat. (JP 1-02)

supported commander—The commander having primary responsibility for all aspects of a task assigned by the Joint Strategic Capabilities Plan or other joint operation planning authority. In the context of joint operation planning, this term refers to the commander who prepares operation plans or operation orders in response to requirements of the Chairman of the Joint Chiefs of Staff. (JP 1-02)

supporting artillery—Artillery which executes fire missions in support of a specific unit, usually infantry, but remains under the command of the next higher artillery commander. (JP 1-02)

supporting commander—A commander who provides augmentation forces or other support to a supported commander or who develops a supporting plan. Includes the designated combatant commands and Defense agencies as appropriate. (JP 1-02)

supporting fire—Fire delivered by supporting units to assist or protect a unit in combat. See also close supporting fire; deep supporting fire; direct supporting fire. (JP 1-02)

suppression—Temporary or transient degradation by an opposing force of the performance of a weapons system below the level needed to fulfill its mission objectives. (JP 1-02)

suppression mission—A mission to suppress an actual or suspected weapons system for the purpose of degrading its performance below the level needed to fulfill its mission objectives at a specific time for a specified duration. (JP 1-02)

suppression of enemy air defenses—That activity which neutralizes, destroys, or temporarily degrades surface-based enemy air defenses by destructive and/or disruptive means. Also called SEAD. (JP 1-02)

suppressive fire—(JP 1-02) Fires on or about a weapons system to degrade its performance below the level needed to fulfill its mission objectives, during the conduct of the fire mission. See also fire. (JP 1-02)

survey control point—A survey station used to coordinate survey control. (JP 1-02)

survey information center—A place where survey data are collected, correlated, and made available to subordinate units. (JP 1-02)

survivability move—A displacement for the purpose of increasing the artillery unit's chance of survival.

suspected target—A possible target that requires further correlation or additional information before it is considered a target.

sustained rate of fire—Actual rate of fire that a weapon can continue to deliver for an indefinite length of time without seriously overheating. (JP 1-02)

sweeping fire—A method of fire where weapons fire a constant quadrant elevation with several deflections in direct relation to the direction of fire.

tactical air command center—The principal US Marine Corps air command and control agency from which air operations and air defense warning functions are directed. It is the senior agency of the US Marine air command and control system which serves as the operational command post of the aviation combat element commander. It provides the facility from which the aviation combat element commander and his battle staff plan, supervise, coordinate, and execute all current and future air operations in support of the Marine air-ground task force. The tactical air command center can provide integration, coordination, and direction of joint and combined air operations. Also called Marine TACC. (JP 1-02)

tactical control—Command authority over assigned or attached forces or commands, or military capability or forces made available for tasking, that is limited to the detailed and, usually, local direction and control of movements or maneuvers necessary to accomplish missions or tasks assigned. Tactical control is inherent in operational control. Tactical control may be delegated to, and exercised at any level at or below the level of combatant command. Also called TACON. (JP 1-02)

tactical fire direction—The control of one or more units in the selection of targets to attack, designation of the unit or units to fire, selection of the method of attack, and selection of the most suitable ammunition for the mission.

tactical map—A large-scale map used for tactical and administrative purposes. (JP 1-02)

tactical march—The movement of a unit or an element under actual or simulated combat conditions.

tactical mission—Defines the fire support responsibility of an artillery unit, normally a battalion, to a supported unit or to another artillery unit.

tactics—**1.** The employment of units in combat. **2.** The ordered arrangement and maneuver of units in relation to each other and/or to the enemy in order to use their full potentialities. (JP 1-02)

target—**1.** A geographical area, complex, or installation planned for capture or destruction by military forces. **2.** In intelligence usage, a country, area, installation, agency, or person against which intelligence operations are directed. **3.** An area designated and numbered for future firing **4.** In gunfire support usage, an impact burst which hits the target. See also objective area. (JP 1-02)

target acquisition—The detection, identification, and location of a target in sufficient detail to permit the effective employment of weapons. See also target analysis. (JP 1-02)

target analysis—An examination of potential targets to determine military importance, priority of attack, and weapons required to obtain a desired level of damage or casualties. See also target acquisition. (JP 1-02)

target category—Those categories used to facilitate the processing of target data, particularly the maintenance of counterfire target files.

targeting—**1.** The process of selecting targets and matching the appropriate response to them, taking account of operational requirements and capabilities. **2.** The analysis of enemy situations relative to the commander's mission, objectives, and capabilities at the commander's disposal, to identify and nominate specific vulnerabilities that, if exploited, will accomplish the commander's purpose through delaying, disrupting,

disabling, or destroying enemy forces or resources critical to the enemy. (JP 1-02)

target list—The listing of targets maintained and promulgated by the senior echelon of command; it contains those targets that are to be engaged by supporting arms, as distinguished from a "list of targets" that may be maintained by any echelon as confirmed, suspected, or possible targets for informational and planning purposes. See also list of targets. (JP 1-02)

target of opportunity—**1.** A target visible to a surface or air sensor or observer, which is within range of available weapons and against which fire has not been scheduled or requested. **2.** nuclear—A nuclear target observed or detected after an operation begins that has not been previously considered, analyzed or planned for a nuclear strike. Generally fleeting in nature, it should be attacked as soon as possible within the time limitations imposed for coordination and warning of friendly troops and aircraft. (JP 1-02)

target overlay—A transparent sheet which, when superimposed on a particular chart, map, drawing, tracing or other representation, depicts target locations and designations. The target overlay may also show boundaries between maneuver elements, objectives and friendly forward dispositions.

target prediction—Predicting a target's existence and location by analyzing available combat information and intelligence.

target selection standards—Criteria established by the G-2/S-2 of the supported unit to determine if data is a target or a suspected target. The standards are based on the enemy's demonstrated use of deception and the susceptibility of our collective systems to such deception. The artillery S-2 makes recommendations on the establishment.

target value analysis—A method for providing a systematic determination of which target out of the entire target array should be attacked for the greatest tactical benefit.

technical fire direction—The conversion of requests for fire to appropriate firing data and fire commands.

terrain march—An off-road movement.

time of flight—In artillery and naval gunfire support, the time in seconds from the instant a weapon is fired, launched, or released from the delivery vehicle or weapons system to the instant it strikes or detonates. (JP 1-02)

time on target—**1.** Time at which aircraft are scheduled to attack/photograph the target. **2.** The actual time at which aircraft attack/photograph the target. **3.** The time at which a nuclear detonation is planned at a specified desired ground zero. (JP 1-02)

towed weapon—A weapon which must be moved by an external prime mover, such as a truck or a tractor. The weapon is detached from the prime mover for firing.

trig list—A list published by certain Army units which includes essential information of accurately located survey points. (JP 1-02)

unmanned aerial vehicle—A powered, aerial vehicle that does not carry a human operator,

uses aerodynamic forces to provide vehicle lift, can fly autonomously or be piloted remotely, can be expendable or recoverable, and can carry a lethal or nonlethal payload. Ballistic or semiballistic vehicles, cruise missiles, and artillery projectiles are not considered unmanned aerial vehicles. Also called UAV.

unobserved fire—Fire for which the points of impact or burst are not observed. See also fire. (JP 1-02)

zone and sweep fire—A method of fire which combines zone fire and sweeping fire, and is valuable in attacking large, regular-shaped targets.

zone fire—Artillery or mortar fires that are delivered in a constant direction at several quadrant elevations. See also fire. (JP 1-02)

zone of action—A tactical subdivision of a larger area, the responsibility for which is assigned to a tactical unit; generally applied to offensive action. See also sector. (JP 1-02)

zone of fire—An area into which a designated ground unit or fire support ship delivers, or is prepared to deliver, fire support. Fire may or may not be observed. See also contingent zone of fire. (JP 1-02)

APPENDIX H

REFERENCES AND RELATED PUBLICATIONS

Joint Publications (JPs)

1-02	Department of Defense Dictionary of Military and Associated Terms
3-02.2	Joint Doctrine for Amphibious Embarkation
3-09	Doctrine for Joint Fire Support

Marine Corps Doctrinal Publications (MCDPs)

1	Warfighting
1-0	Marine Corps Operations
1-1	Strategy
1-2	Campaigning
1-3	Tactics
2	Intelligence
3	Expeditionary Operations
4	Logistics
5	Planning
6	Command and Control

Marine Corps Warfighting Publications (MCWPs)

2-12	MAGTF Intelligence Production and Analysis
3-1	Ground Combat Operations
3-11.3	Scouting and Patrolling
3-16	Fire Support Coordination in the Ground Support Element
3-16.3	Tactics, Techniques, and Procedures for the Field Artillery Cannon Battery
3-16.4	Tactics, Techniques, and Procedures for Field Artillery Manual Cannon Gunnery
3-16.5	Field Artillery Meteorology
3-16.6	Supporting Arms Observer, Spotter, and Controller
3-16.7	Marine Artillery Survey
3-17.1	River-Crossing Operations
3-22.2	Suppression of Enemy Air Defenses (SEAD)
3-23	Offensive Air Support (OAS)
3-23.1	Close Air Support
3-23.2	Deep Air Support
3-24	Assault Support
3-25.3	Marine Air Command and Control System Handbook
3-25.4	Marine Tactical Air Command Center Handbook
3-25.5	Direct Air Support Center Handbook
3-25.4	Doctrine for Navy/Marine Joint Riverine Operations
3-35.5	Jungle Operations
3-35.6	Desert Operations

3-37	MAGTF Nuclear, Biological, and Chemical Defense Operations
3-37.1	Chemical Operations Principles and Fundamentals
3-37.2	NBC Protection
3-37.3	Nuclear, Biological, and Chemical Decontamination
4-11	Tactical Level Logistics
5-1	Marine Corps Planning Process

Marine Corps Reference Publications (MCRPs)

3-16A	Tactics, Techniques, and Procedures for the Targeting Process
3-16B	The Joint Targeting Process and Procedures for Time-Critical Targets
3-16.1C	Tactics, Techniques, and Procedures for Multiple Launch Rocket System (MLRS) Operations
3-16.5A	Meteorology Tables
3-16.6A	Multi-Service Procedures for the Joint Application of Firepower (J-Fires)
3-16.7A	Army Ephemeris
3-37A	Nuclear, Biological, and Chemical Field Handbook
3-37B	Field Behavior for Nuclear, Biological, and Chemical Agents
3-37.2A	Chemical and Biological Contamination Avoidance
4-11.3E Vol-1	Multi-Service Helicopter Sling Load: Basic Operations and Equipment
4-11.3E Vol-2	Multi-Service Helicopter Sling Load: Single-Point Rigging Procedures
5-12A	Operational Terms and Graphics

Fleet Marine Force Manuals (FMFMs)

6-18.1	Tactics, Techniques, and Procedures for the Marine Corps Fire Support System
6-21	Tactical Fundamentals of Helicopterborne Operations
7-32	Raid Operations

Marine Corps Order (MCO)

8010.1E	Class V(W) Planning Factors for Fleet Marine Combat Operations Force
---------	--

Army Field Manuals (FMs)

6-121	Multi-Service Tactics, Techniques, and Procedures for Field Artillery Target Acquisition
10-500-53	Airdrop of Supplies and Equipment: Rigging Ammunition
10-527	Airdrop of Supplies and Equipment: Rigging of 155-MM Howitzer
11-1	Multi-Service Procedures for the Single-Channel Ground and Airborne Radio System
24-18	Tactical Single-Channel Radio Communications Techniques

Websites

General Dennis J. Reimer Training and Doctrine Digital Library home page—
<http://155.217.58.58/atdls.htm>

Marine Corps Combat Development Command, Quantico, VA home page—
<http://www.mccdc.usmc.mil>

Combined Arms Center, Ft. Leavenworth, KS home page—
<http://leav-www.army.mil/>

Expeditionary Warfare Training Group, Pacific (EWTGPAC) home page—
<http://www.ewtgpac.navy.mil/>

Federation of American Scientist (FAS) Military Analysis Network home page—
<http://fas.org/man/>

Fort Sill, OK home page—
<http://sill-www.army.mil/index.htm>

Jane's Defence Weekly—
<http://jdw.janes.com/>

Joint Development Training Center (JDTC) home page—
<http://www.jdtdc.eustis.army.mil/>

Joint Electronic Library Homepage—
<http://www.dtic.mil/doctrine/>

Marine Corps Doctrine Division, Quantico, VA home page—
<http://www.doctrine.usmc.mil/>

Marine Corps Doctrine Links—
<http://www.doctrine.usmc.mil/links.htm>

Naval Warfare Development Command (NWDC) home page—
<http://www.nwdc.navy.mil/>

U.S. Army Training and Doctrine Command home page—
<http://www-tradoc.army.mil/>

APPENDIX H

REFERENCES AND RELATED PUBLICATIONS

Joint Publications (JPs)

1-02	Department of Defense Dictionary of Military and Associated Terms
3-02.2	Joint Doctrine for Amphibious Embarkation
3-09	Doctrine for Joint Fire Support

Marine Corps Doctrinal Publications (MCDPs)

1	Warfighting
1-0	Marine Corps Operations
1-1	Strategy
1-2	Campaigning
1-3	Tactics
2	Intelligence
3	Expeditionary Operations
4	Logistics
5	Planning
6	Command and Control

Marine Corps Warfighting Publications (MCWPs)

2-12	MAGTF Intelligence Production and Analysis
3-1	Ground Combat Operations
3-11.3	Scouting and Patrolling
3-16	Fire Support Coordination in the Ground Support Element
3-16.3	Tactics, Techniques, and Procedures for the Field Artillery Cannon Battery
3-16.4	Tactics, Techniques, and Procedures for Field Artillery Manual Cannon Gunnery
3-16.5	Field Artillery Meteorology
3-16.6	Supporting Arms Observer, Spotter, and Controller
3-16.7	Marine Artillery Survey
3-17.1	River-Crossing Operations
3-22.2	Suppression of Enemy Air Defenses (SEAD)
3-23	Offensive Air Support (OAS)
3-23.1	Close Air Support
3-23.2	Deep Air Support
3-24	Assault Support
3-25.3	Marine Air Command and Control System Handbook
3-25.4	Marine Tactical Air Command Center Handbook
3-25.5	Direct Air Support Center Handbook
3-25.4	Doctrine for Navy/Marine Joint Riverine Operations
3-35.5	Jungle Operations
3-35.6	Desert Operations

3-37	MAGTF Nuclear, Biological, and Chemical Defense Operations
3-37.1	Chemical Operations Principles and Fundamentals
3-37.2	NBC Protection
3-37.3	Nuclear, Biological, and Chemical Decontamination
4-11	Tactical Level Logistics
5-1	Marine Corps Planning Process

Marine Corps Reference Publications (MCRPs)

3-16A	Tactics, Techniques, and Procedures for the Targeting Process
3-16B	The Joint Targeting Process and Procedures for Time-Critical Targets
3-16.1C	Tactics, Techniques, and Procedures for Multiple Launch Rocket System (MLRS) Operations
3-16.5A	Meteorology Tables
3-16.6A	Multi-Service Procedures for the Joint Application of Firepower (J-Fires)
3-16.7A	Army Ephemeris
3-37A	Nuclear, Biological, and Chemical Field Handbook
3-37B	Field Behavior for Nuclear, Biological, and Chemical Agents
3-37.2A	Chemical and Biological Contamination Avoidance
4-11.3E Vol-1	Multi-Service Helicopter Sling Load: Basic Operations and Equipment
4-11.3E Vol-2	Multi-Service Helicopter Sling Load: Single-Point Rigging Procedures
5-12A	Operational Terms and Graphics

Fleet Marine Force Manuals (FMFMs)

6-18.1	Tactics, Techniques, and Procedures for the Marine Corps Fire Support System
6-21	Tactical Fundamentals of Helicopterborne Operations
7-32	Raid Operations

Marine Corps Order (MCO)

8010.1E	Class V(W) Planning Factors for Fleet Marine Combat Operations Force
---------	--

Army Field Manuals (FMs)

6-121	Multi-Service Tactics, Techniques, and Procedures for Field Artillery Target Acquisition
10-500-53	Airdrop of Supplies and Equipment: Rigging Ammunition
10-527	Airdrop of Supplies and Equipment: Rigging of 155-MM Howitzer
11-1	Multi-Service Procedures for the Single-Channel Ground and Airborne Radio System
24-18	Tactical Single-Channel Radio Communications Techniques

Websites

General Dennis J. Reimer Training and Doctrine Digital Library home page—
<http://155.217.58.58/atdls.htm>

Marine Corps Combat Development Command, Quantico, VA home page—
<http://www.mccdc.usmc.mil>

Combined Arms Center, Ft. Leavenworth, KS home page—
<http://leav-www.army.mil/>

Expeditionary Warfare Training Group, Pacific (EWTGPAC) home page—
<http://www.ewtgpac.navy.mil/>

Federation of American Scientist (FAS) Military Analysis Network home page—
<http://fas.org/man/>

Fort Sill, OK home page—
<http://sill-www.army.mil/index.htm>

Jane's Defence Weekly—
<http://jdw.janes.com/>

Joint Development Training Center (JDTC) home page—
<http://www.jdtc.eustis.army.mil/>

Joint Electronic Library Homepage—
<http://www.dtic.mil/doctrine/>

Marine Corps Doctrine Division, Quantico, VA home page—
<http://www.doctrine.usmc.mil/>

Marine Corps Doctrine Links—
<http://www.doctrine.usmc.mil/links.htm>

Naval Warfare Development Command (NWDC) home page—
<http://www.nwdc.navy.mil/>

U.S. Army Training and Doctrine Command home page—
<http://www-tradoc.army.mil/>

APPENDIX H

REFERENCES AND RELATED PUBLICATIONS

Joint Publications (JPs)

1-02	Department of Defense Dictionary of Military and Associated Terms
3-02.2	Joint Doctrine for Amphibious Embarkation
3-09	Doctrine for Joint Fire Support

Marine Corps Doctrinal Publications (MCDPs)

1	Warfighting
1-0	Marine Corps Operations
1-1	Strategy
1-2	Campaigning
1-3	Tactics
2	Intelligence
3	Expeditionary Operations
4	Logistics
5	Planning
6	Command and Control

Marine Corps Warfighting Publications (MCWPs)

2-12	MAGTF Intelligence Production and Analysis
3-1	Ground Combat Operations
3-11.3	Scouting and Patrolling
3-16	Fire Support Coordination in the Ground Support Element
3-16.3	Tactics, Techniques, and Procedures for the Field Artillery Cannon Battery
3-16.4	Tactics, Techniques, and Procedures for Field Artillery Manual Cannon Gunnery
3-16.5	Field Artillery Meteorology
3-16.6	Supporting Arms Observer, Spotter, and Controller
3-16.7	Marine Artillery Survey
3-17.1	River-Crossing Operations
3-22.2	Suppression of Enemy Air Defenses (SEAD)
3-23	Offensive Air Support (OAS)
3-23.1	Close Air Support
3-23.2	Deep Air Support
3-24	Assault Support
3-25.3	Marine Air Command and Control System Handbook
3-25.4	Marine Tactical Air Command Center Handbook
3-25.5	Direct Air Support Center Handbook
3-25.4	Doctrine for Navy/Marine Joint Riverine Operations
3-35.5	Jungle Operations
3-35.6	Desert Operations

3-37	MAGTF Nuclear, Biological, and Chemical Defense Operations
3-37.1	Chemical Operations Principles and Fundamentals
3-37.2	NBC Protection
3-37.3	Nuclear, Biological, and Chemical Decontamination
4-11	Tactical Level Logistics
5-1	Marine Corps Planning Process

Marine Corps Reference Publications (MCRPs)

3-16A	Tactics, Techniques, and Procedures for the Targeting Process
3-16B	The Joint Targeting Process and Procedures for Time-Critical Targets
3-16.1C	Tactics, Techniques, and Procedures for Multiple Launch Rocket System (MLRS) Operations
3-16.5A	Meteorology Tables
3-16.6A	Multi-Service Procedures for the Joint Application of Firepower (J-Fires)
3-16.7A	Army Ephemeris
3-37A	Nuclear, Biological, and Chemical Field Handbook
3-37B	Field Behavior for Nuclear, Biological, and Chemical Agents
3-37.2A	Chemical and Biological Contamination Avoidance
4-11.3E Vol-1	Multi-Service Helicopter Sling Load: Basic Operations and Equipment
4-11.3E Vol-2	Multi-Service Helicopter Sling Load: Single-Point Rigging Procedures
5-12A	Operational Terms and Graphics

Fleet Marine Force Manuals (FMFMs)

6-18.1	Tactics, Techniques, and Procedures for the Marine Corps Fire Support System
6-21	Tactical Fundamentals of Helicopterborne Operations
7-32	Raid Operations

Marine Corps Order (MCO)

8010.1E	Class V(W) Planning Factors for Fleet Marine Combat Operations Force
---------	--

Army Field Manuals (FMs)

6-121	Multi-Service Tactics, Techniques, and Procedures for Field Artillery Target Acquisition
10-500-53	Airdrop of Supplies and Equipment: Rigging Ammunition
10-527	Airdrop of Supplies and Equipment: Rigging of 155-MM Howitzer
11-1	Multi-Service Procedures for the Single-Channel Ground and Airborne Radio System
24-18	Tactical Single-Channel Radio Communications Techniques

Websites

General Dennis J. Reimer Training and Doctrine Digital Library home page—
<http://155.217.58.58/atdls.htm>

Marine Corps Combat Development Command, Quantico, VA home page—
<http://www.mccdc.usmc.mil>

Combined Arms Center, Ft. Leavenworth, KS home page—
<http://leav-www.army.mil/>

Expeditionary Warfare Training Group, Pacific (EWTGPAC) home page—
<http://www.ewtgpac.navy.mil/>

Federation of American Scientist (FAS) Military Analysis Network home page—
<http://fas.org/man/>

Fort Sill, OK home page—
<http://sill-www.army.mil/index.htm>

Jane's Defence Weekly—
<http://jdw.janes.com/>

Joint Development Training Center (JDTC) home page—
<http://www.jdtdc.eustis.army.mil/>

Joint Electronic Library Homepage—
<http://www.dtic.mil/doctrine/>

Marine Corps Doctrine Division, Quantico, VA home page—
<http://www.doctrine.usmc.mil/>

Marine Corps Doctrine Links—
<http://www.doctrine.usmc.mil/links.htm>

Naval Warfare Development Command (NWDC) home page—
<http://www.nwdc.navy.mil/>

U.S. Army Training and Doctrine Command home page—
<http://www-tradoc.army.mil/>

To Our Readers

Changes: Readers of this publication are encouraged to submit suggestions and changes to Doctrine Branch via e-mail: doctrine@usmc.mil.

Suggestions and changes must include the following information:

- Location of change
 - Publication number and title
 - Current page number
 - Paragraph number (if applicable)
 - Line number
 - Figure or table number (if applicable)
- Nature of change
 - Addition/deletion of text
 - Proposed new text

Additional copies: If this publication is not an electronic only distribution, a printed copy may be obtained from Marine Corps Logistics Base, Albany, GA 31704-5001, by following the instructions in MCBul 5600, *Marine Corps Doctrinal Publications Status*. An electronic copy may be obtained from the United States Marine Corps Doctrine web page:

<https://homeport.usmc.mil/sites/mcdoctrine/SitePages/Home.aspx>